

Standardised Water Pump and Hot  
Water Pump

**50 Hz**

**Volcano**

Vlet - Vleta

**Characteristic Curves Booklet**

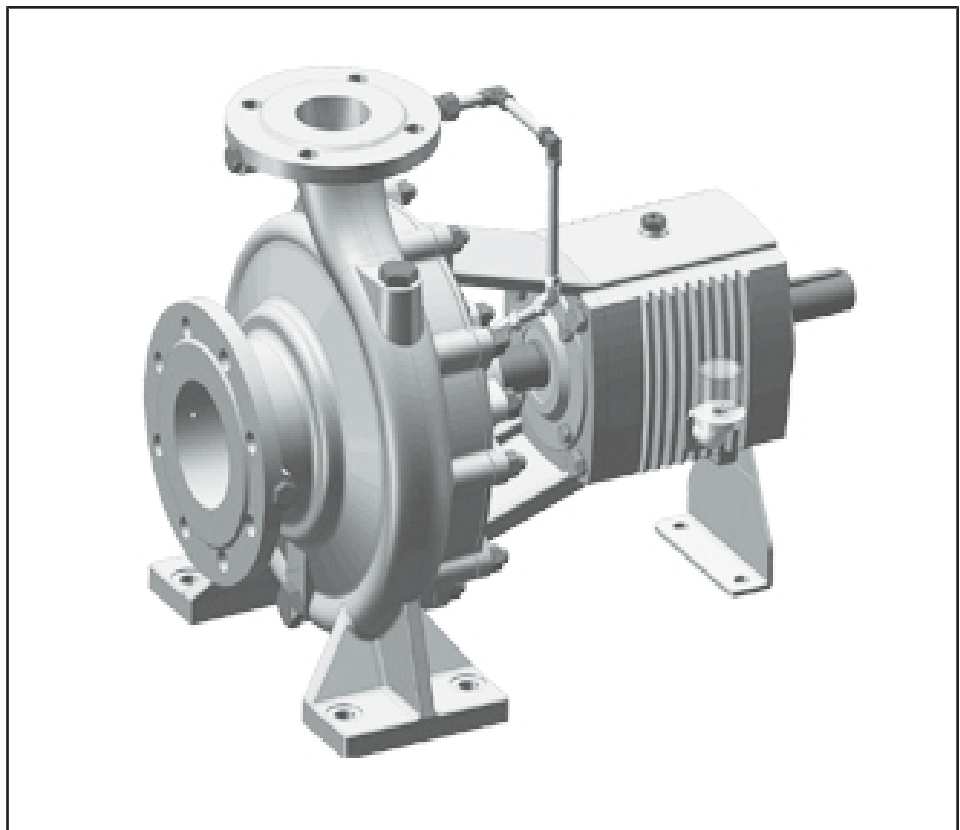

## Contents

### Centrifugal Pumps with Shaft Seal.

General . . . . .	3
Selection chart n=2900 . . . . .	4
Selection chart n=1450 . . . . .	5
Selection chart n=960 . . . . .	6
Chart Vlet n=2900 . . . . .	7
Chart Vlet n=1450 . . . . .	41
Chart Vlet N=950 . . . . .	103
Dimension . . . . .	165
Assembly drawing . . . . .	166
Pump exploded . . . . .	167

### **Pump case**

The pump case is of rigid design with a generous wall thickness, giving good protection against erosion and corrosion.

### **Shaft sealing**

Shaft sealing can be with:  
- soft packing  
- mechanical seal.

### **Shaft bearing bracket**

The heavy duty console with incorporated lantern assures silent operation.

### **Impeller**

Fully enclosed, single -piece casting gives reliability, long trouble-free operation and high efficiency.

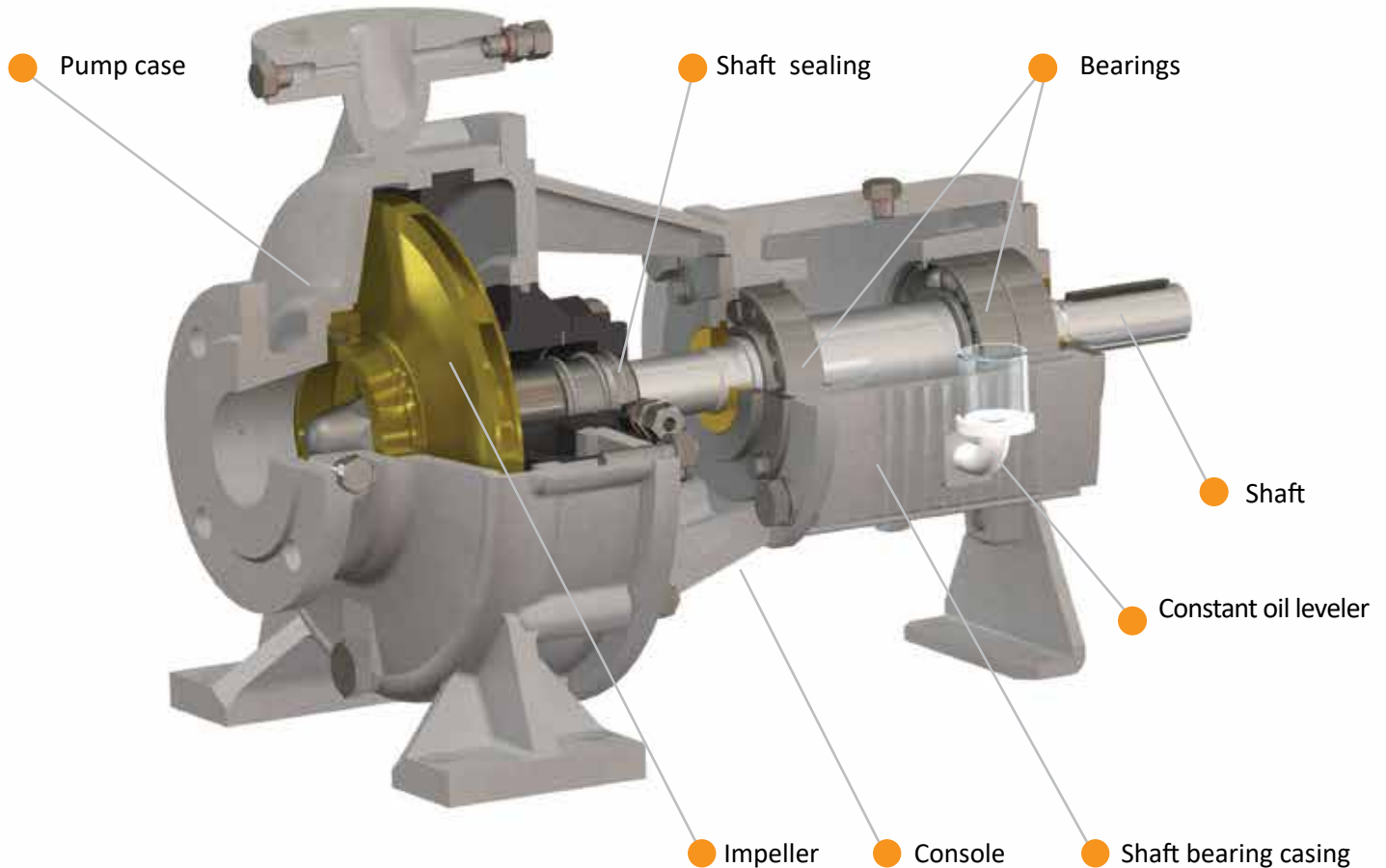

### **Bearings**

The shaft is protected by a replaceable shaft sleeve in stainless steel.

### **Shafts**

Ample dimensioned single and double row ball bearings improve the stiffness and minimize shaft deflection.

### **Console**

Aligned between the bearing bracket and the pump case.

### **Constant oil level**

For maintaining a constant oil level for efficient lubrication of the bearings.

### **Technical data:**

Capacity: up to 1368 m<sup>3</sup>/h  
Head: up to 160 m  
Pump size: up to DN300  
Temperature: up to 160°C  
Pressure: 16 bar

Selection charts

Vlet , Velta, n = 2900  
rpm

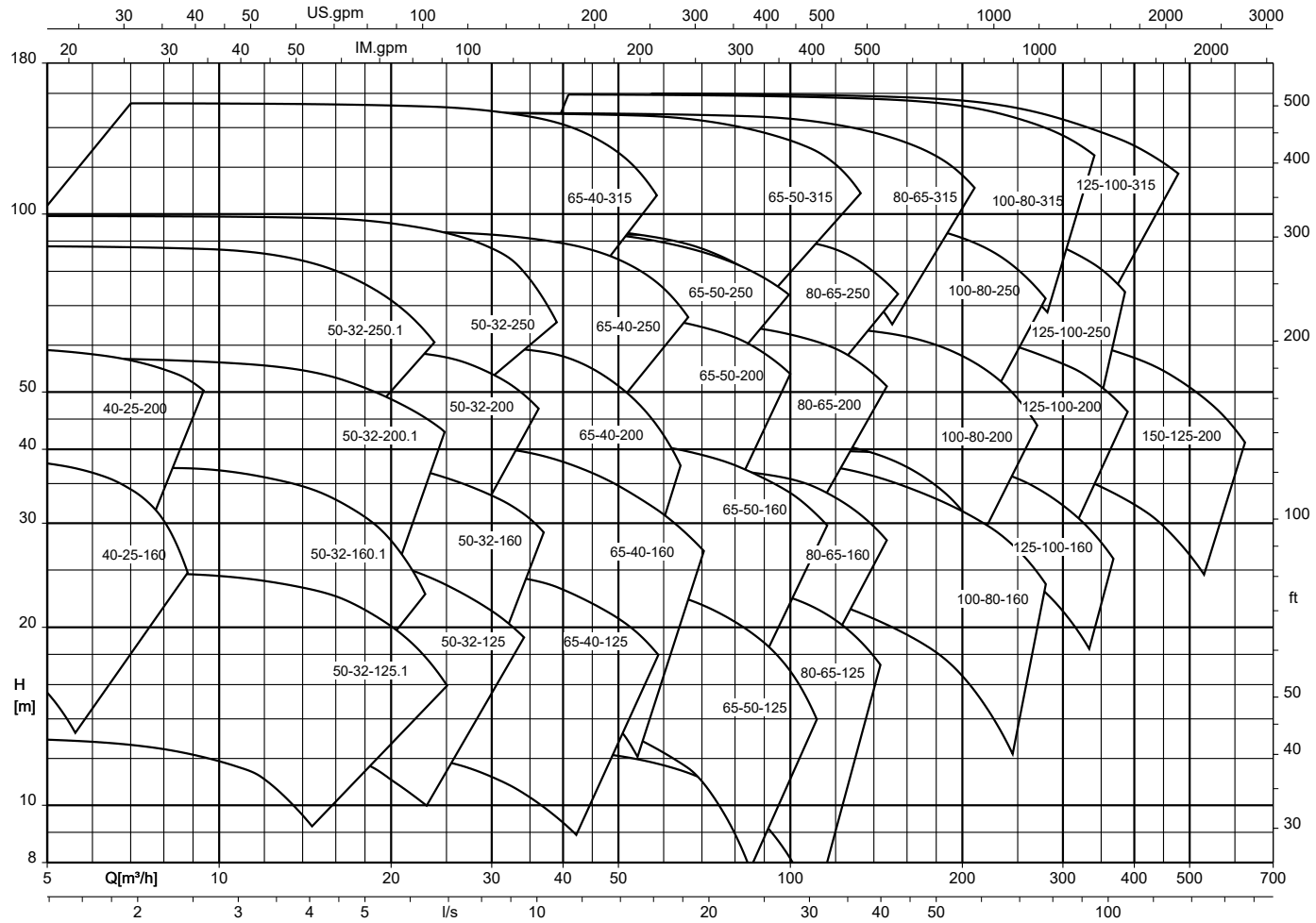

Vlet, Velta n = 1450 rpm

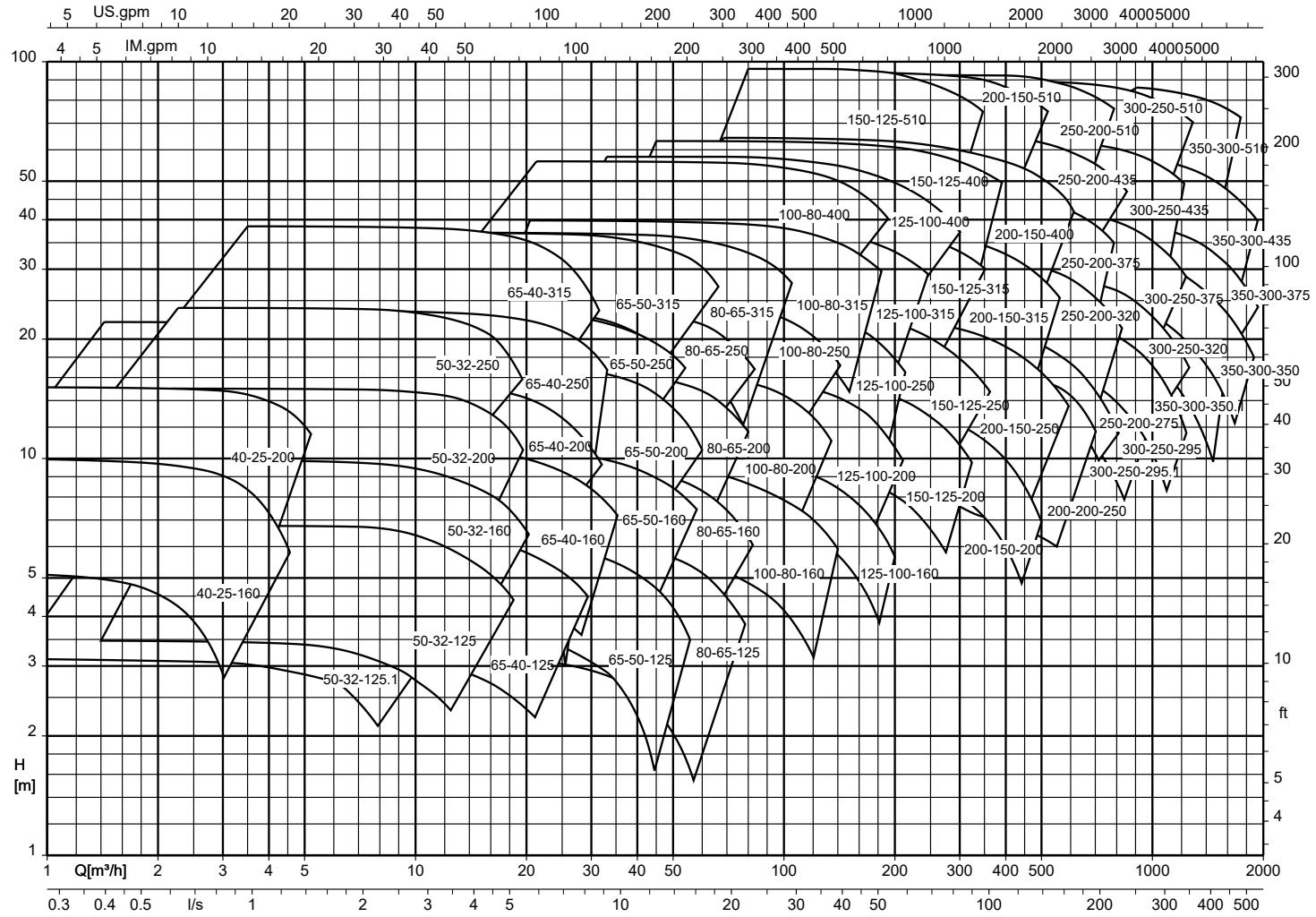

Centrifugal Pumps with Shaft Seal  
Standardised Water Pump / Thermal Oil and Hot Water Pump

Vlet, Velta n = 960 rpm

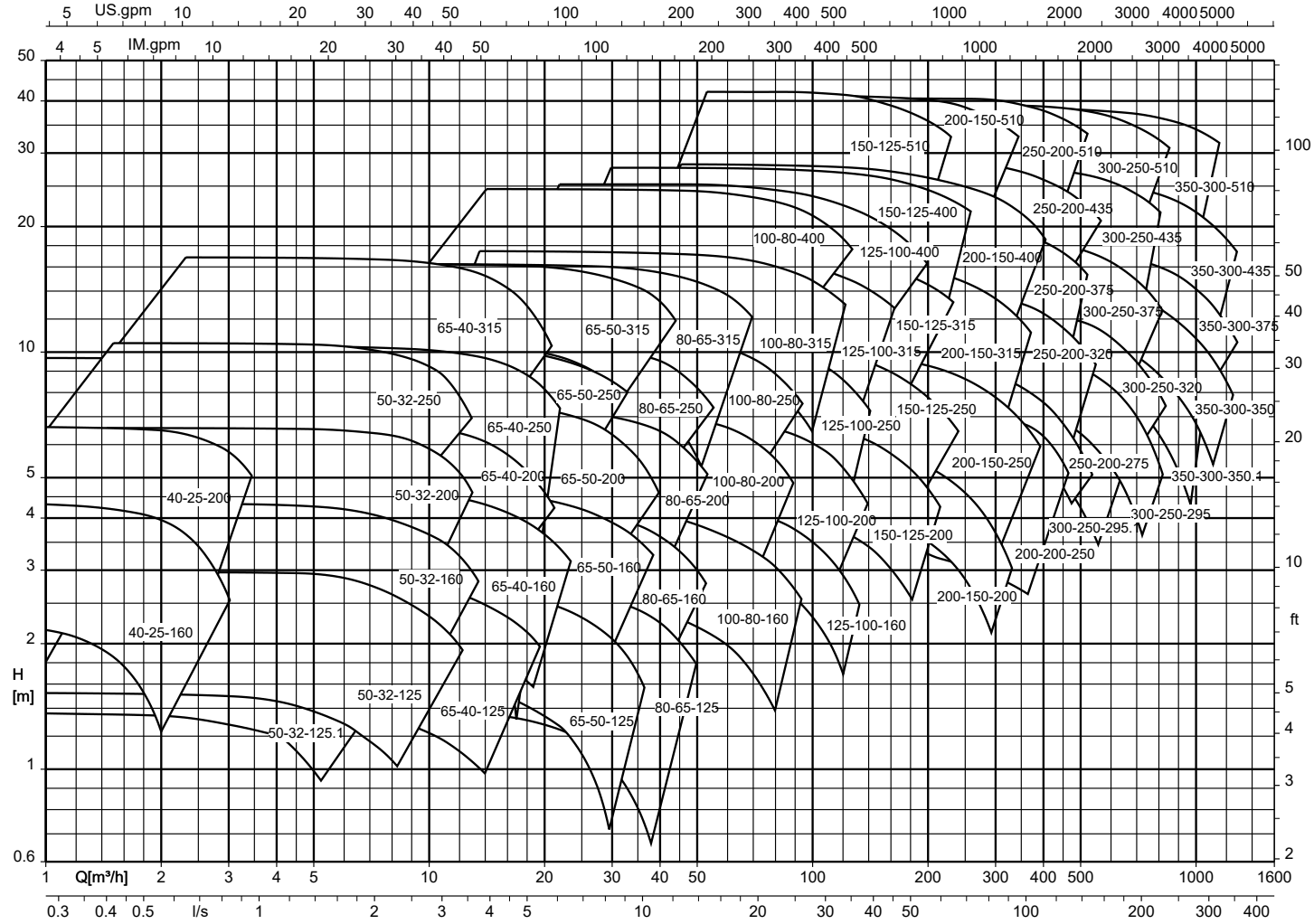

Characteristic curves

n = 2900 rpm

Vlet , Velta 040-025-160, n = 2900 rpm

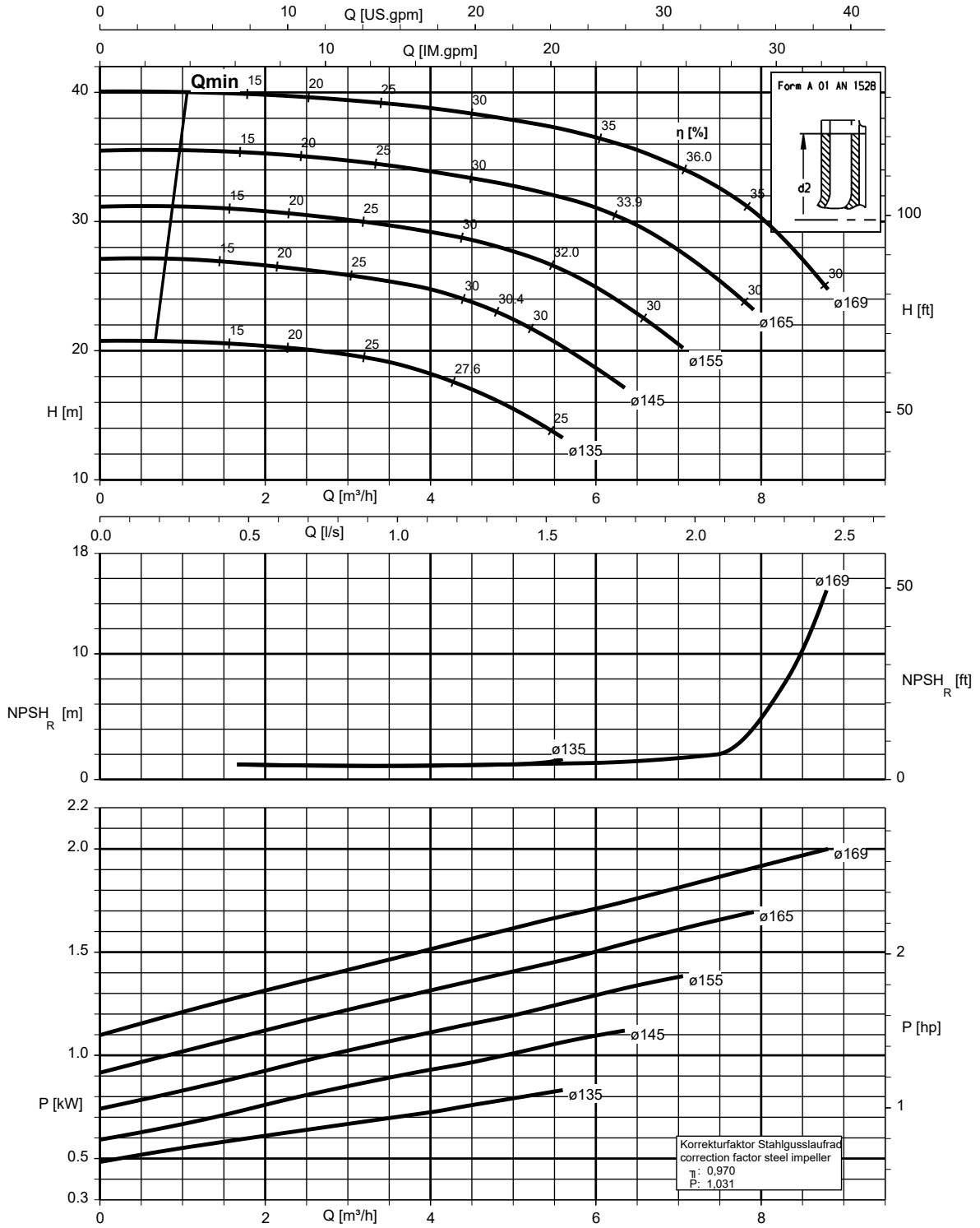

K1311.452/14/2

1311.45/11-EN

Vlet , Velta 040-025-200, n = 2900 rpm

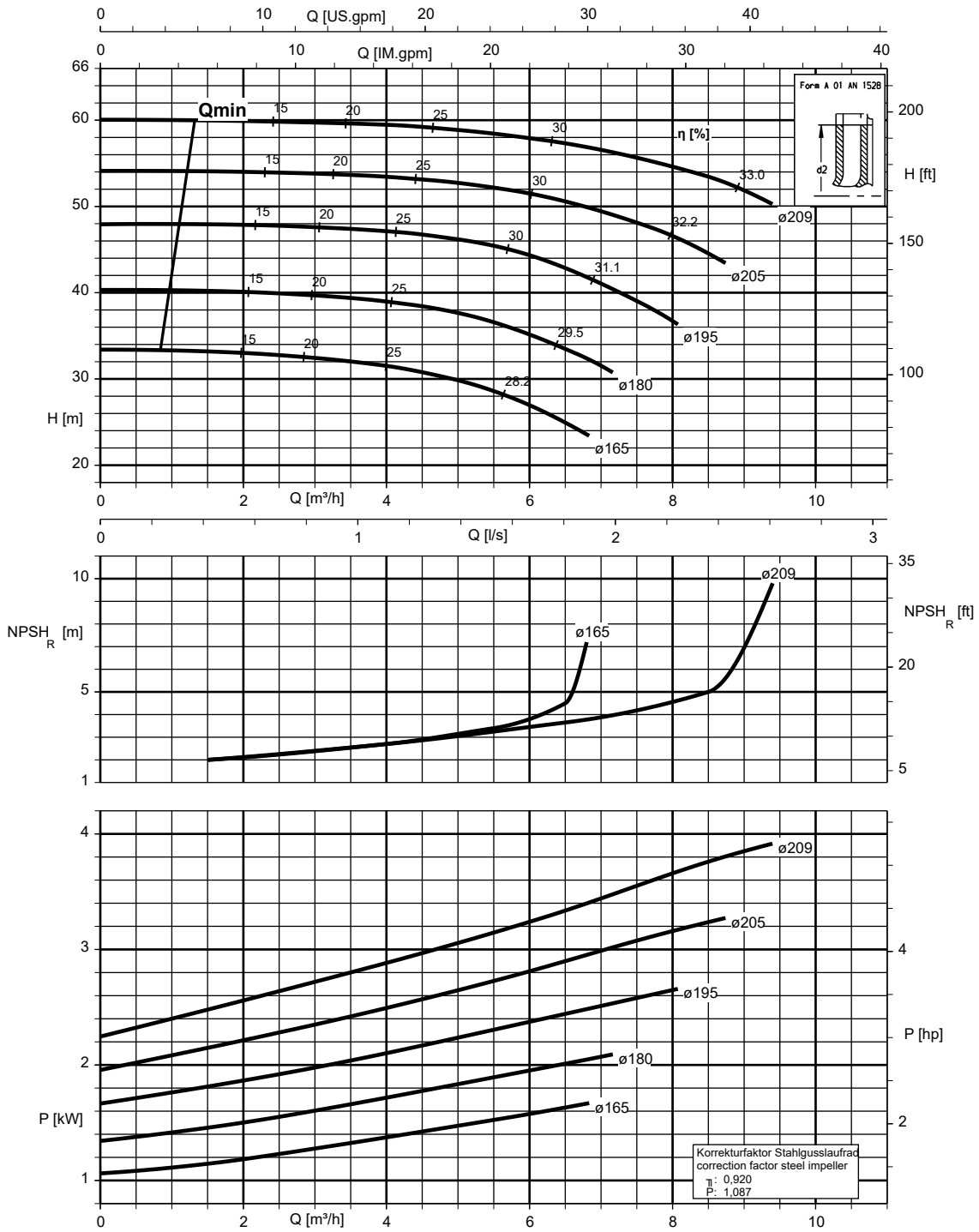

K1311/452/15/2



Vlet , Velta 050-032-125.1, n = 2900 rpm

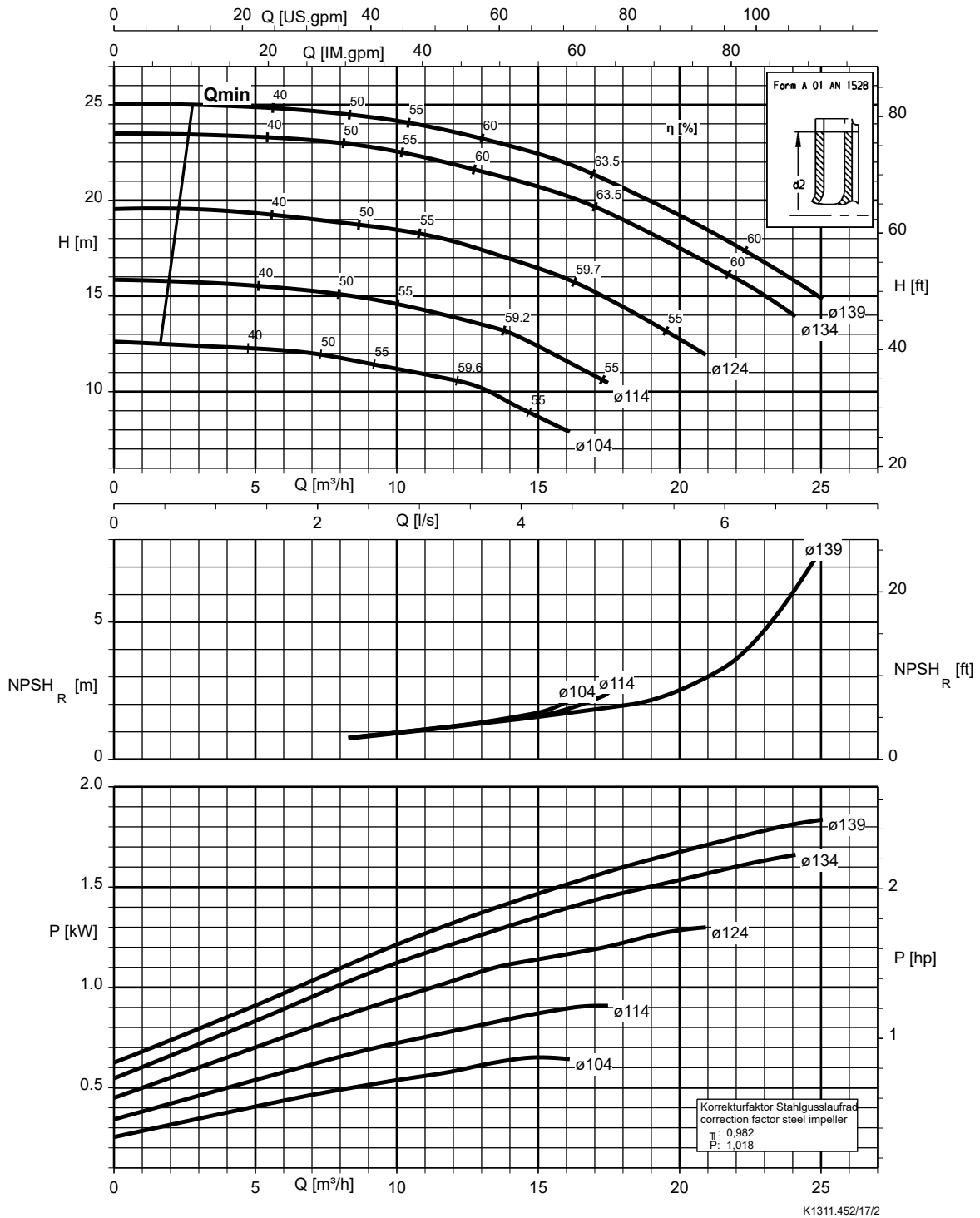

Vlet , Velta 050-032-160.1, n = 2900 rpm

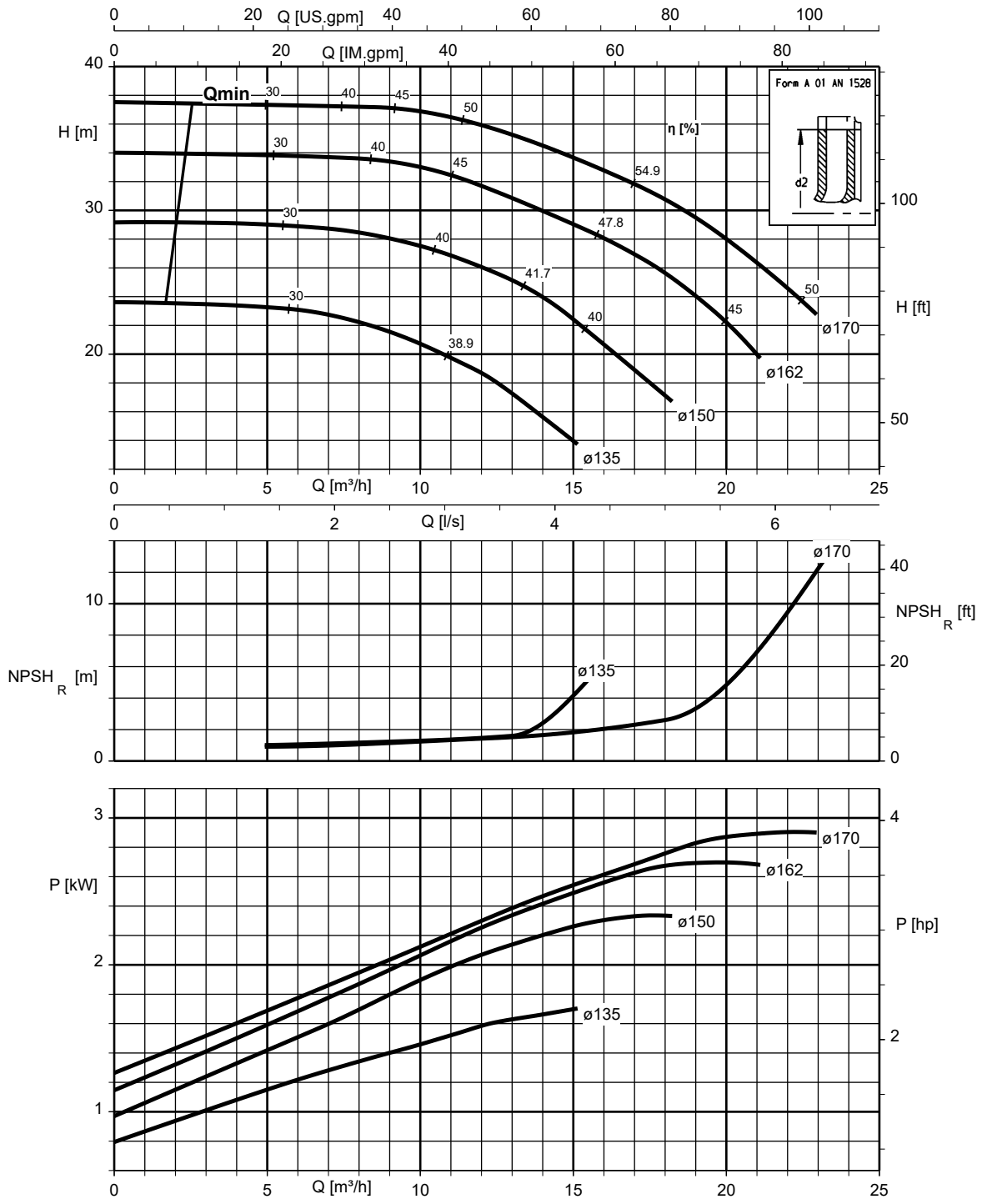

Vlet , Velta 050-032-200.1, n = 2900 rpm

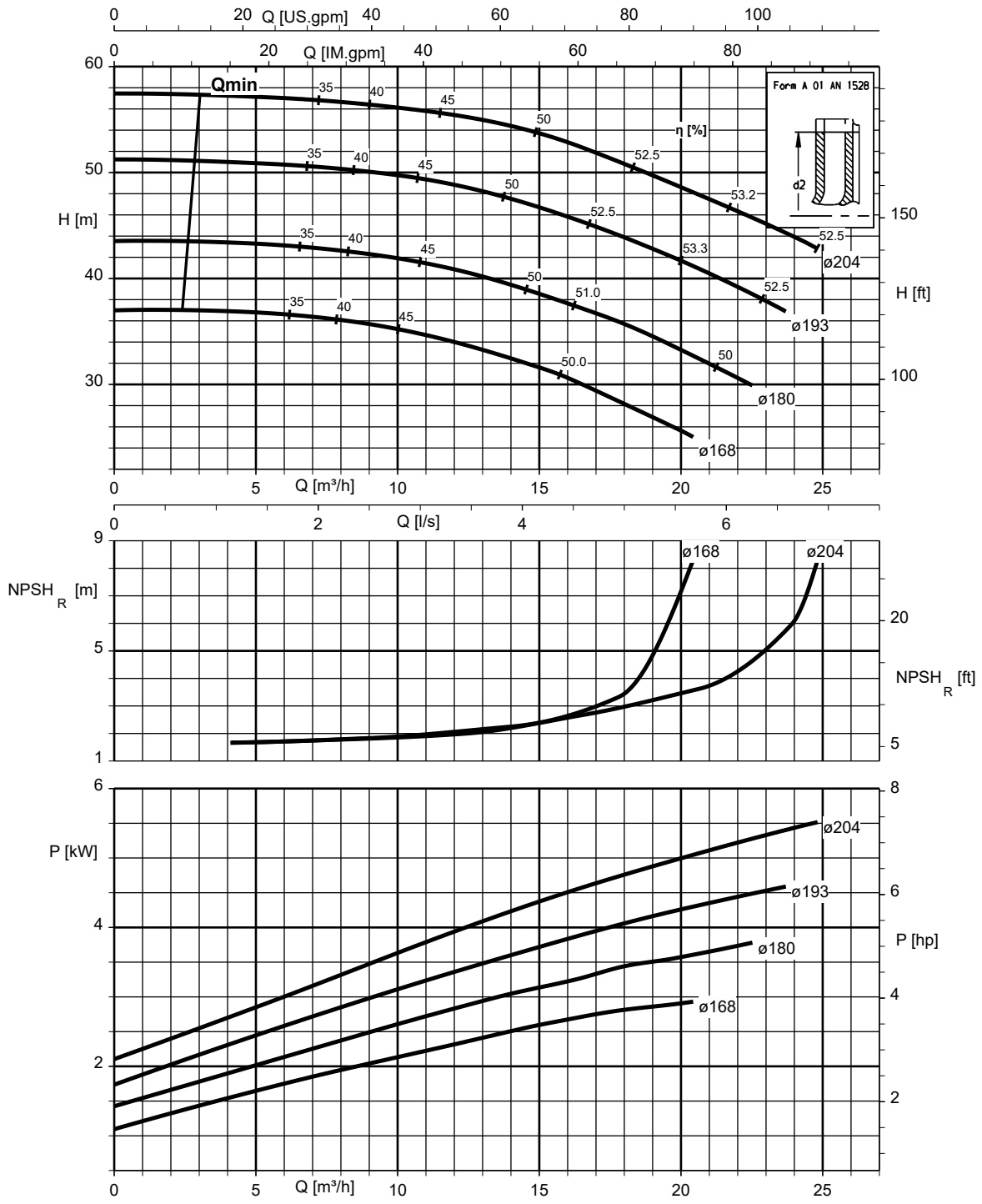

Vlet , Velta 050-032-250.1, n = 2900 rpm

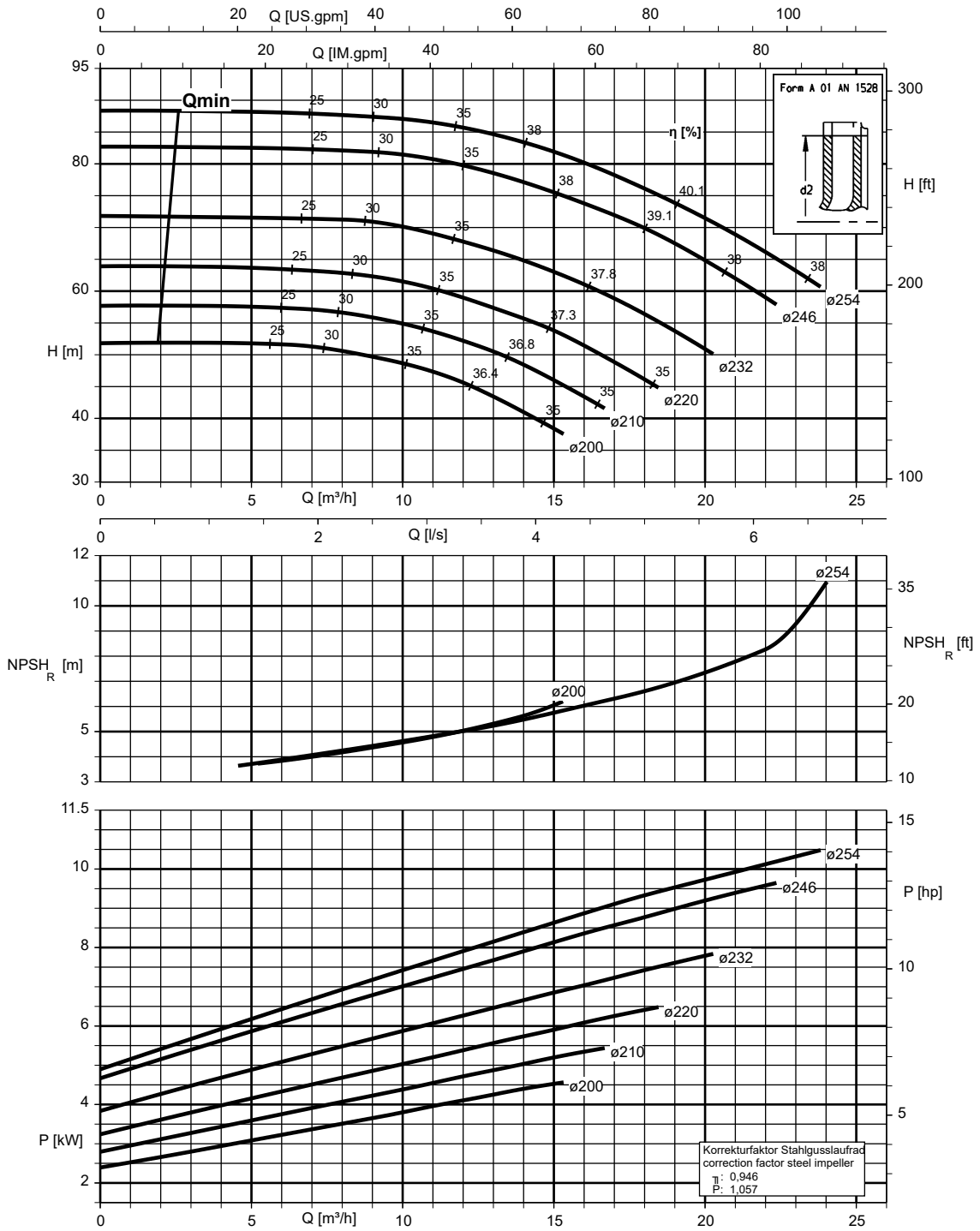

K1311.452/20/2

Vlet , Velta 050-032-125, n = 2900 rpm

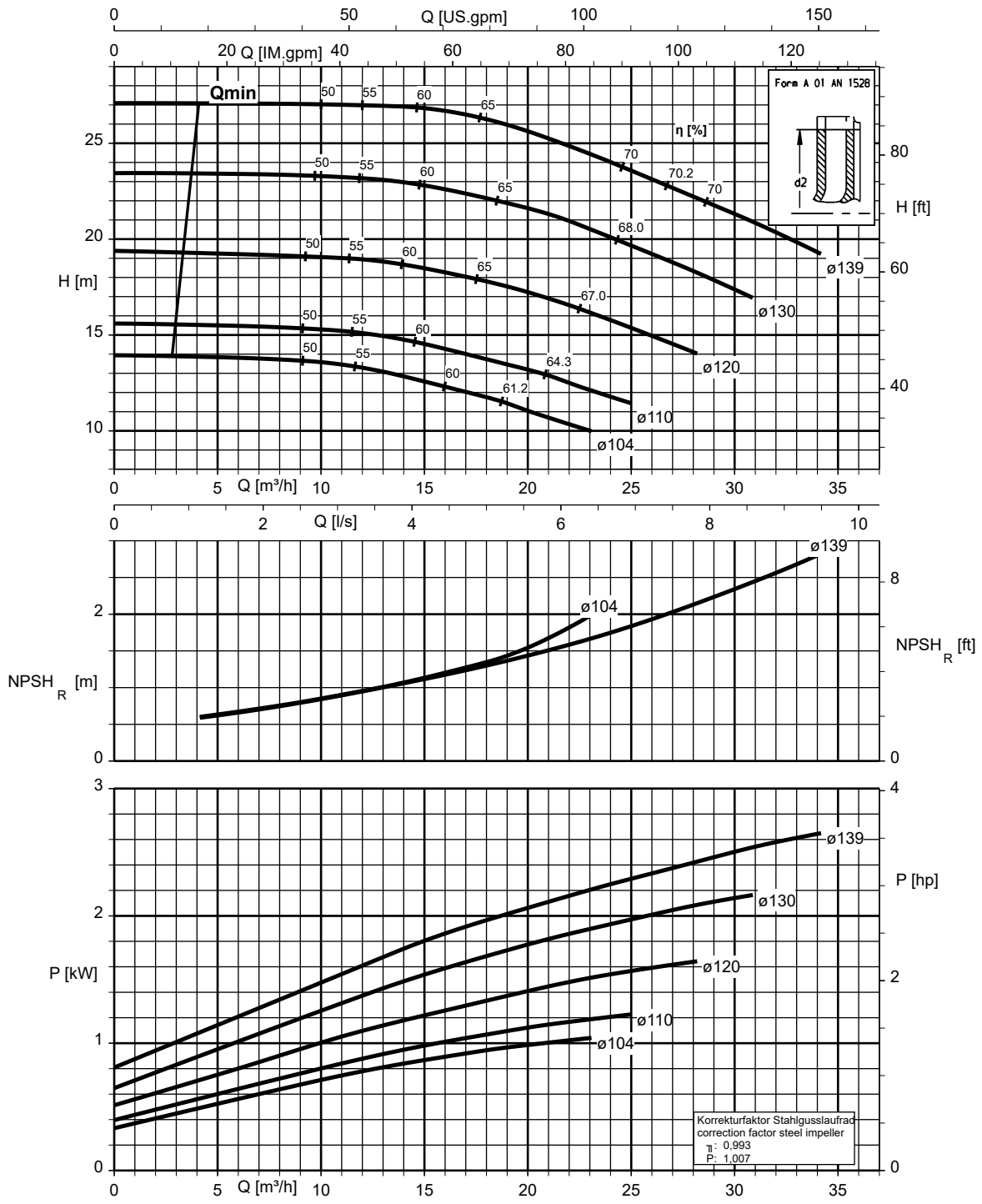

K1311.452/21/2

Vlet , Velta 050-032-160, n = 2900 rpm

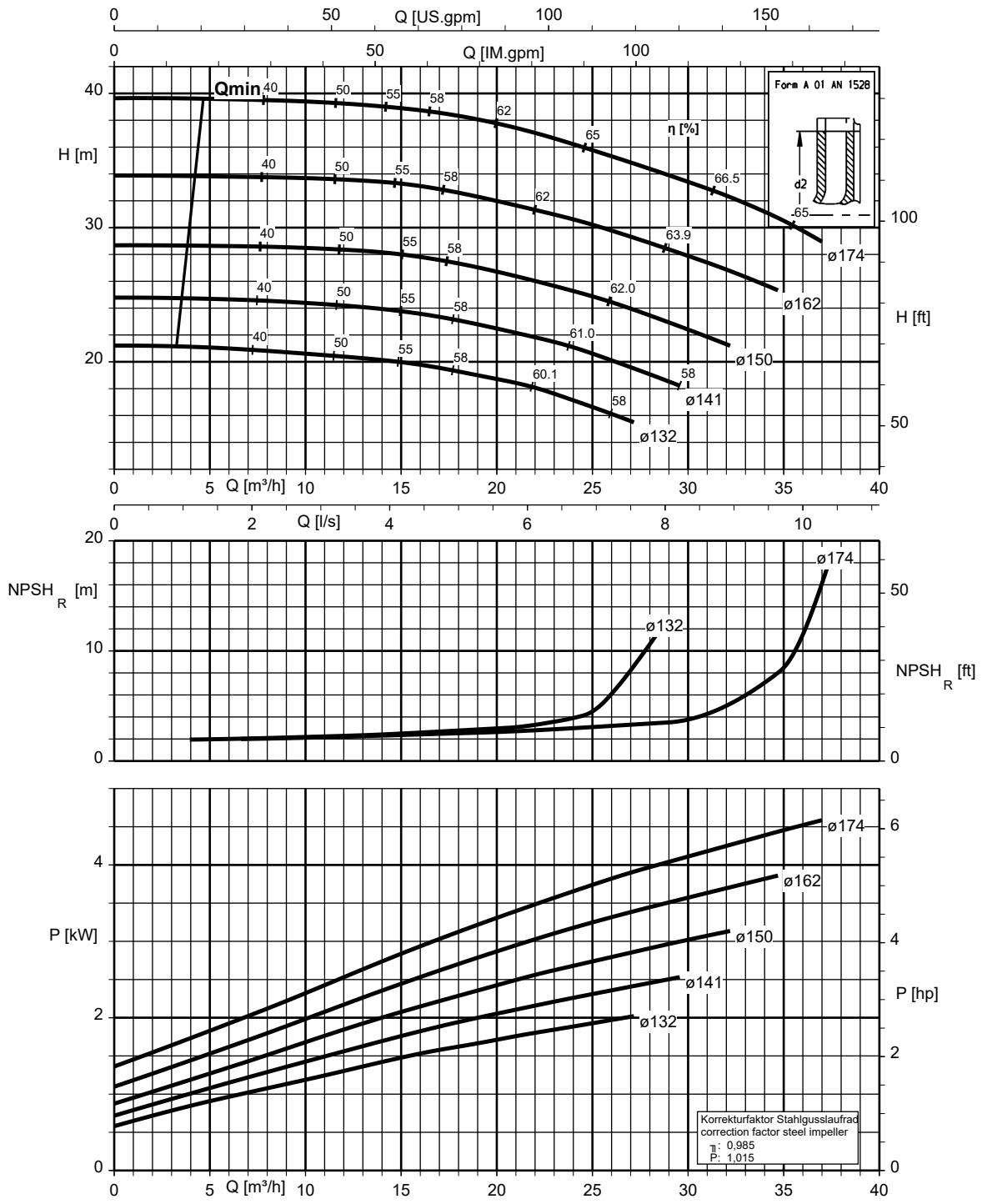

Vlet , Velta 050-032-200, n = 2900 rpm

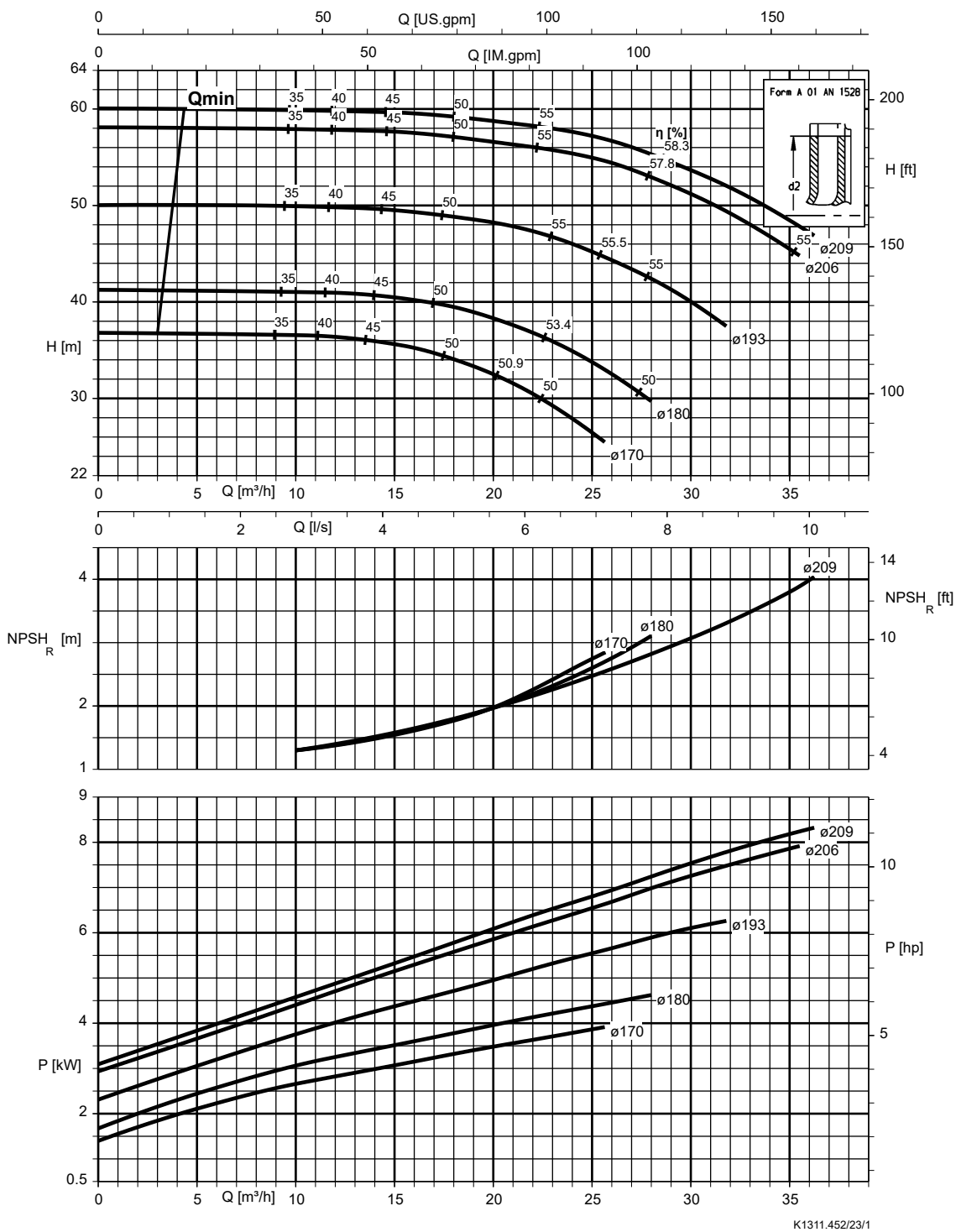

Vlet , Velta 050-032-250, n = 2900 rpm

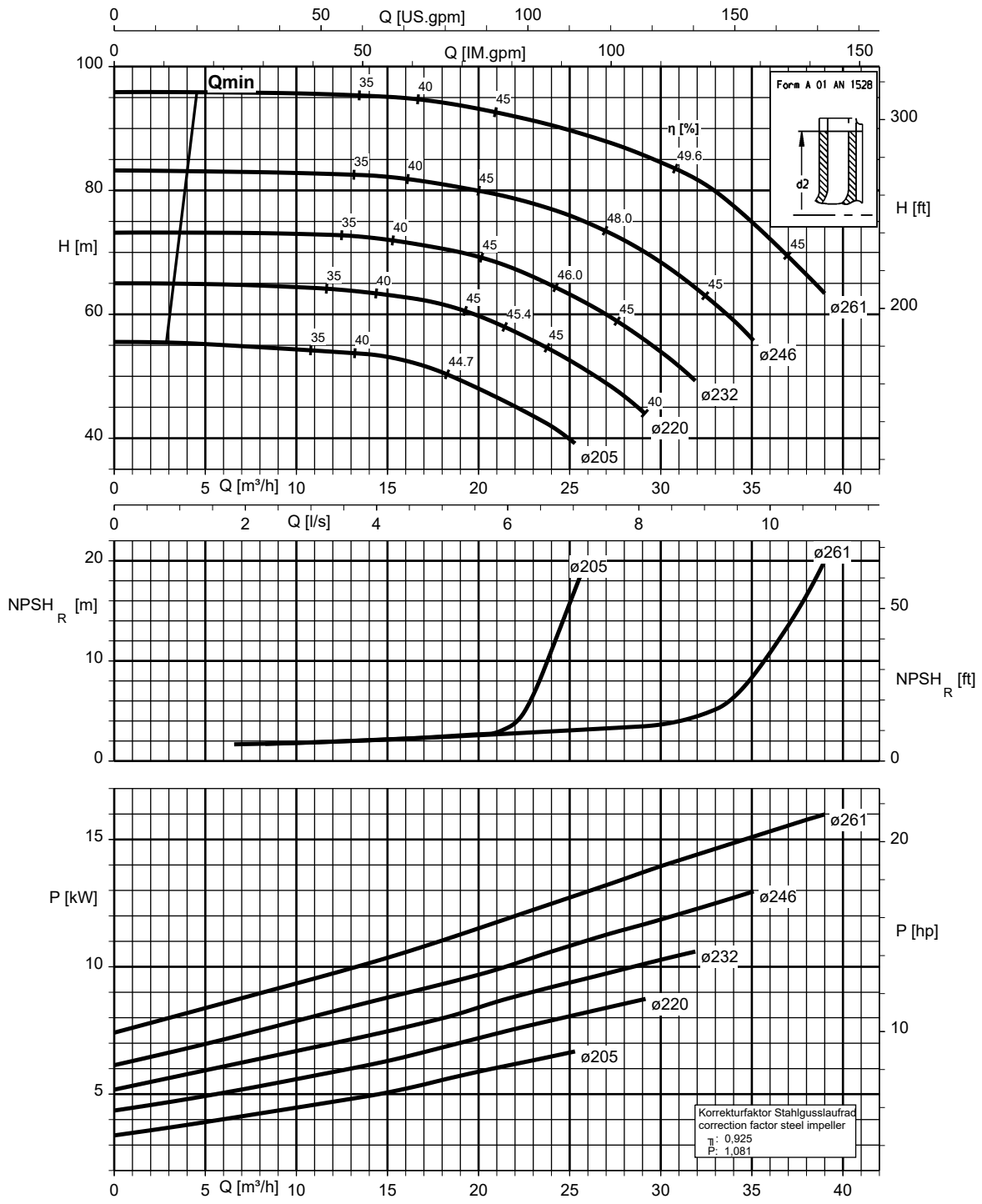



Vlet , Velta 065-040-125, n = 2900 rpm

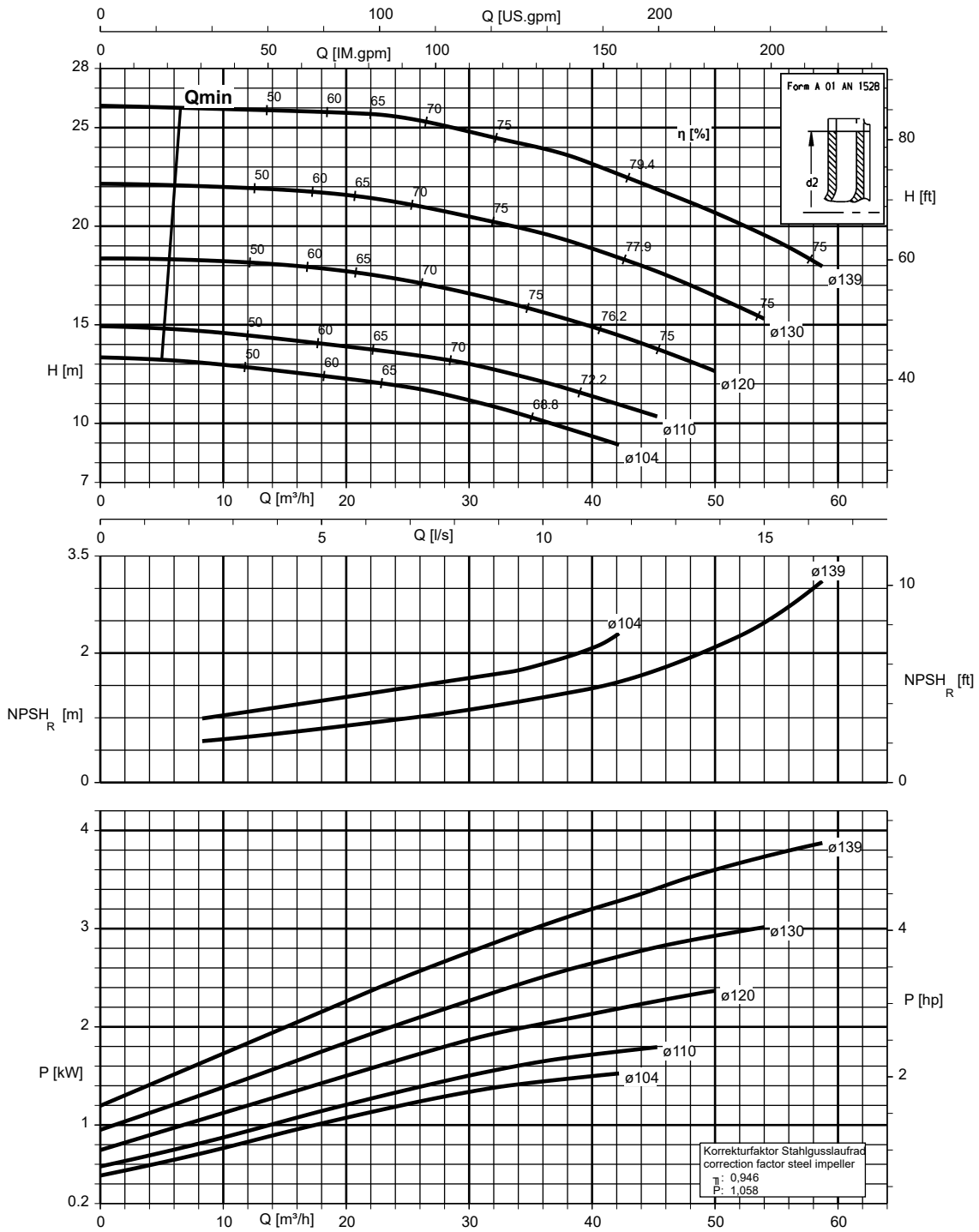

K1311.452/25/1

Vlet , Velta 065-040-160, n = 2900 rpm

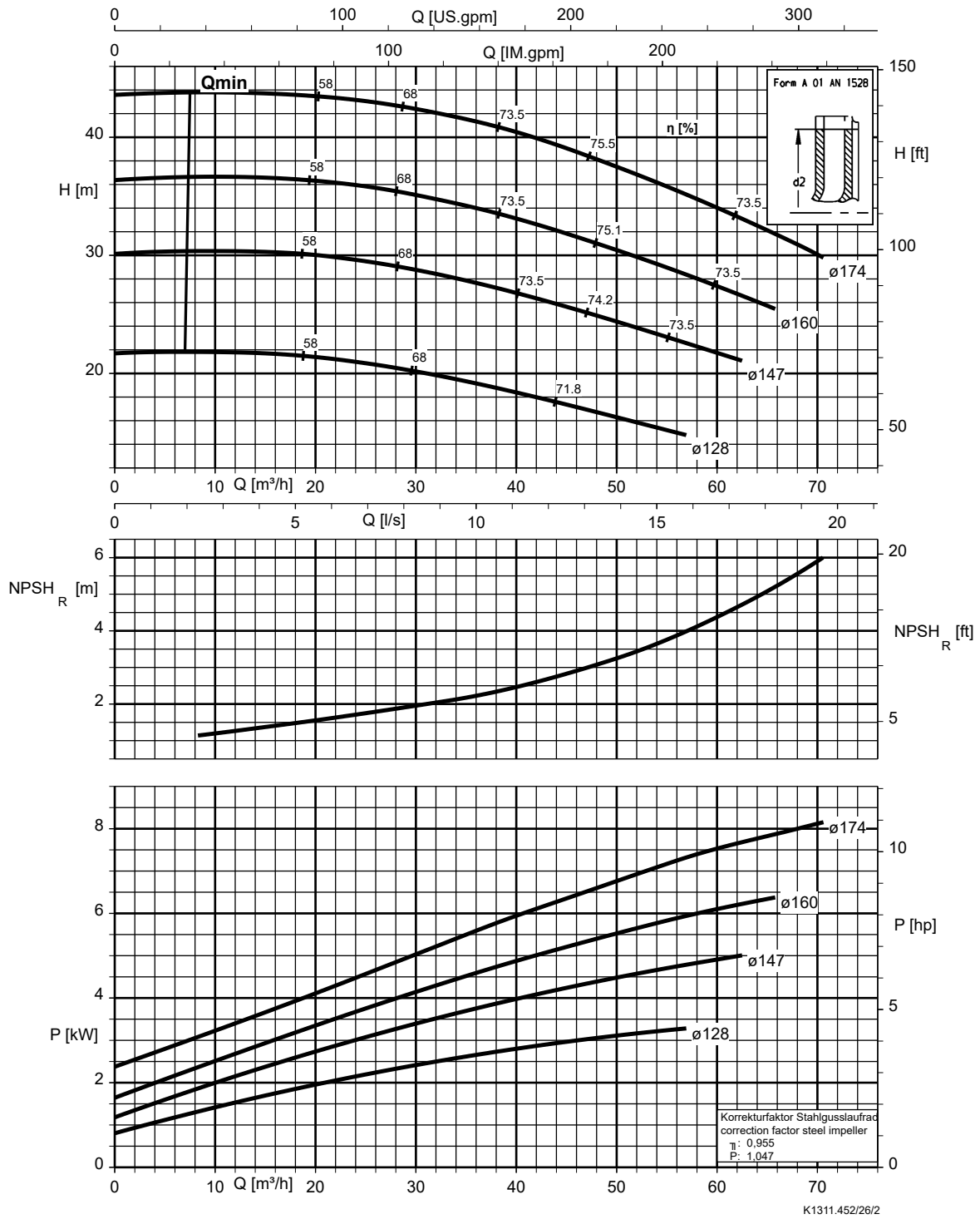

Vlet , Velta 065-040-200, n = 2900 rpm

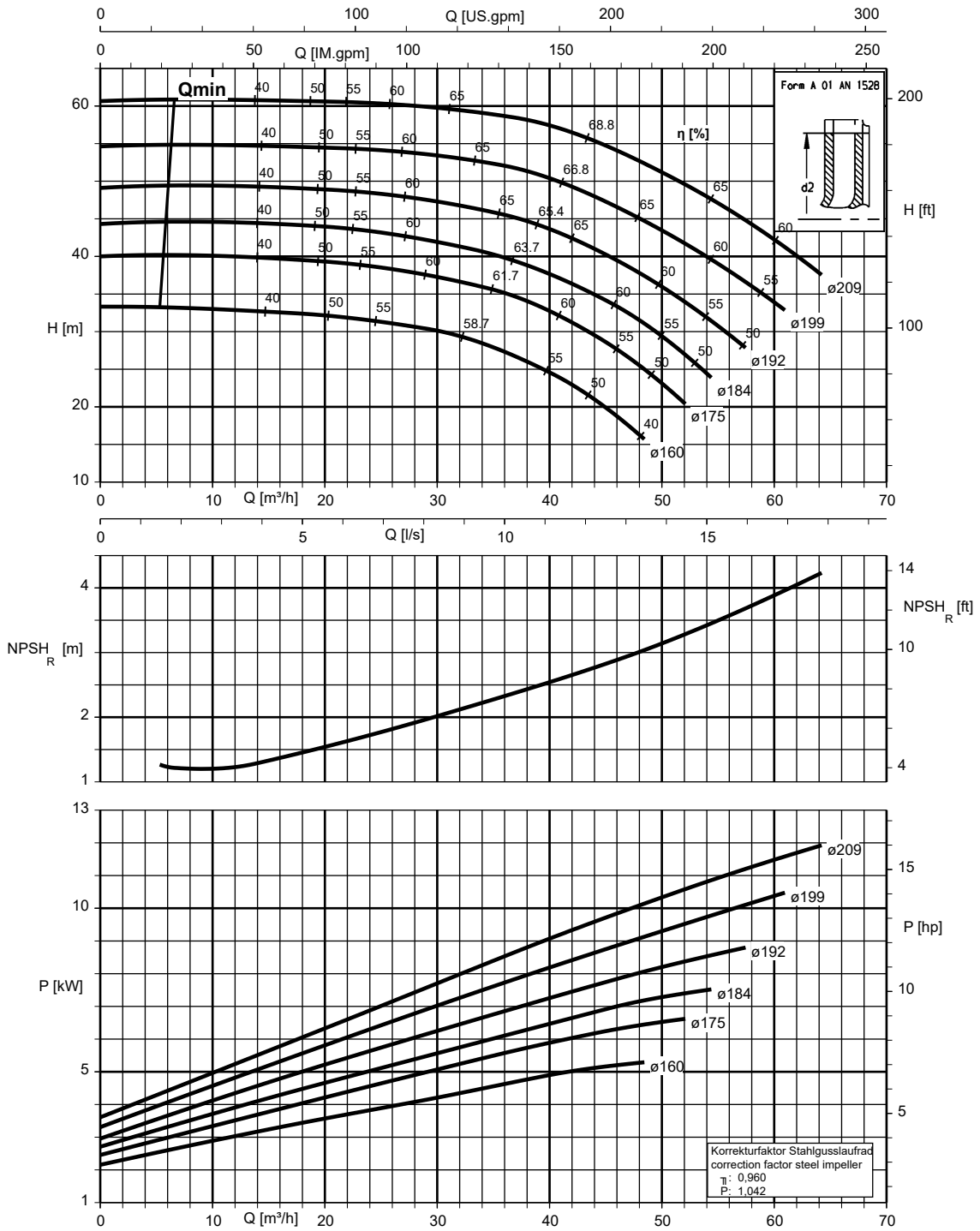

Vlet , Velta 065-040-250, n = 2900 rpm

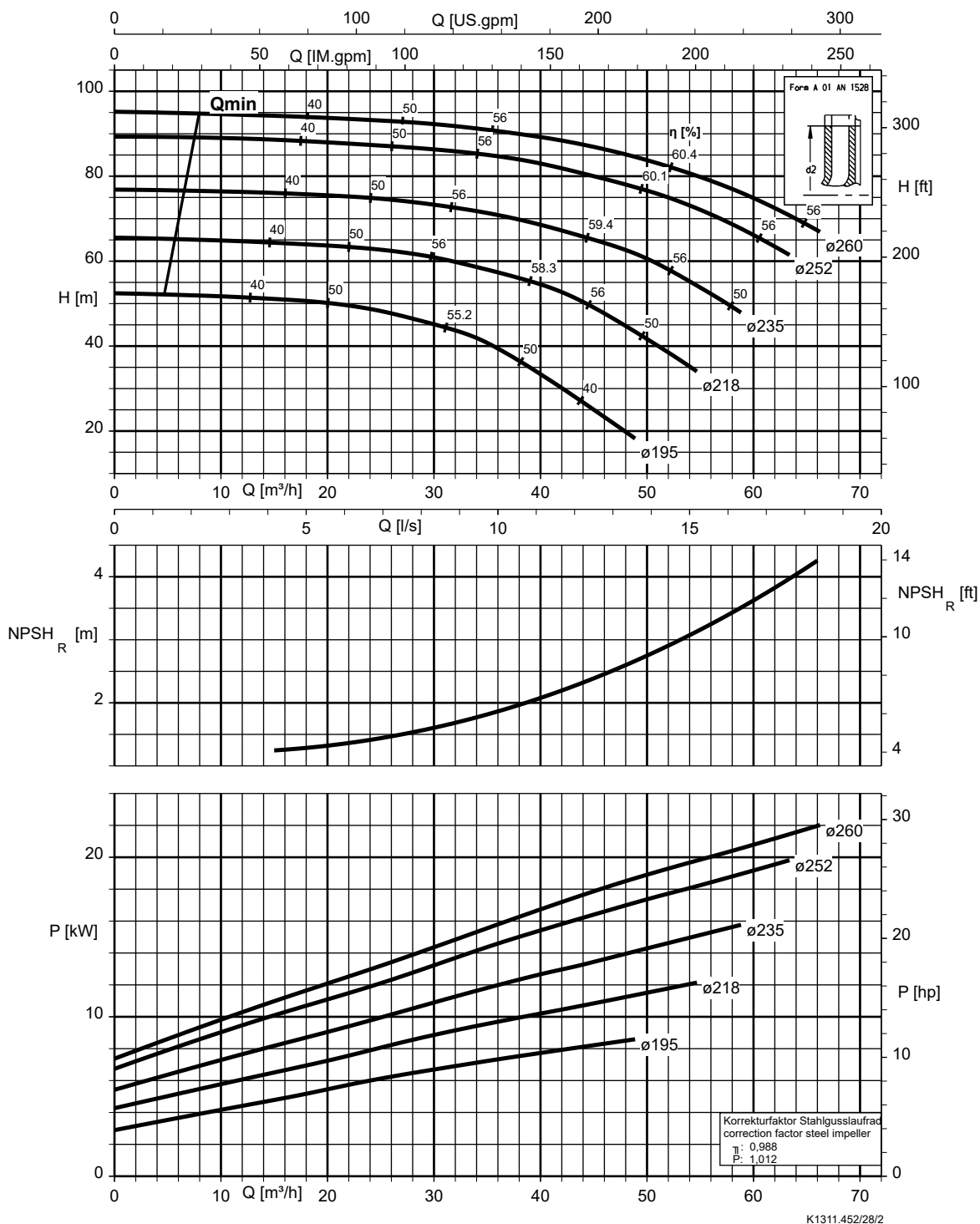

Vlet , Velta 065-040-315, n = 2900 rpm

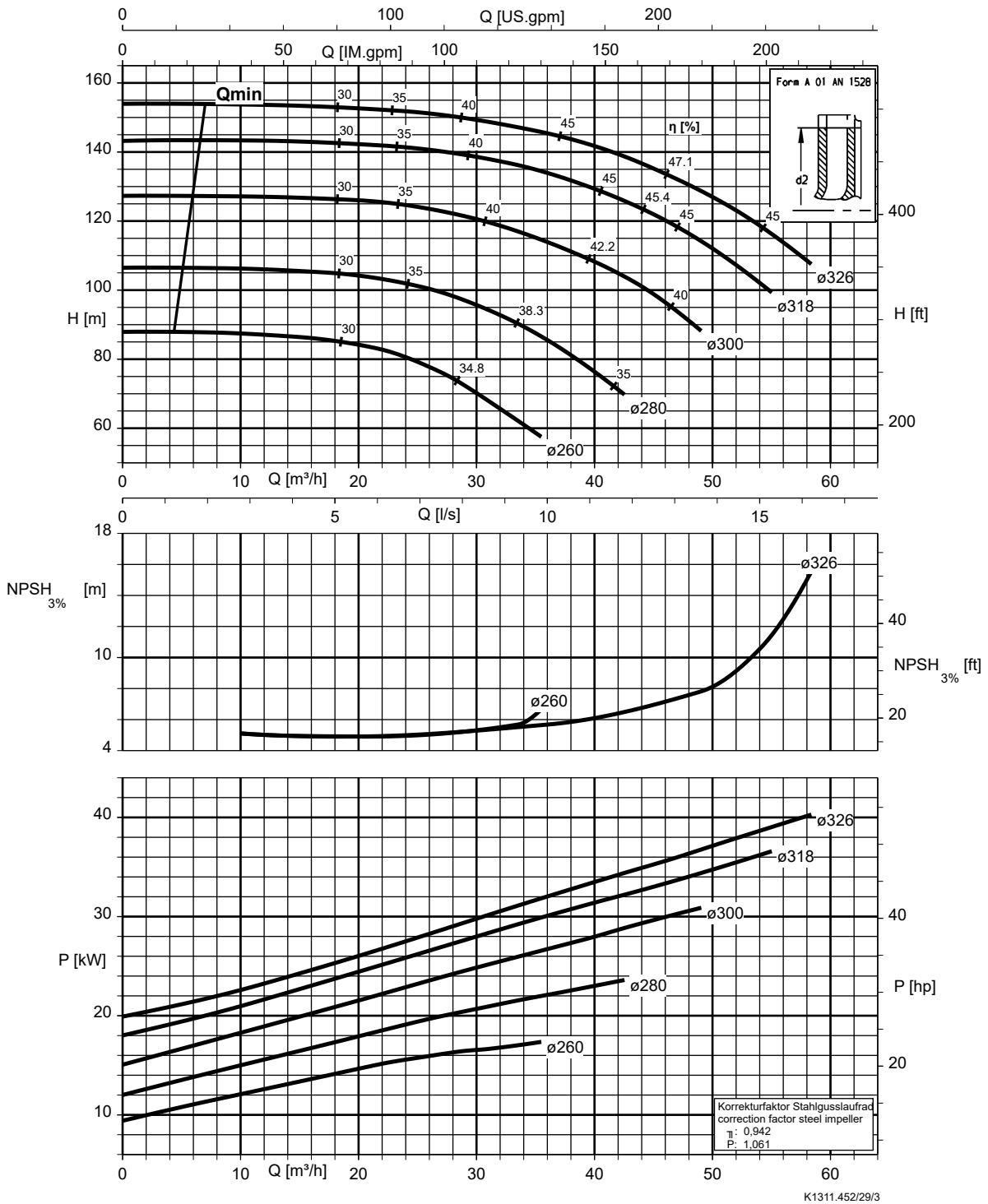

Vlet , Velta 065-050-125, n = 2900 rpm

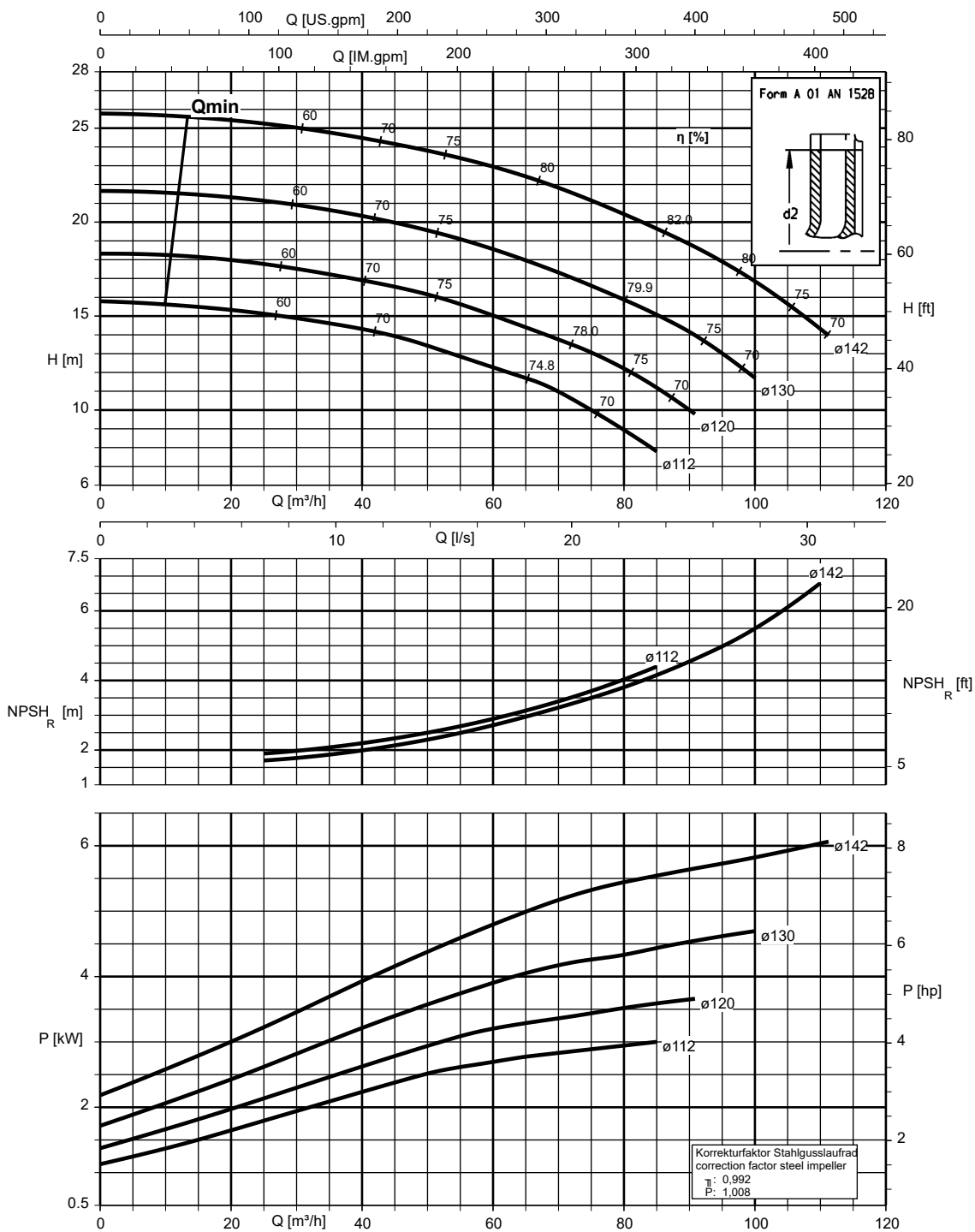

K1311.452/30/1

Vlet , Velta 065-050-160, n = 2900 rpm

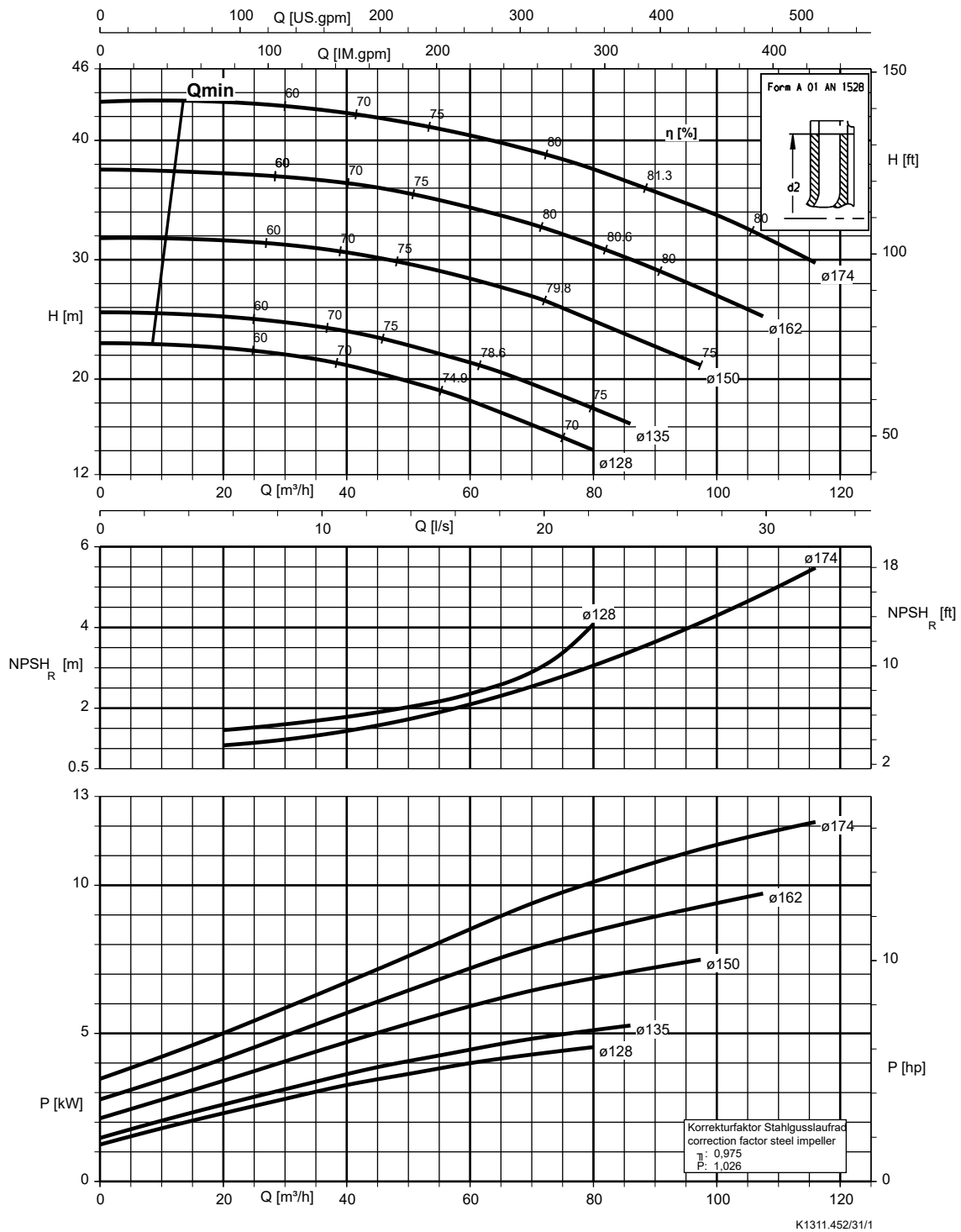

Vlet , Velta 065-050-200, n = 2900 rpm

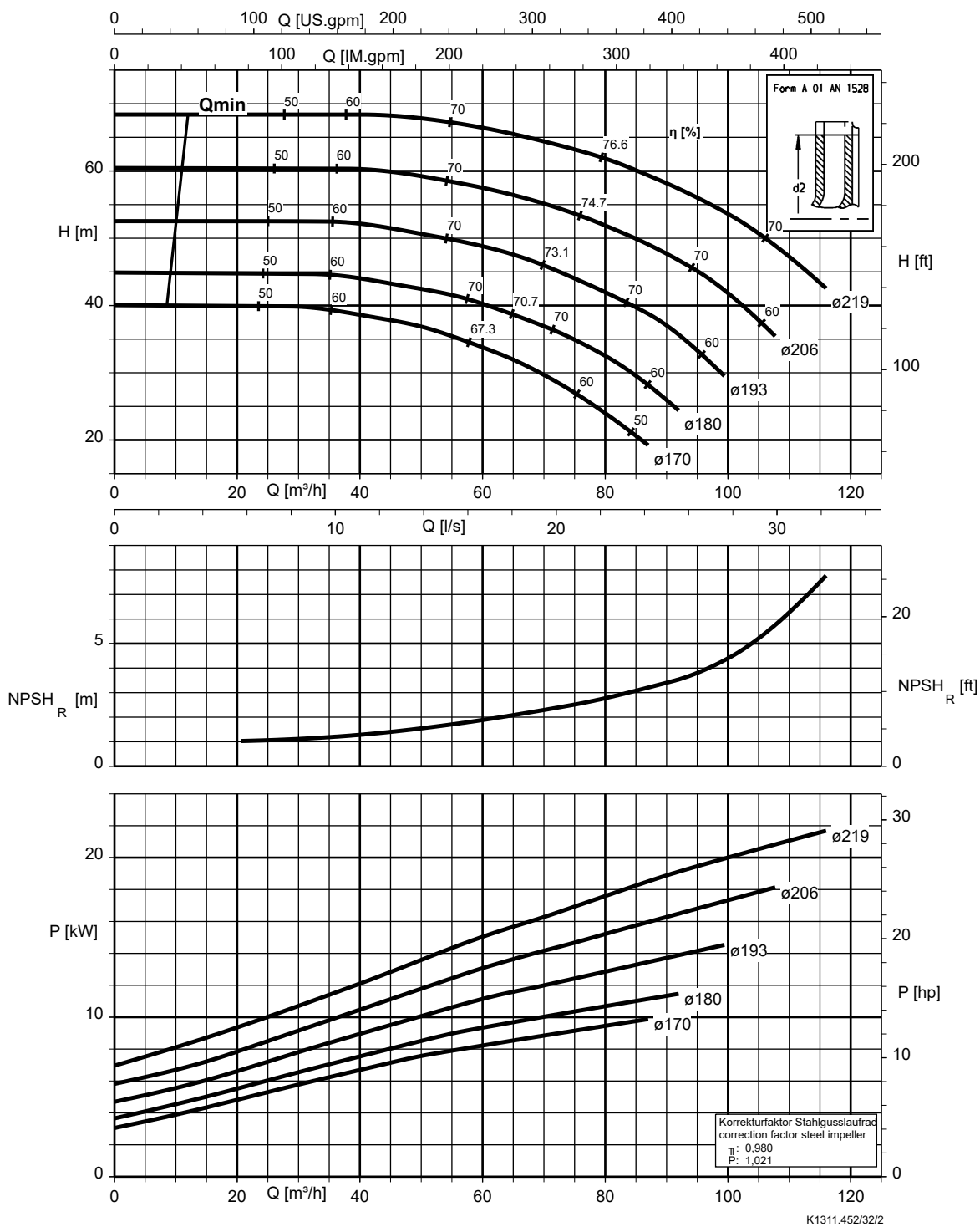



Vlet , Velta 065-050-250, n = 2900 rpm

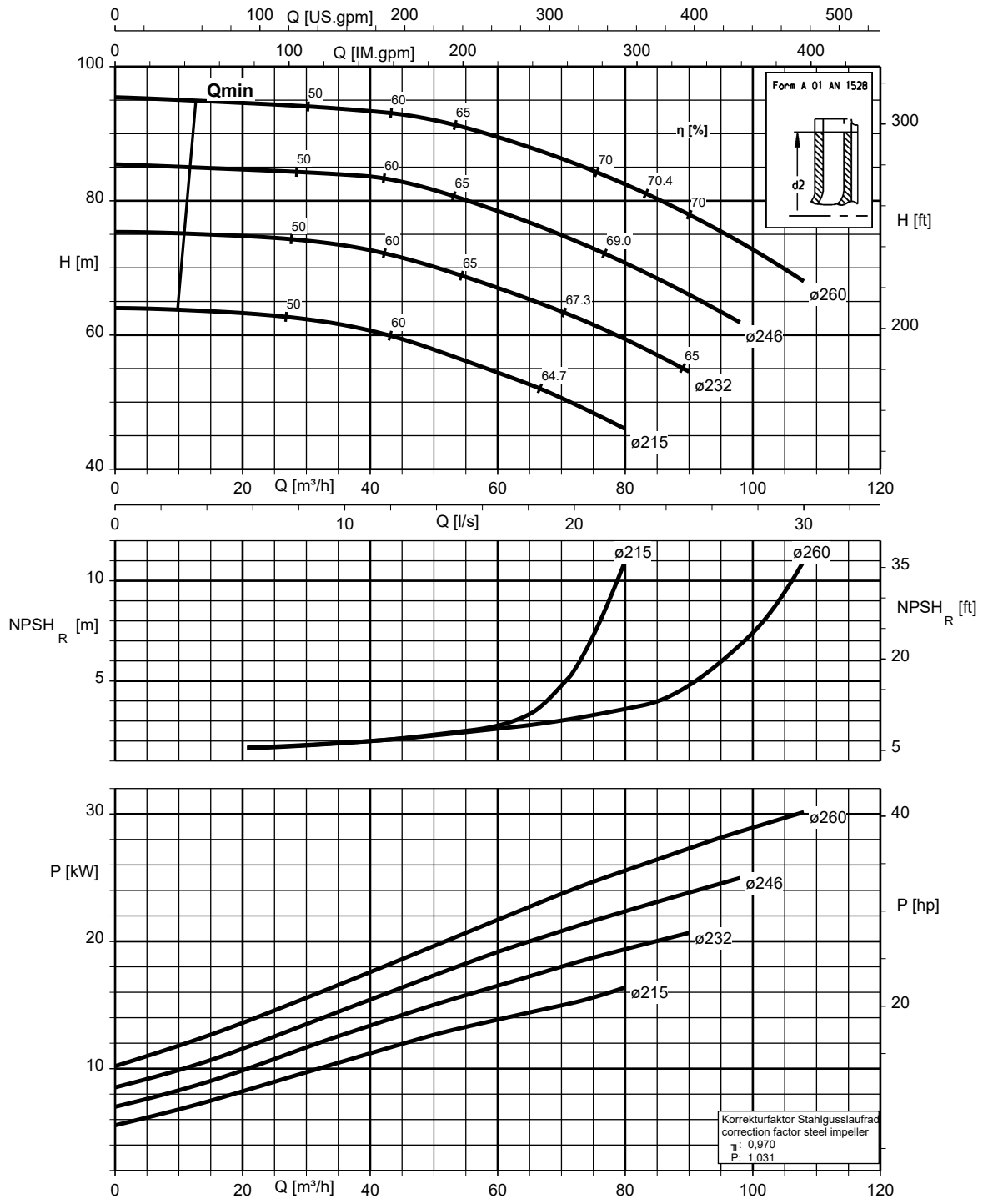

Vlet , Velta 065-050-315, n = 2900 rpm

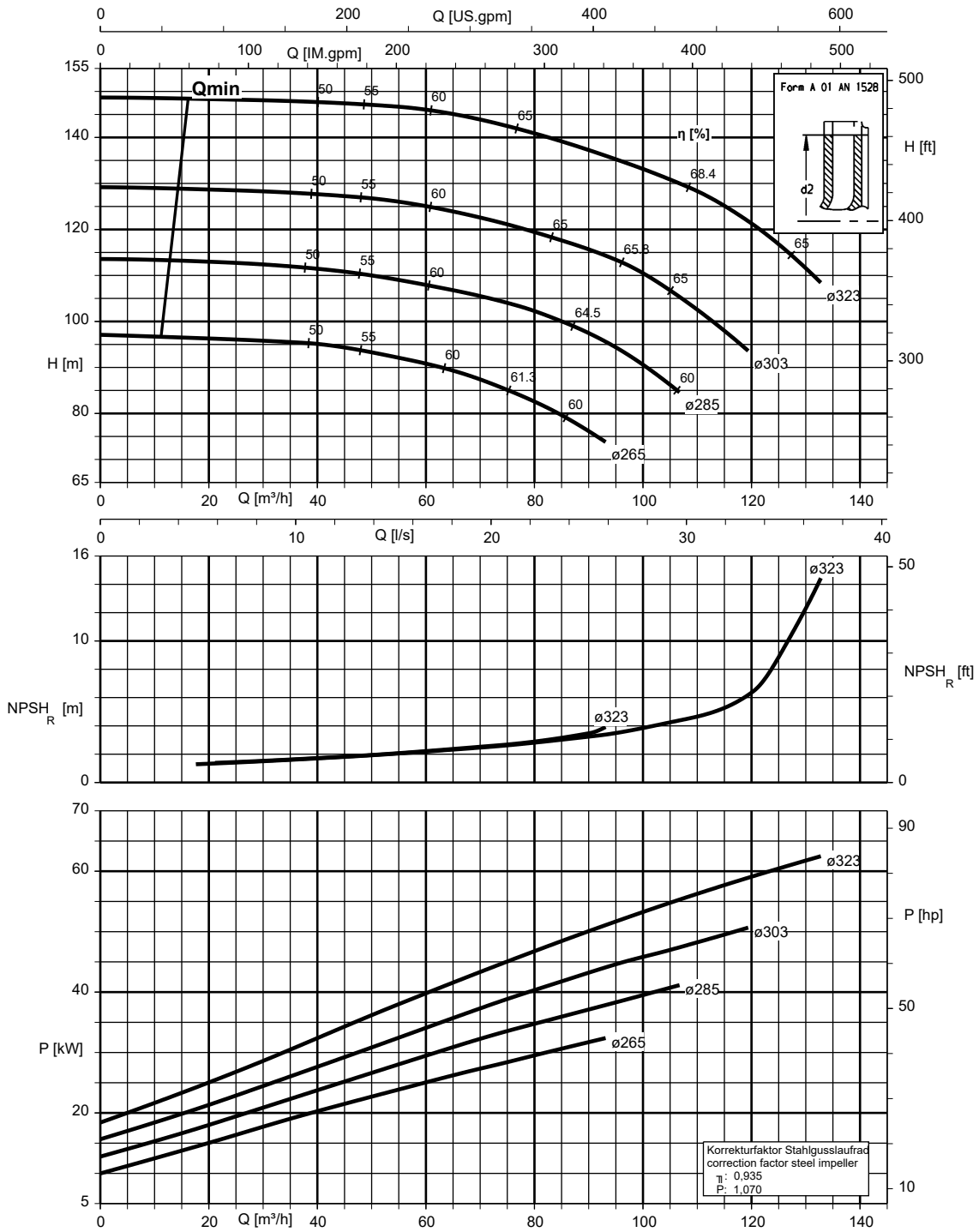

K1311.452/34/2

Vlet , Velta 080-065-125, n = 2900 rpm

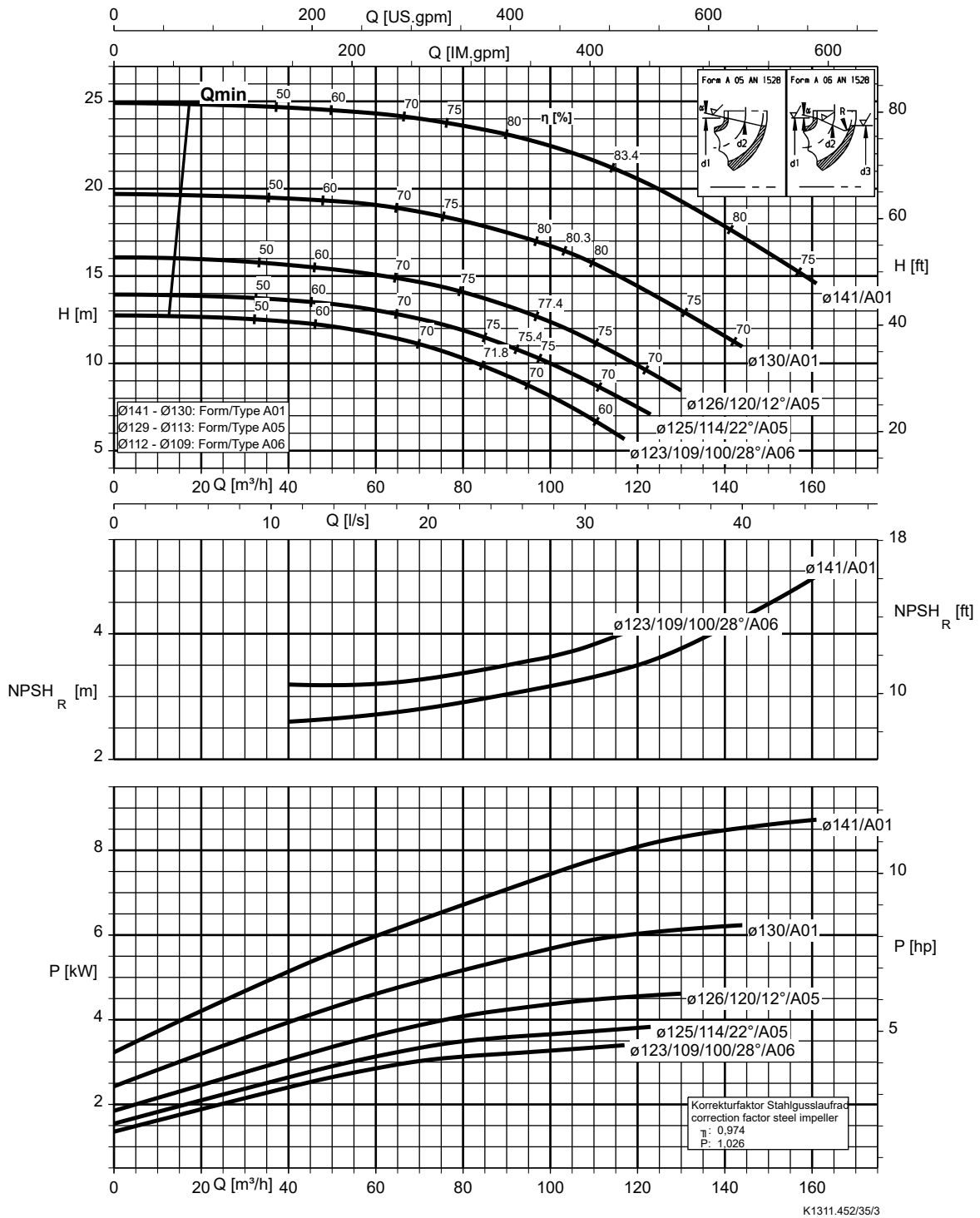

Vlet , Velta 080-065-160, n = 2900 rpm

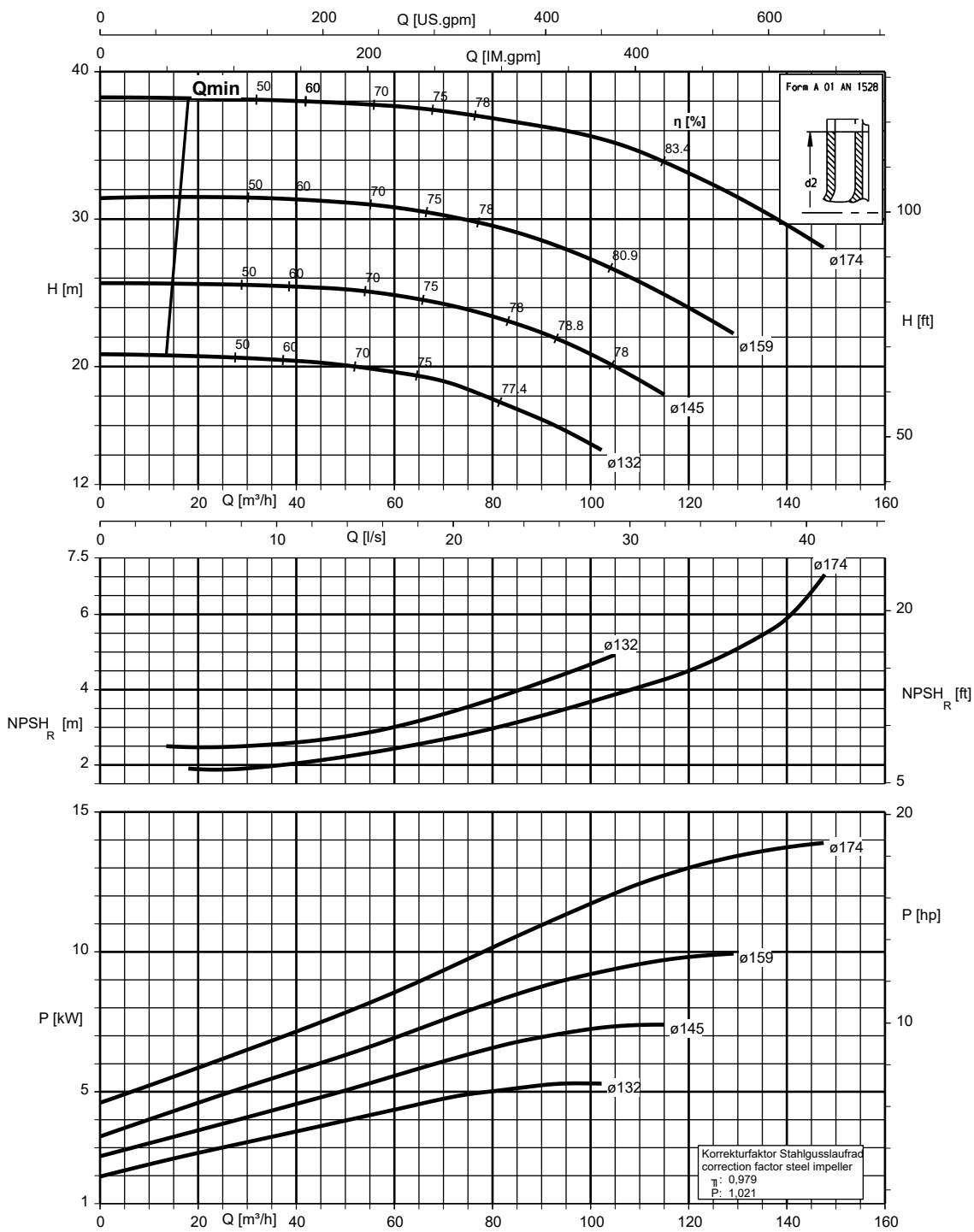

K1311.452/36/2

Vlet , Velta 080-065-200, n = 2900 rpm

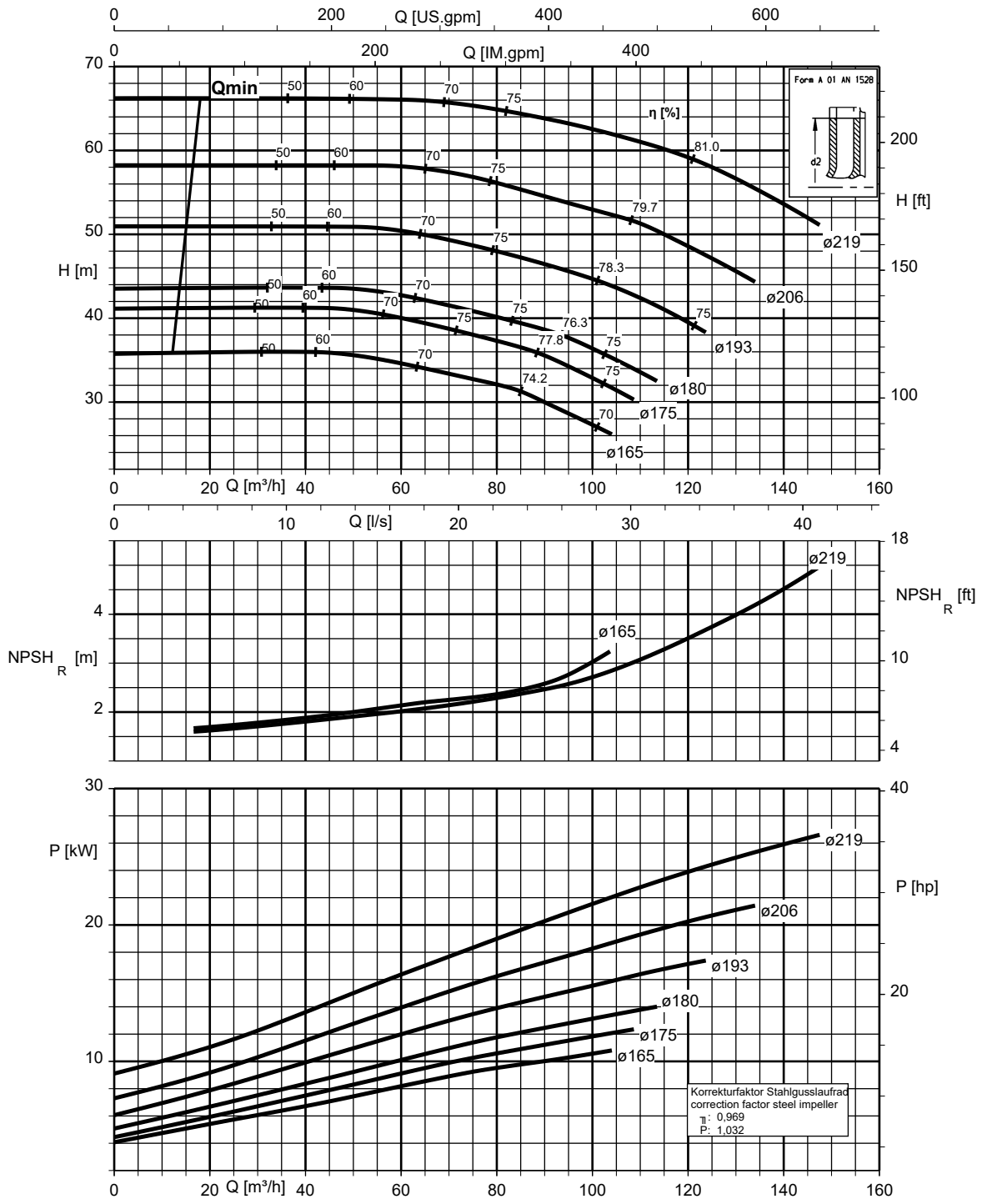

K1311.452/37/2

Vlet , Velta 080-065-250, n = 2900 rpm

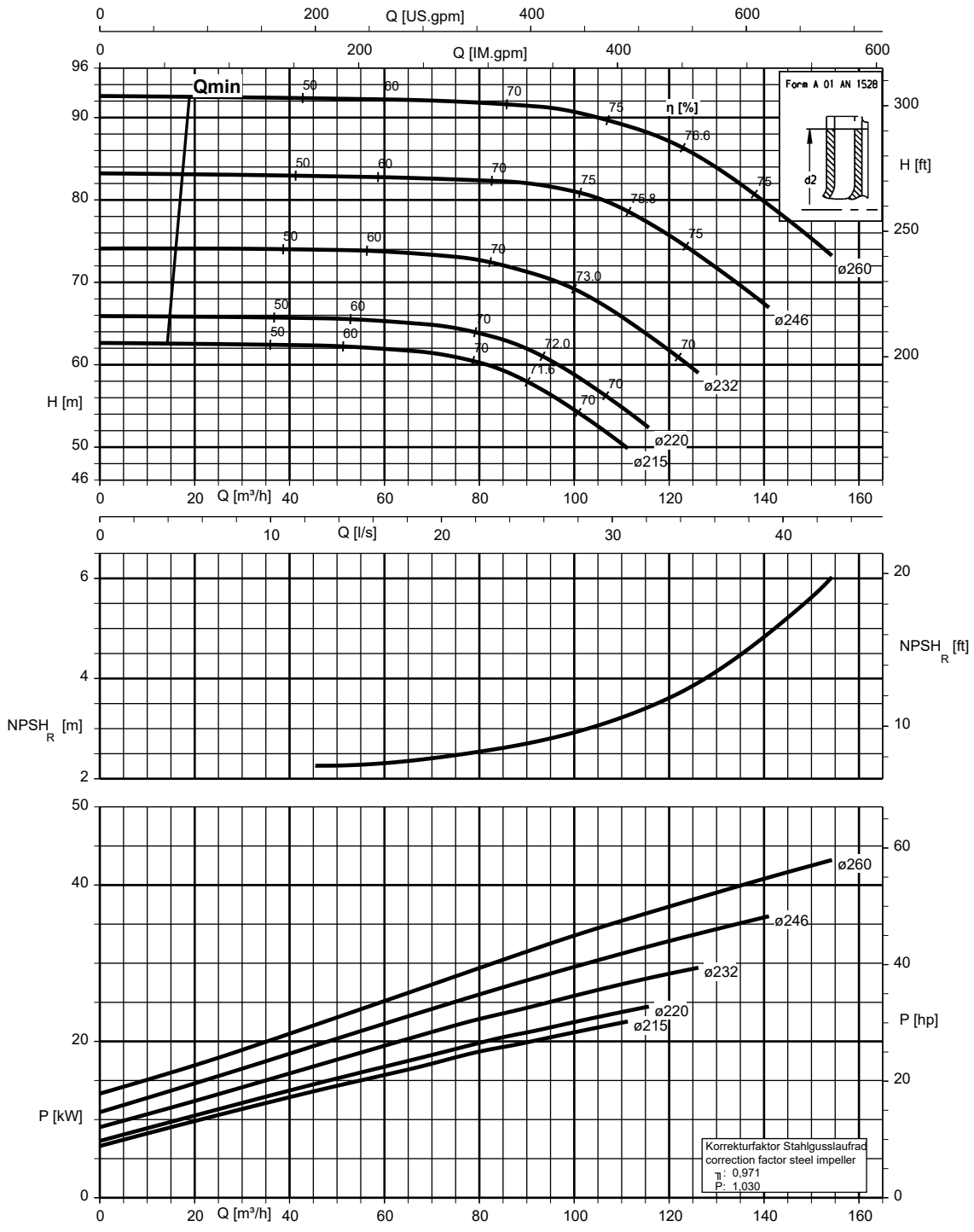

Vlet , Velta 080-065-315, n = 2900 rpm

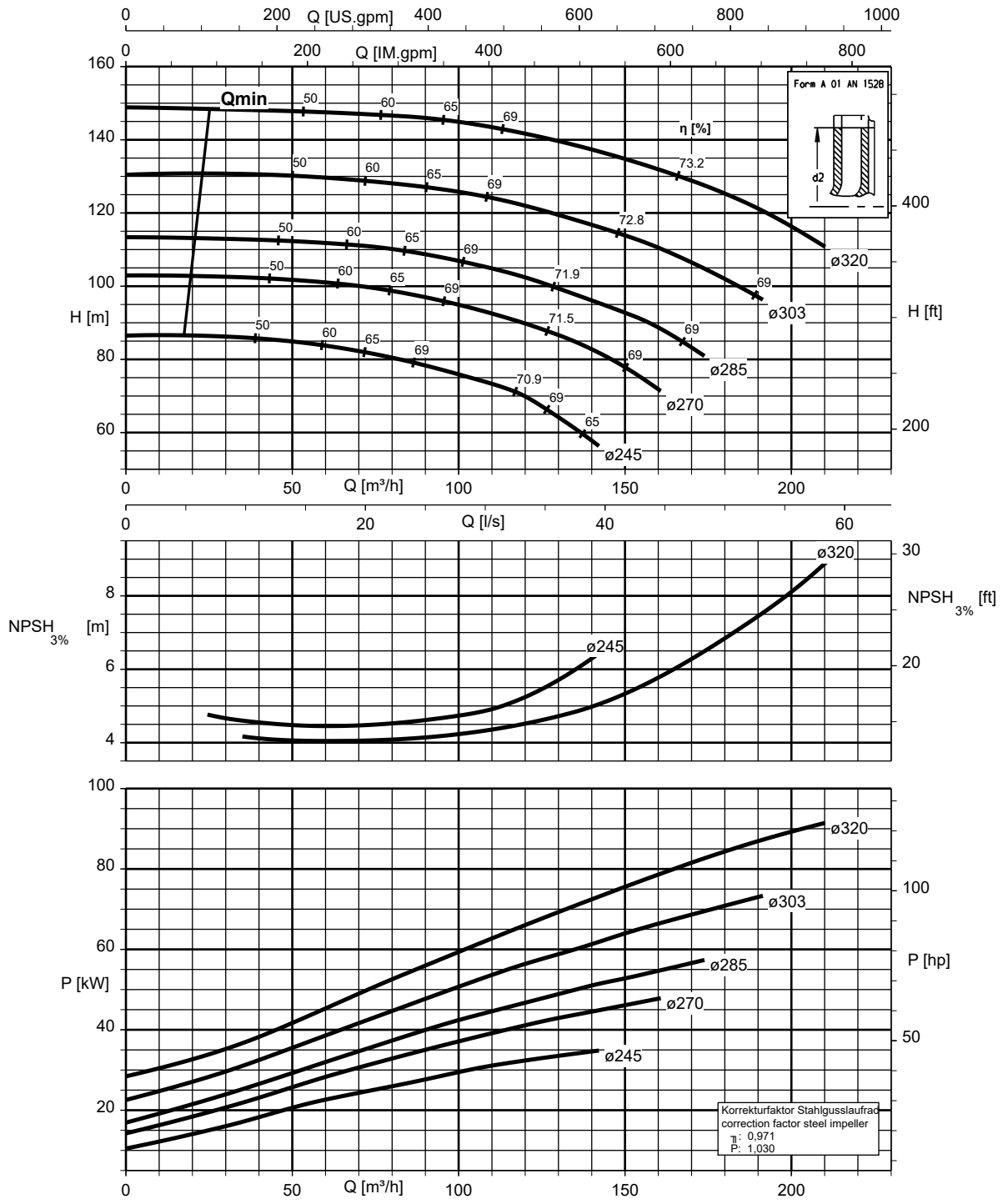

Vlet , Velta 100-080-160, n = 2900 rpm

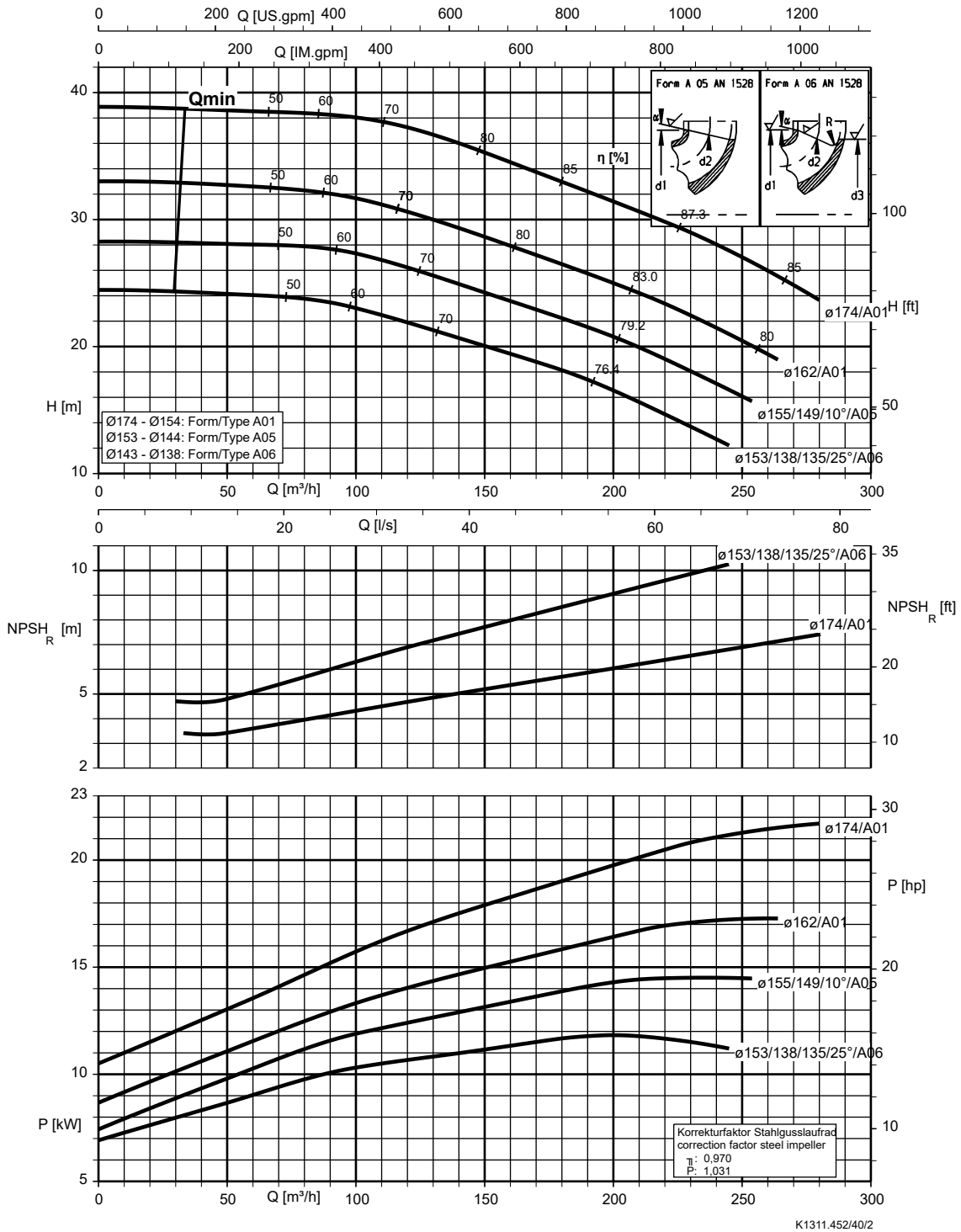



Vlet , Velta 100-080-200, n = 2900 rpm

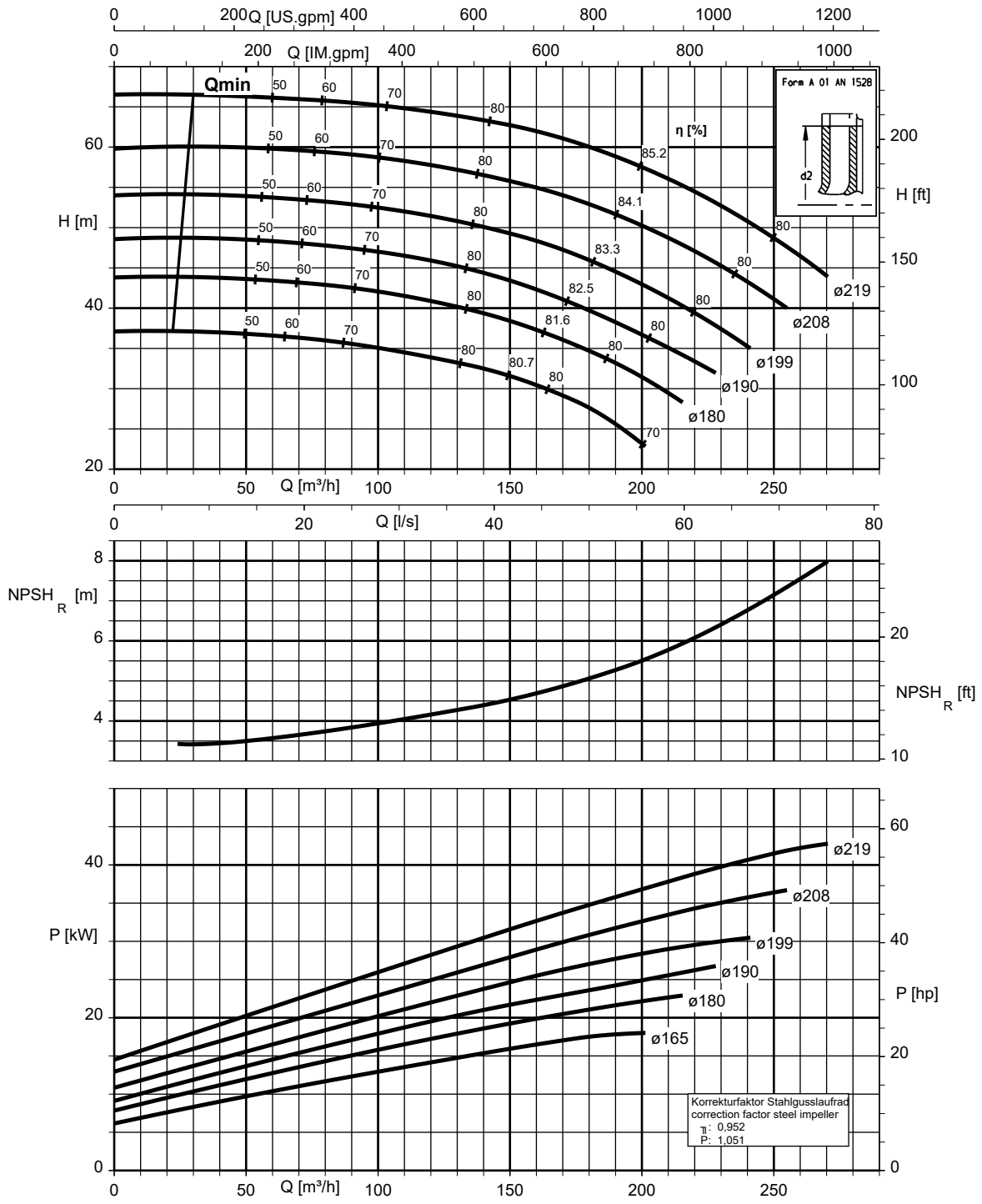

Vlet , Velta 100-080-250, n = 2900 rpm

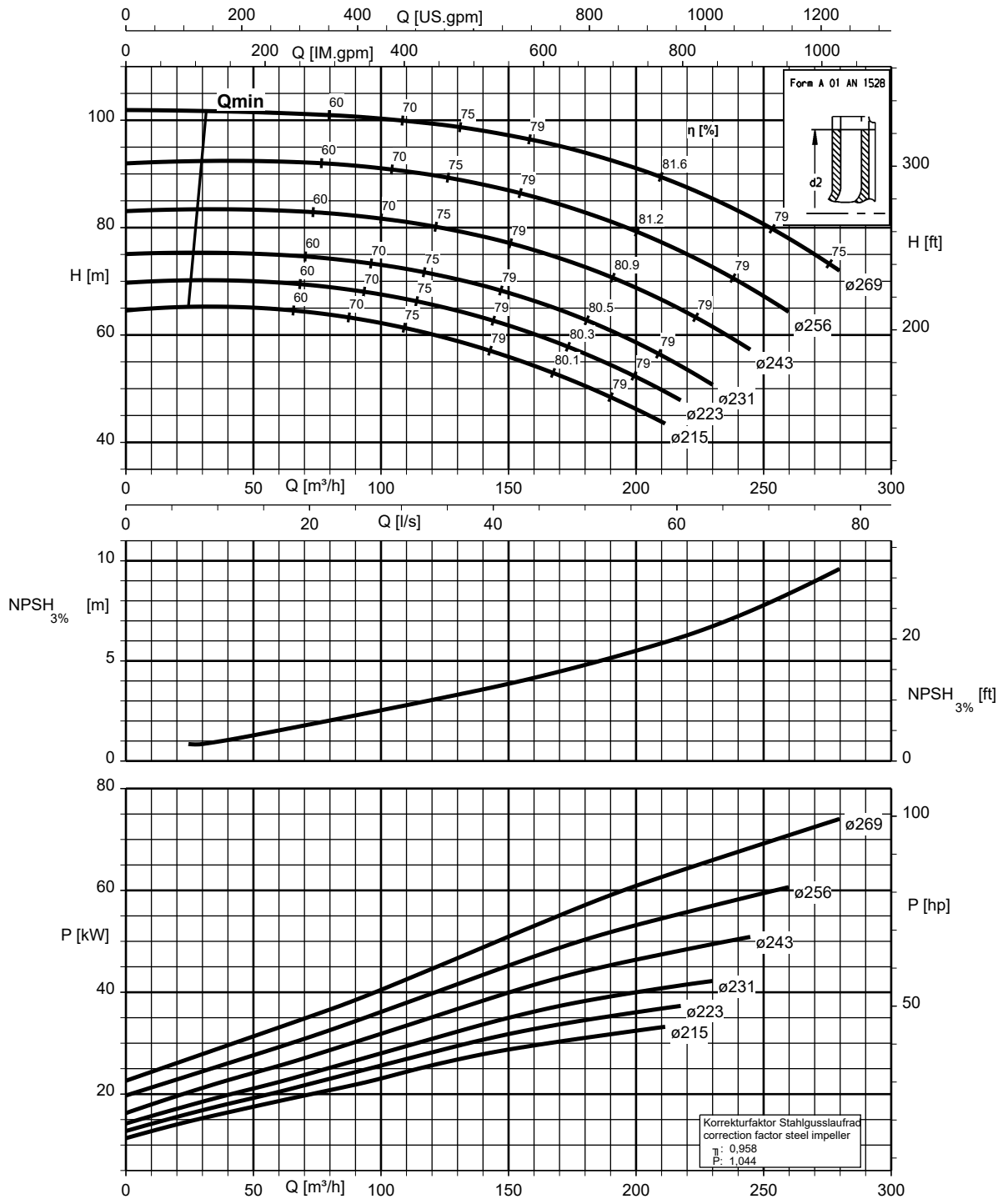

Vlet, Velta 100-080-315, n = 2900 rpm

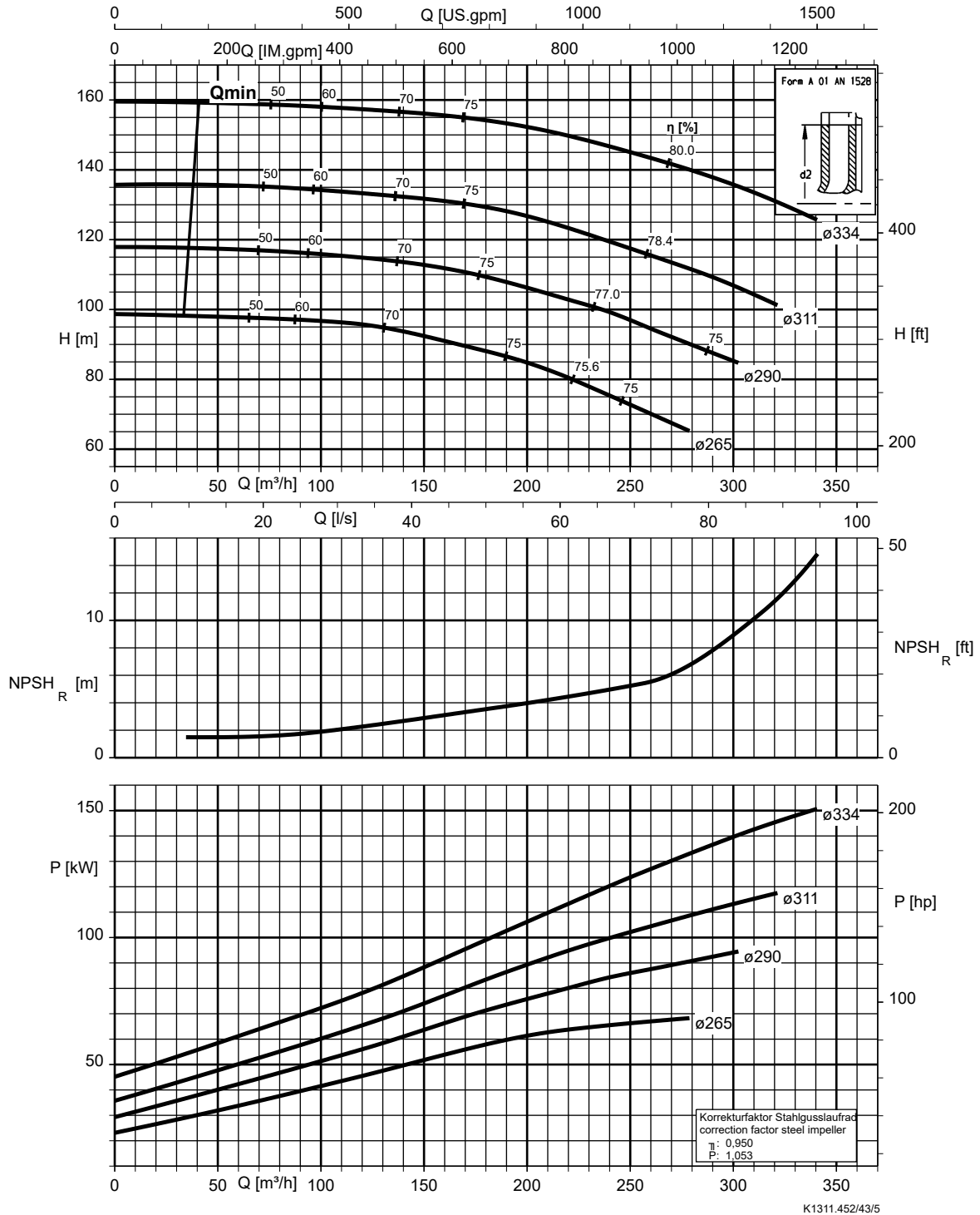

Vlet , Velta 125-100-160, n = 2900 rpm

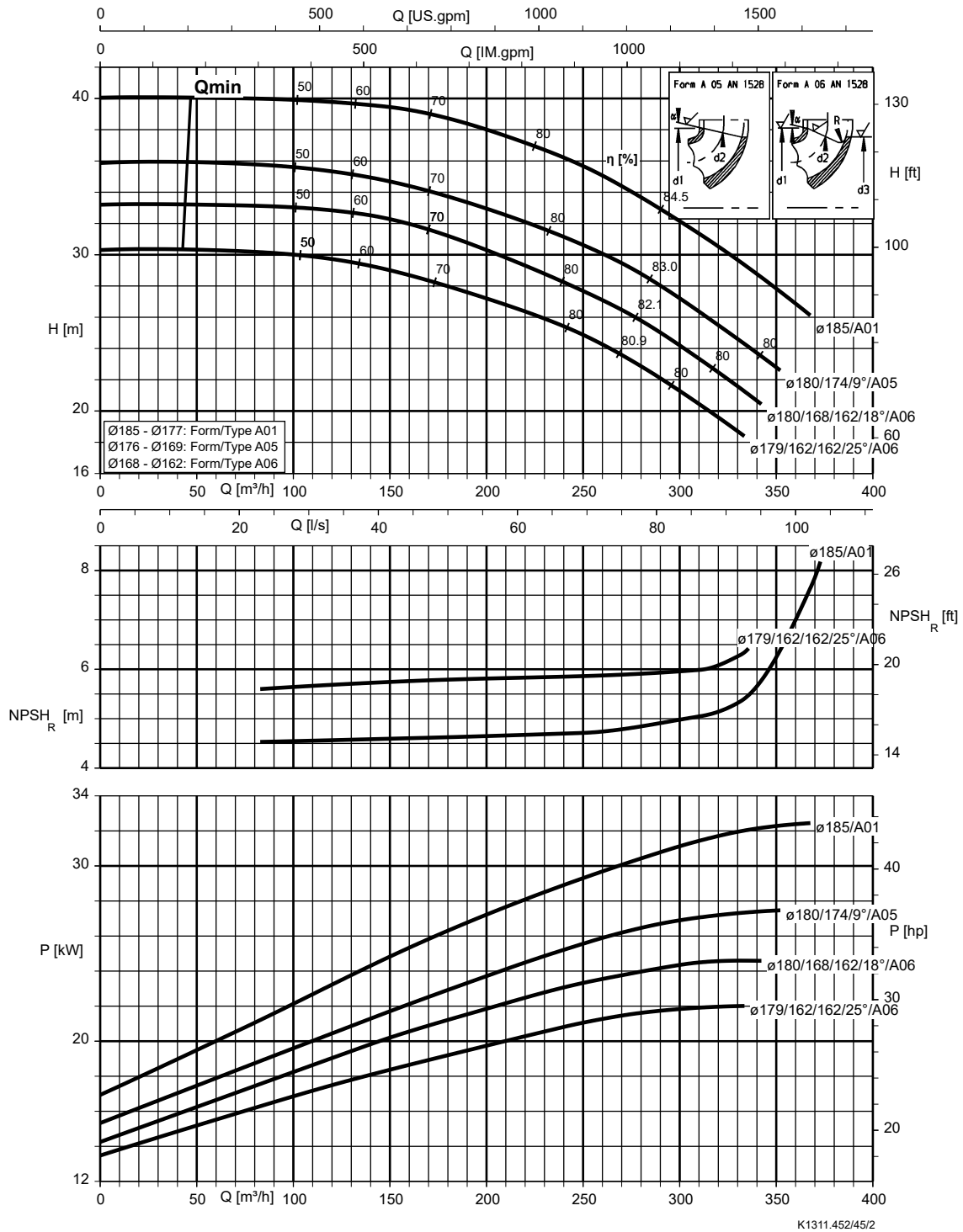

Vlet , Velta 125-100-200, n = 2900 rpm

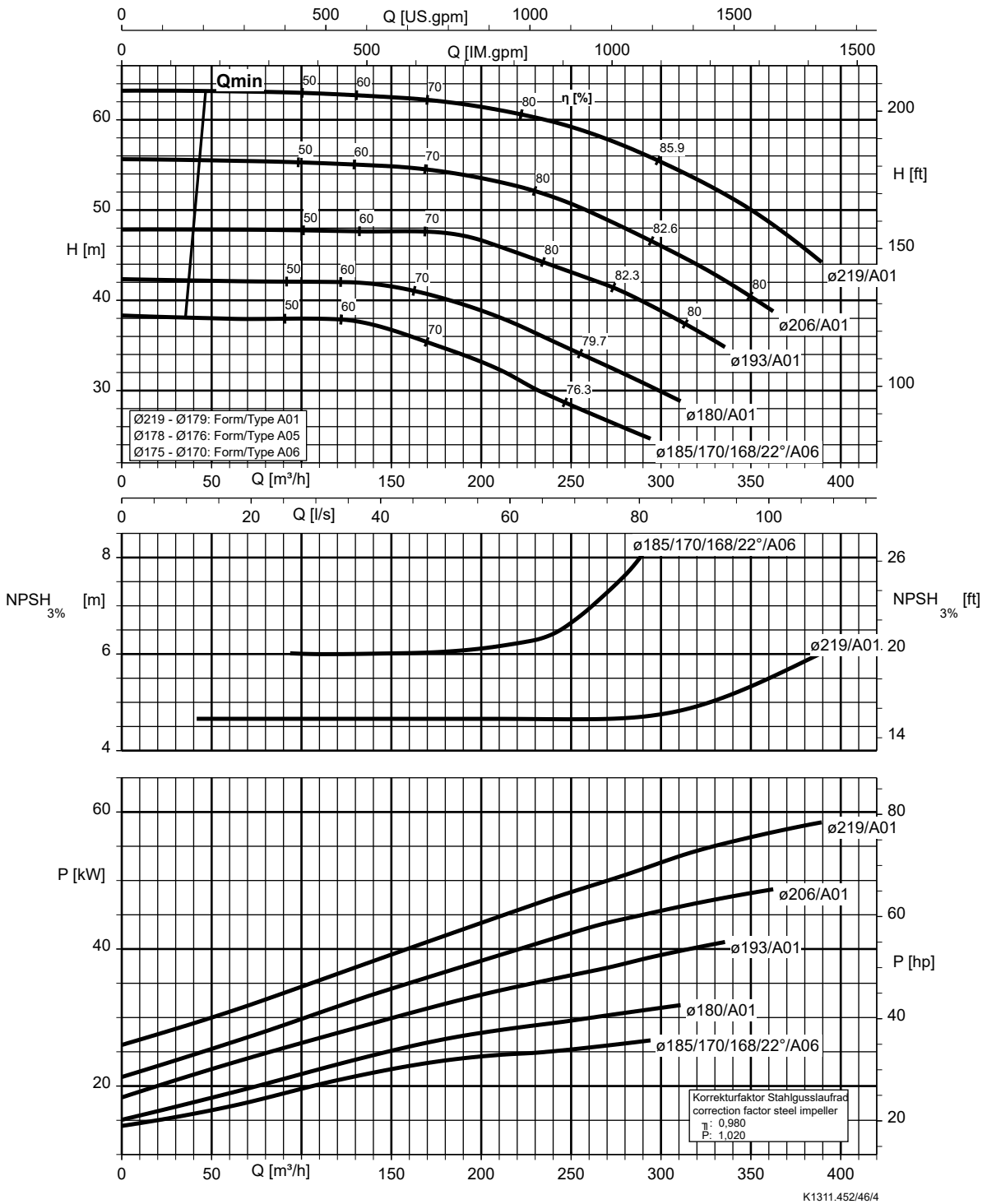

Vlet , Velta 125-100-250, n = 2900 rpm

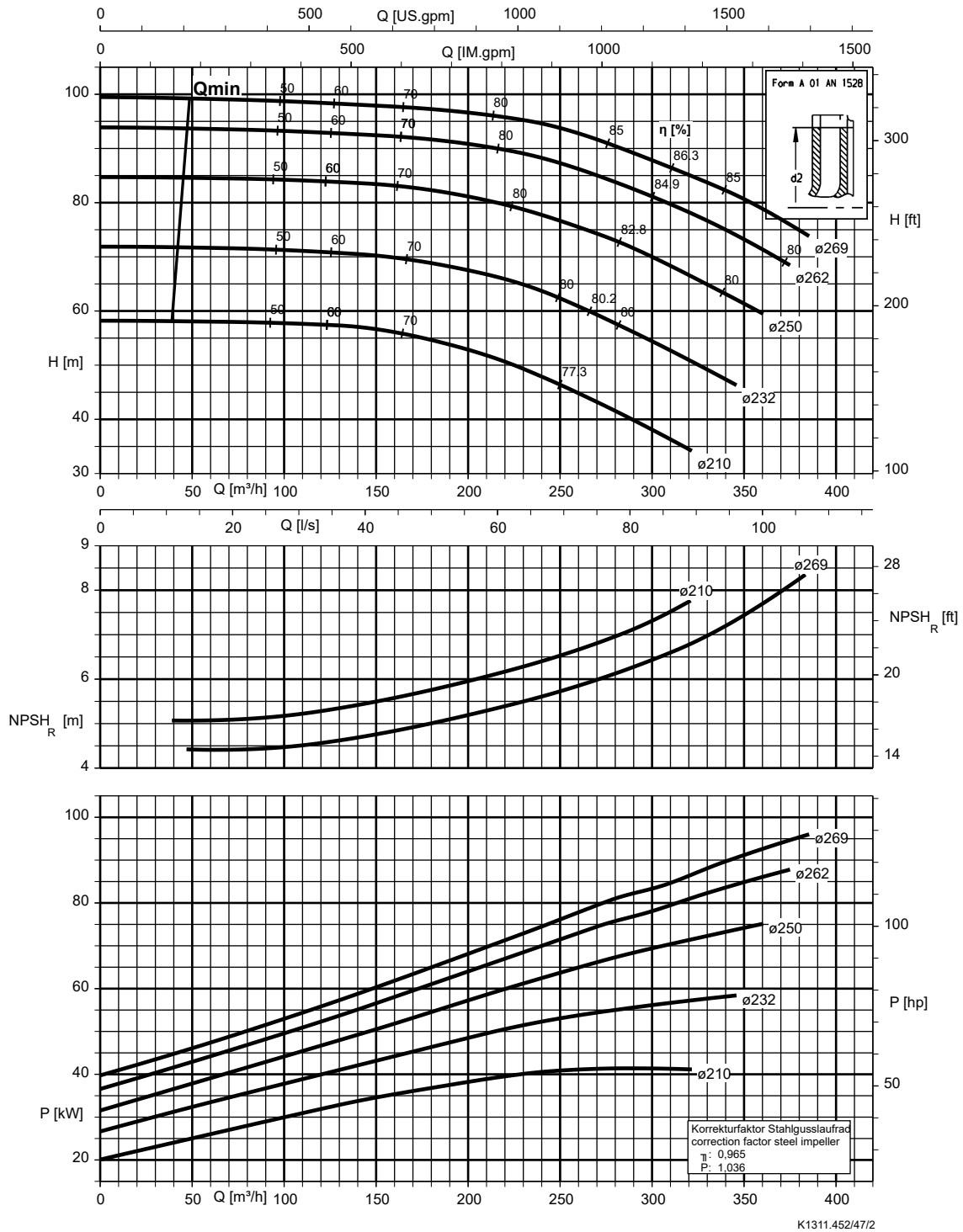

Vlet , Velta 125-100-315, n = 2900 rpm

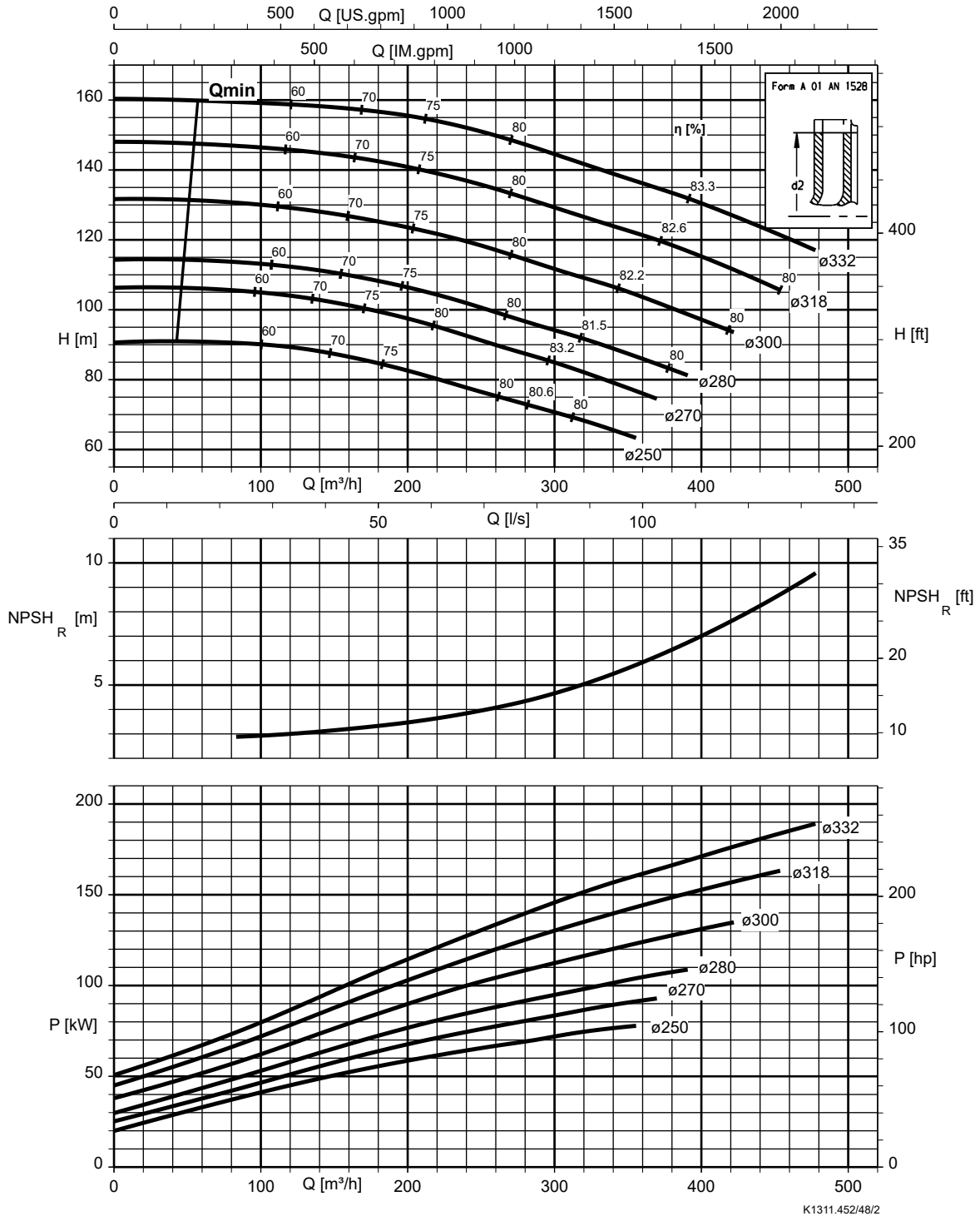

Vlet , Velta 150-125-200, n = 2900 rpm

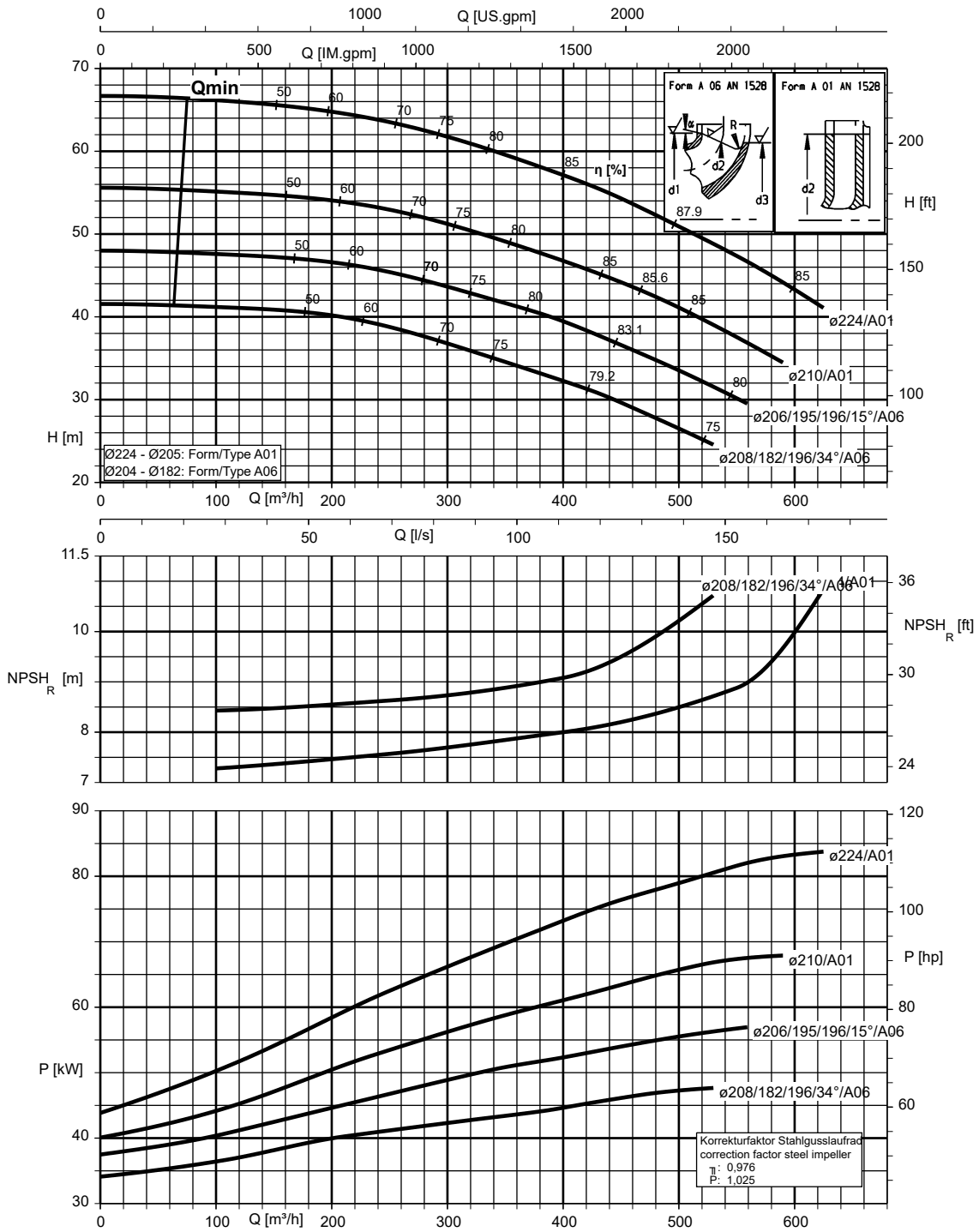



n = 1450 rpm

Vlet , Velta 040-025-160, n = 1450 rpm

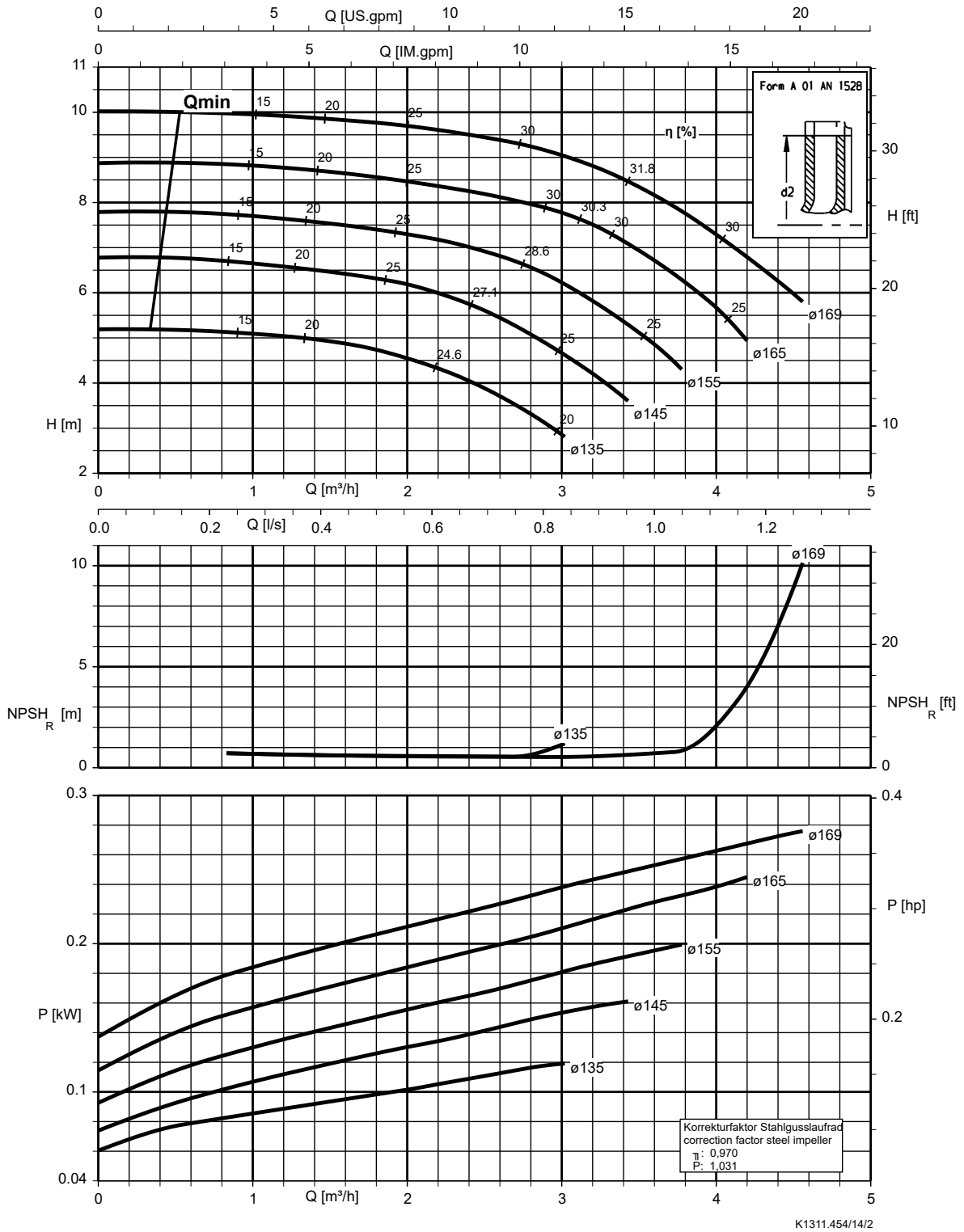

Vlet , Velta 040-025-200, n = 1450 rpm

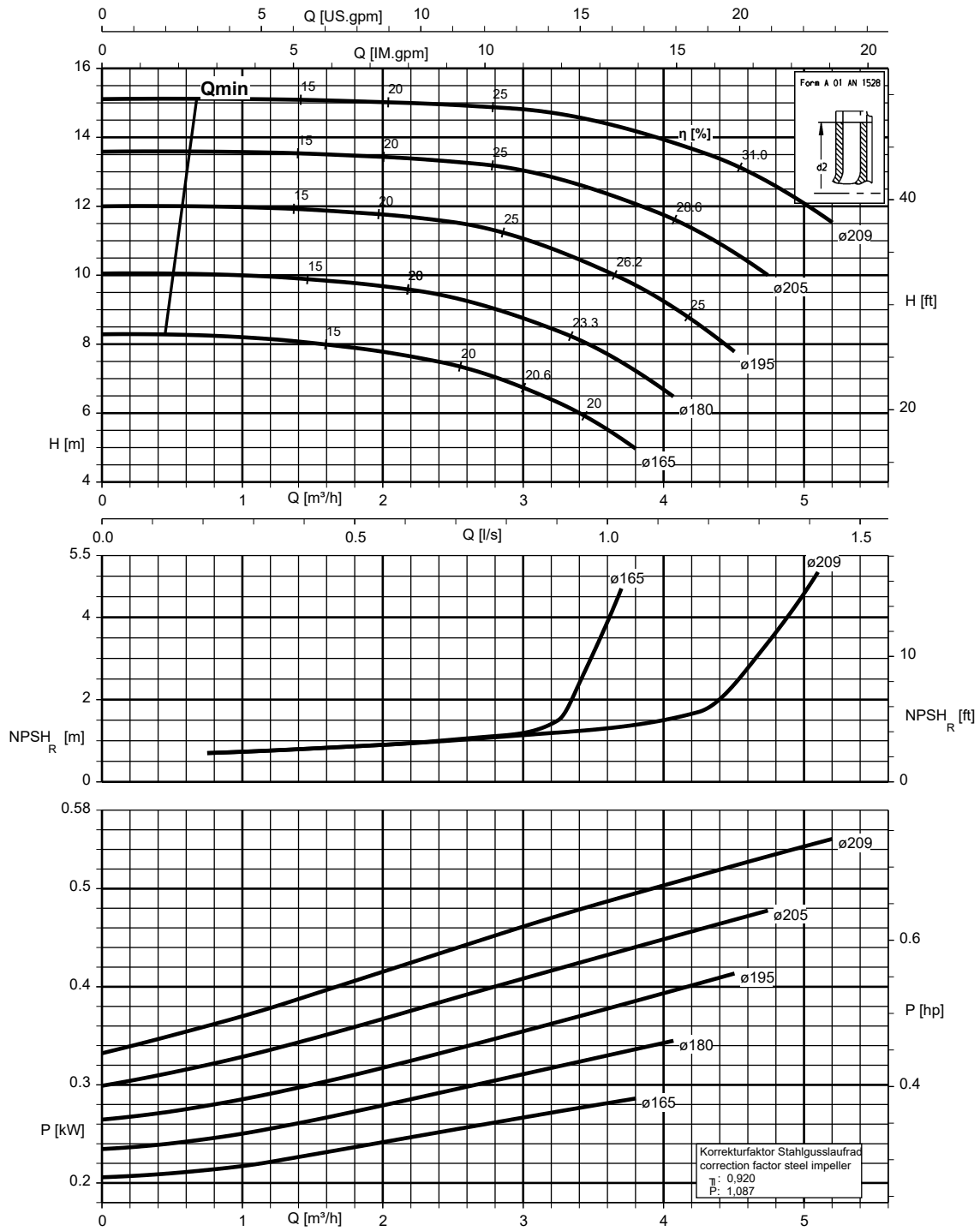

K1311.454/15/2

Vlet , Velta 050-032-125.1, n = 1450 rpm

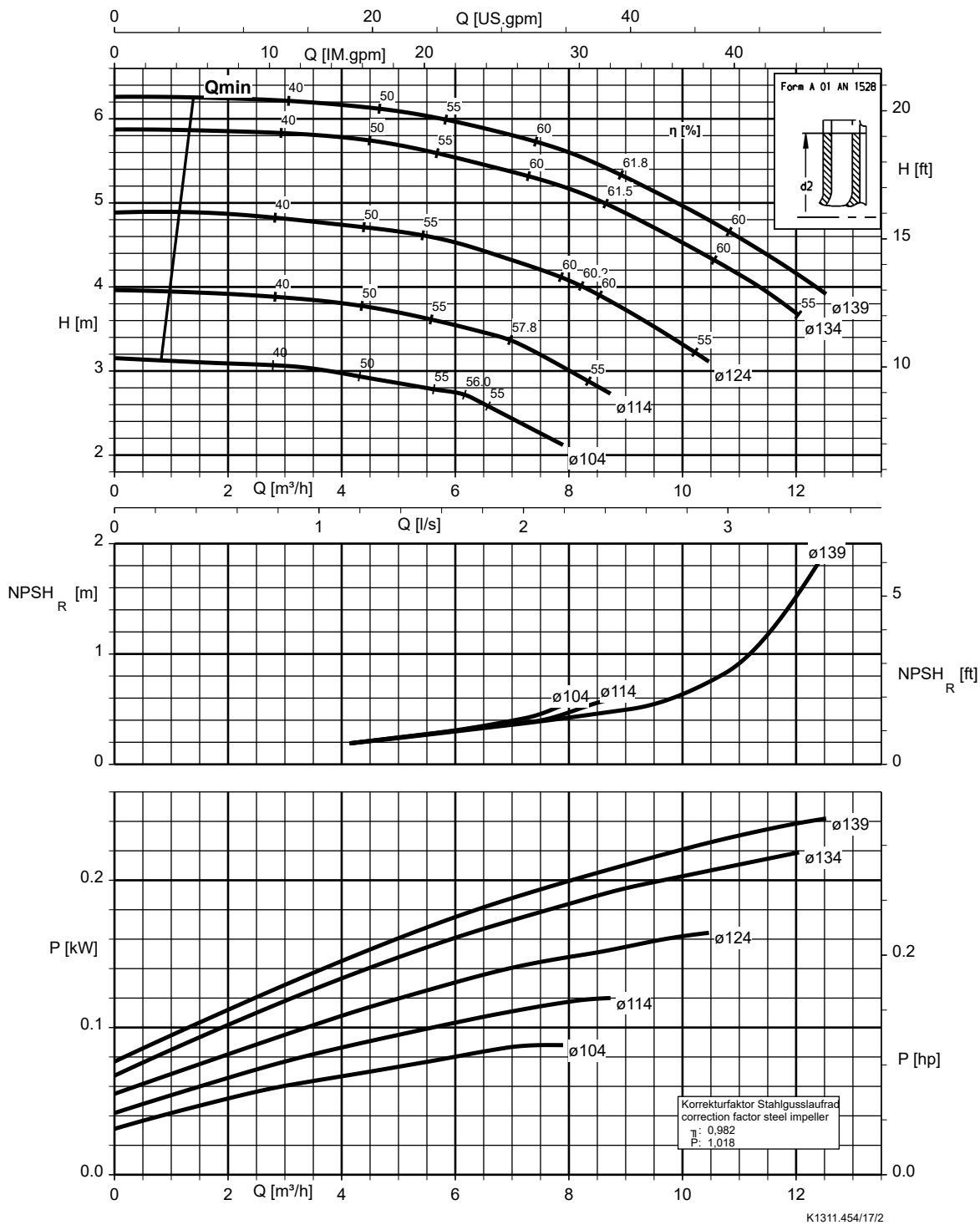

Vlet , Velta 050-032-160.1, n = 1450 rpm

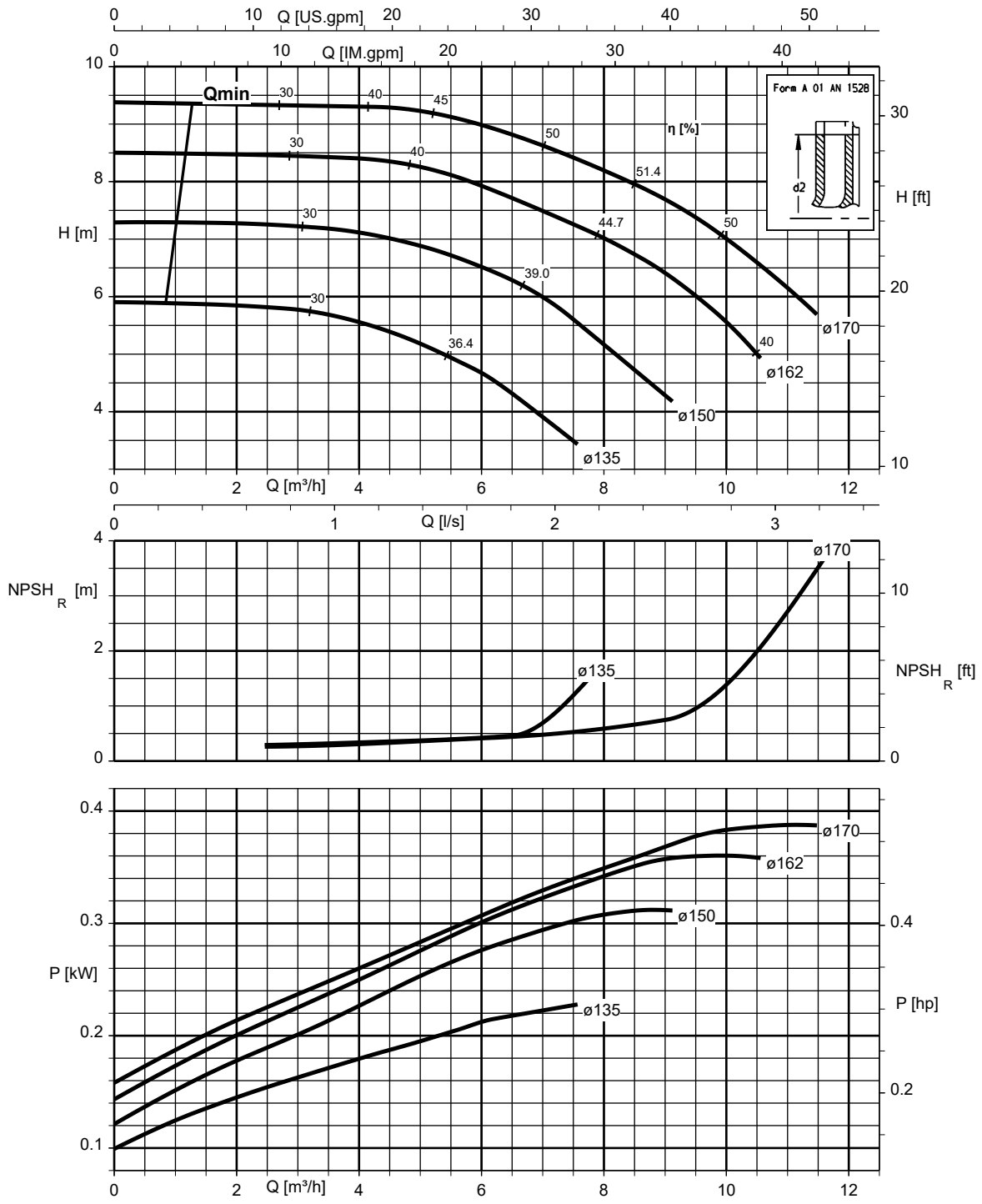

Vlet , Velta 050-032-200.1, n = 1450 rpm

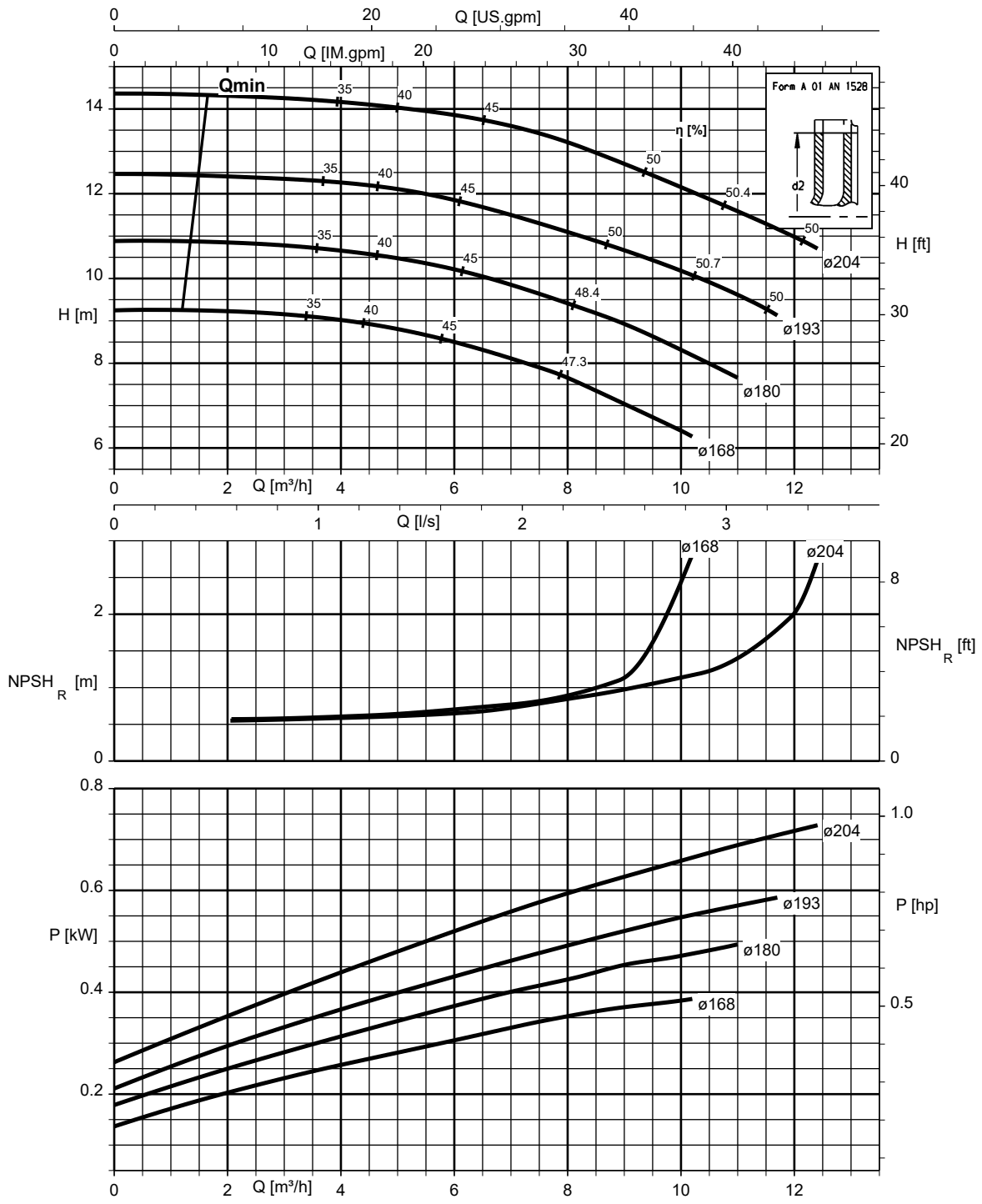

Vlet , Velta 050-032-250.1, n = 1450 rpm

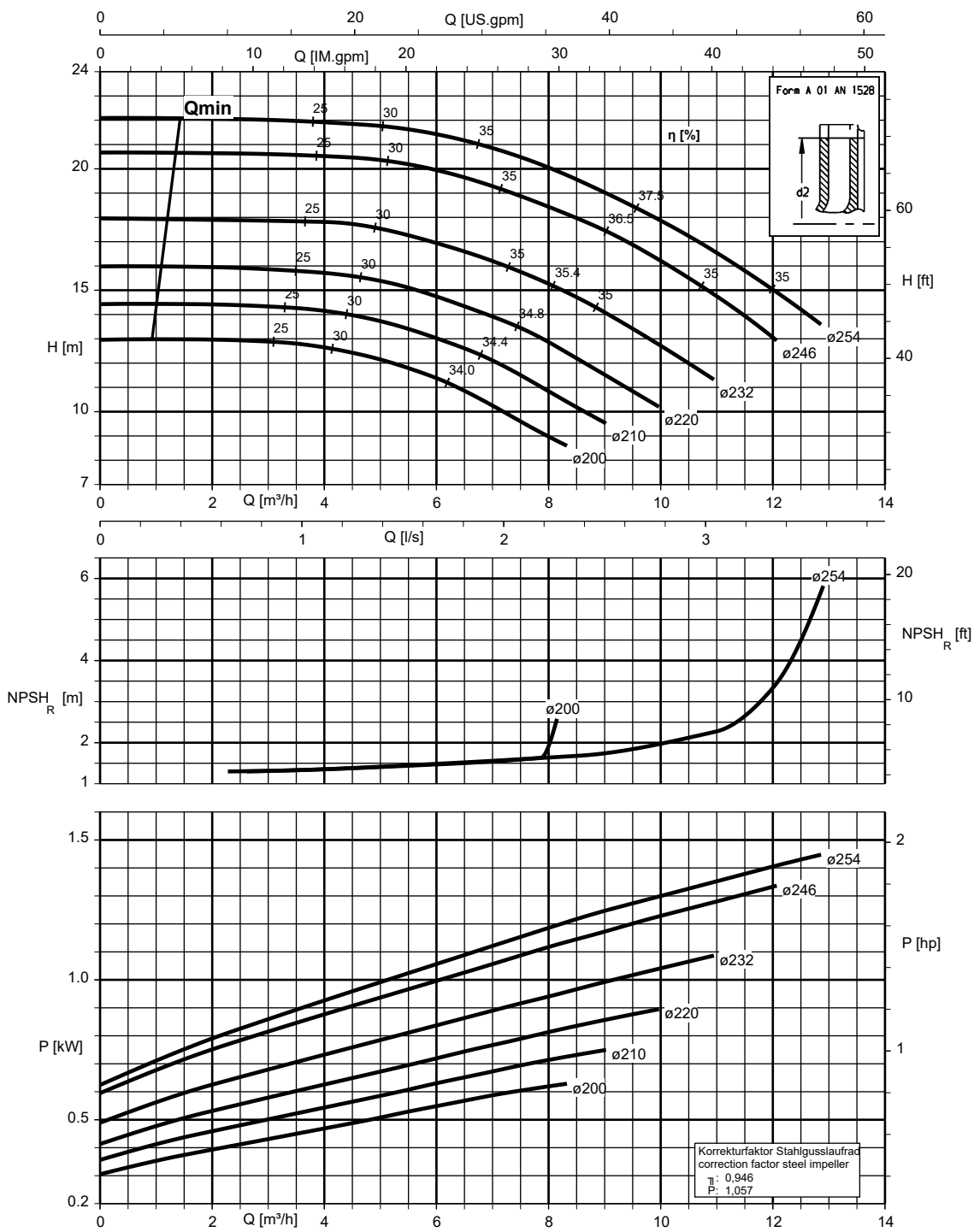

K1311.454/20/2

Vlet , Velta 050-032-125, n = 1450 rpm

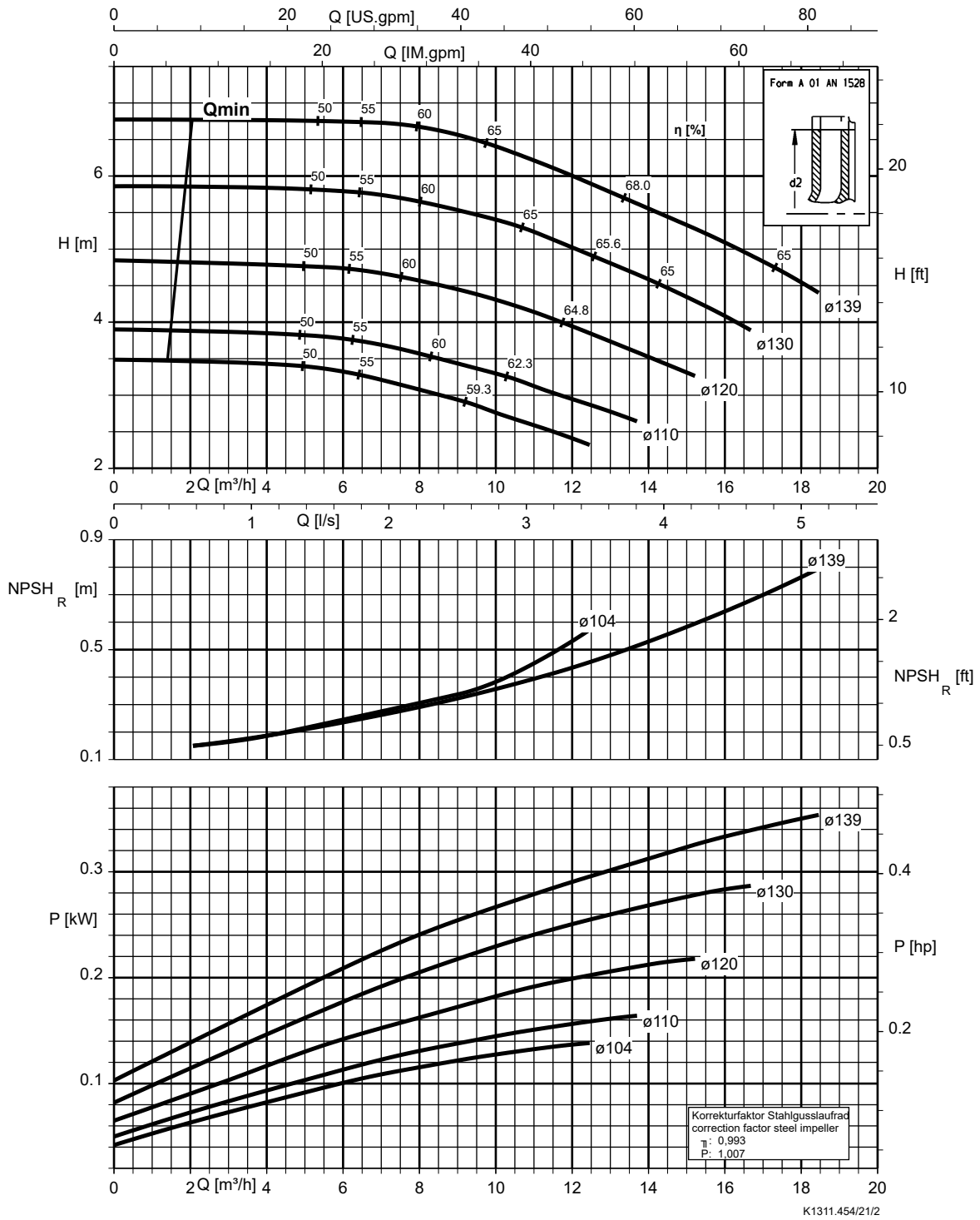

Vlet, Velta 050-032-160, n = 1450 rpm

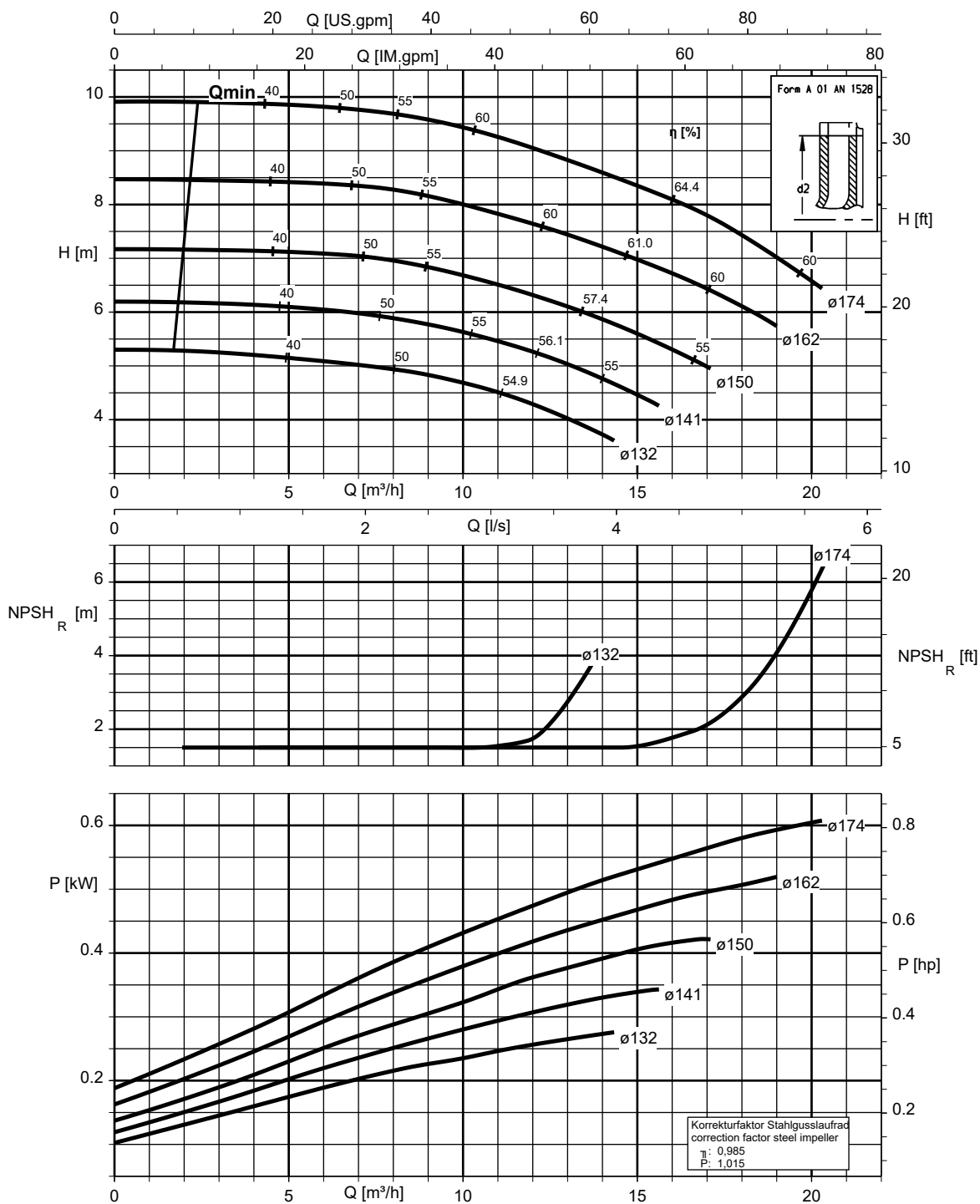

K1311.454/22/3



Vlet , Velta 050-032-200, n = 1450 rpm

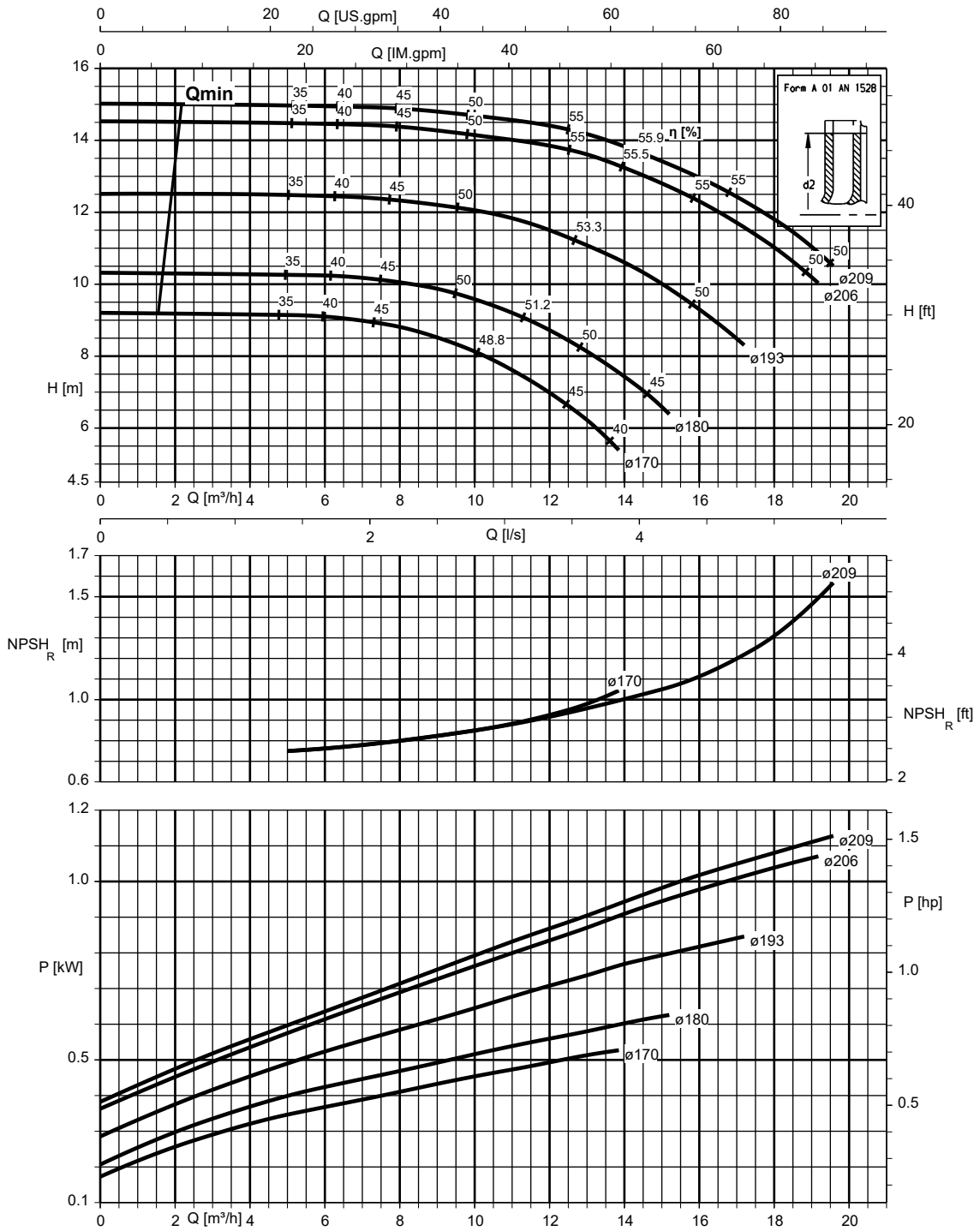

Vlet , Velta 050-032-250, n = 1450 rpm

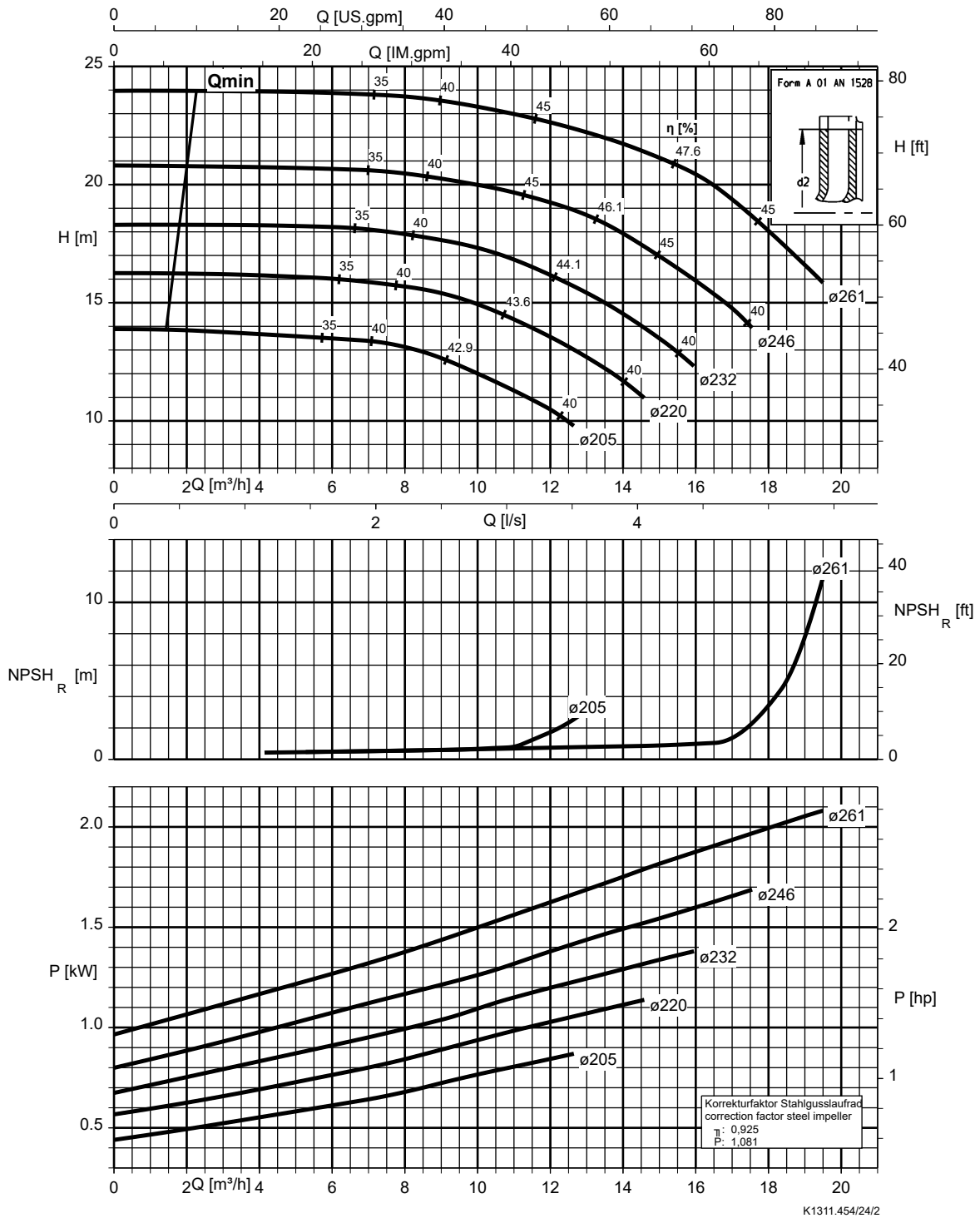

Vlet , Velta 065-040-125, n = 1450 rpm

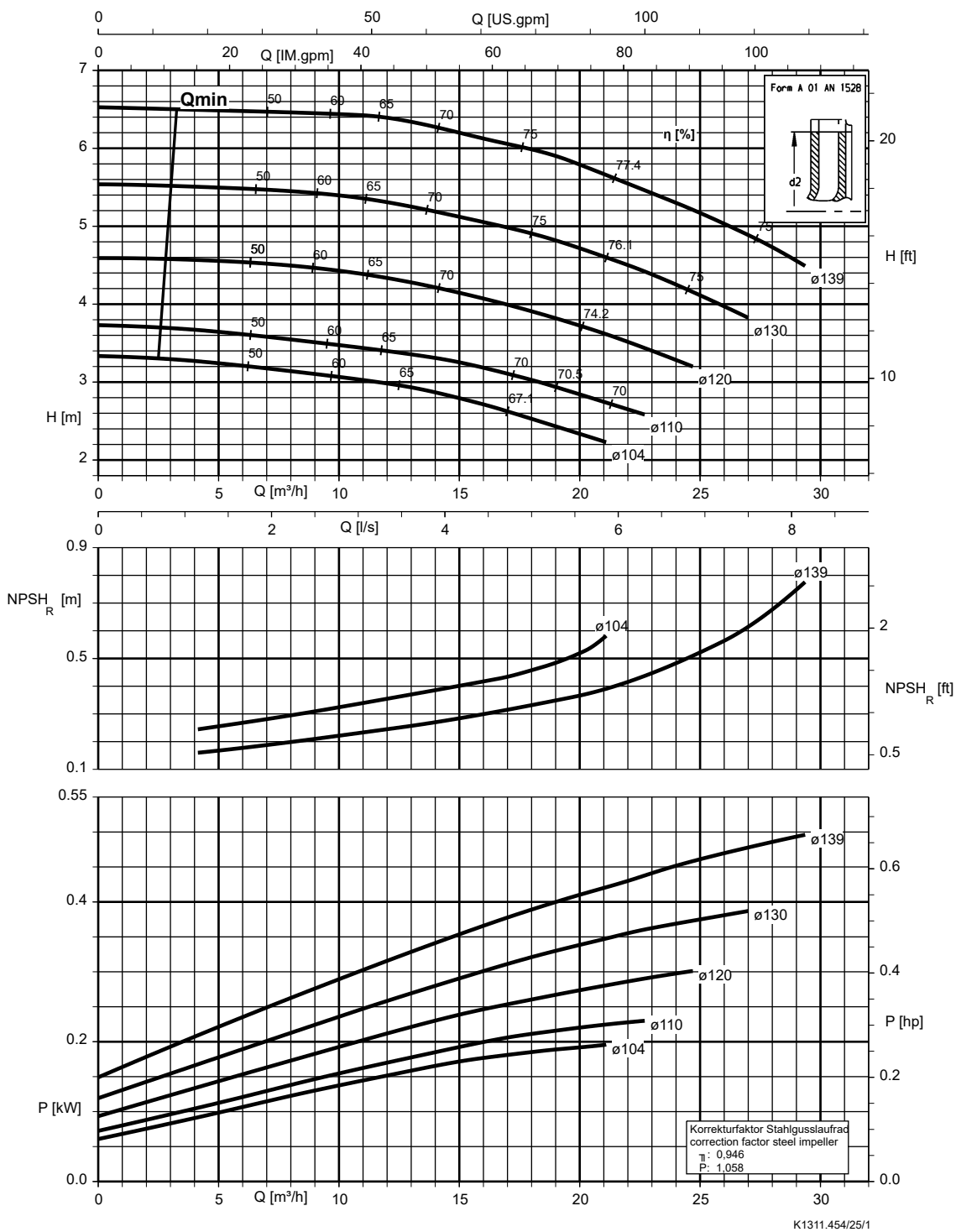

Vlet , Velta 065-040-160, n = 1450 rpm

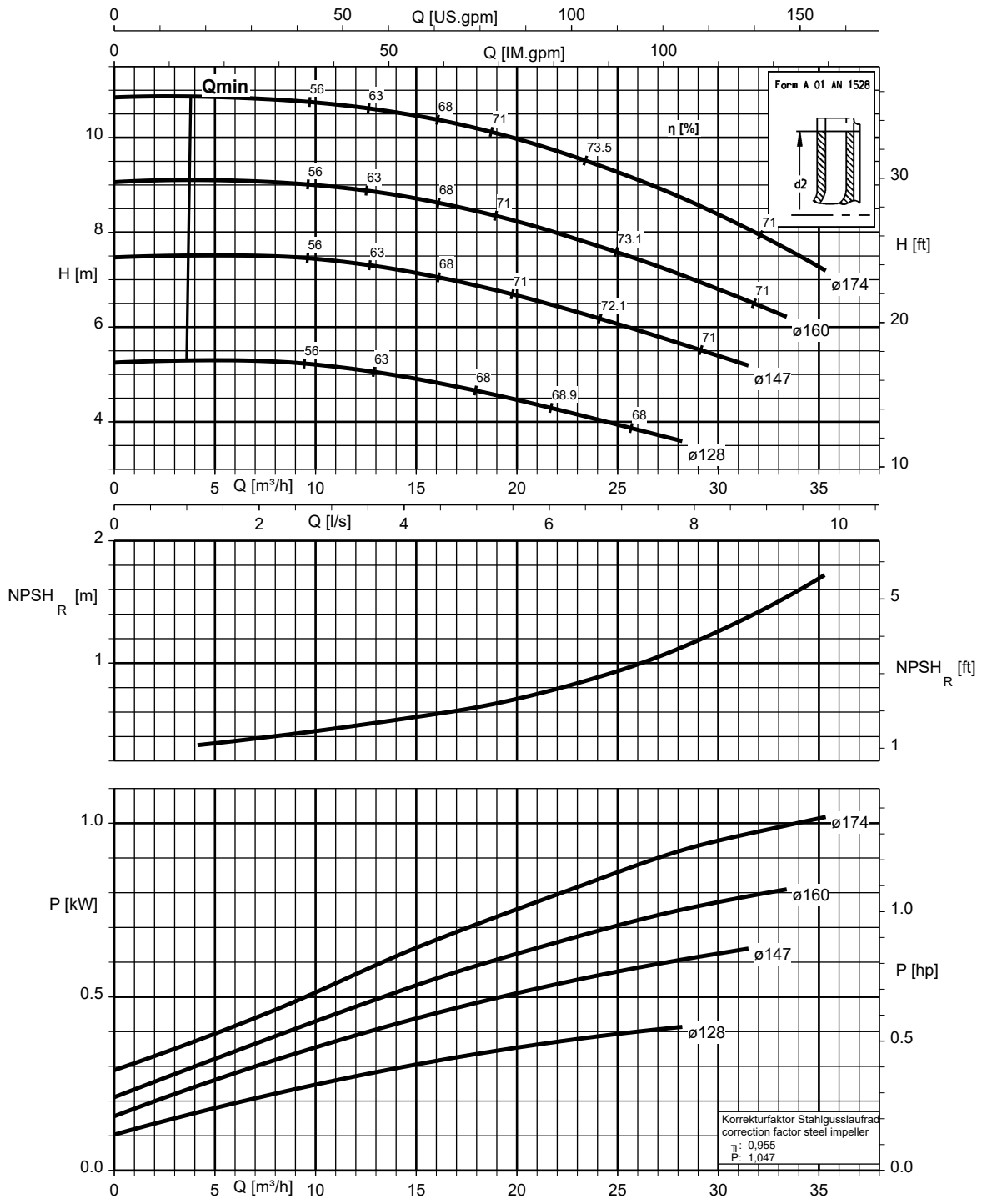

Vlet, Velta 065-040-200, n = 1450 rpm

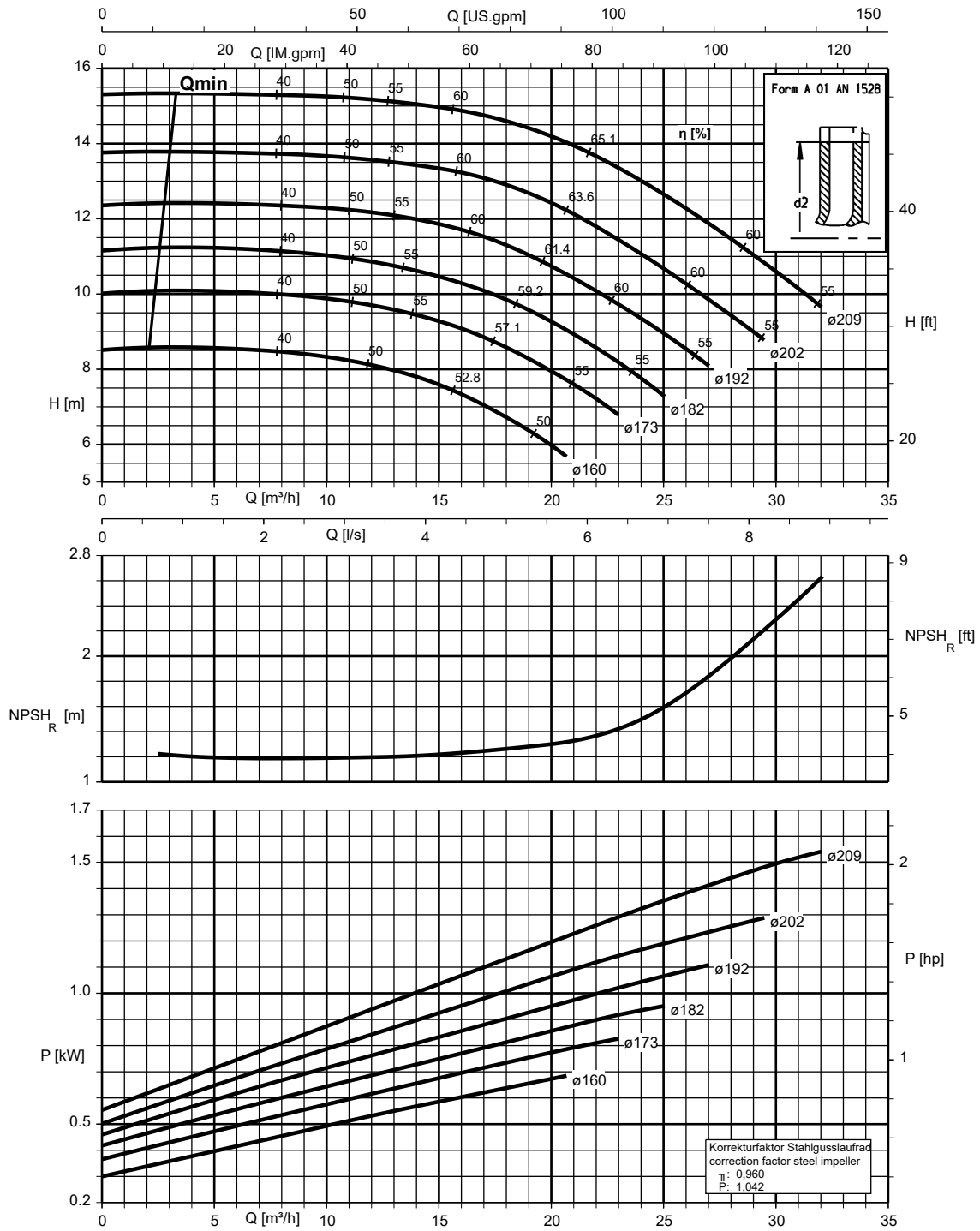

Vlet , Velta 065-040-250, n = 1450 rpm

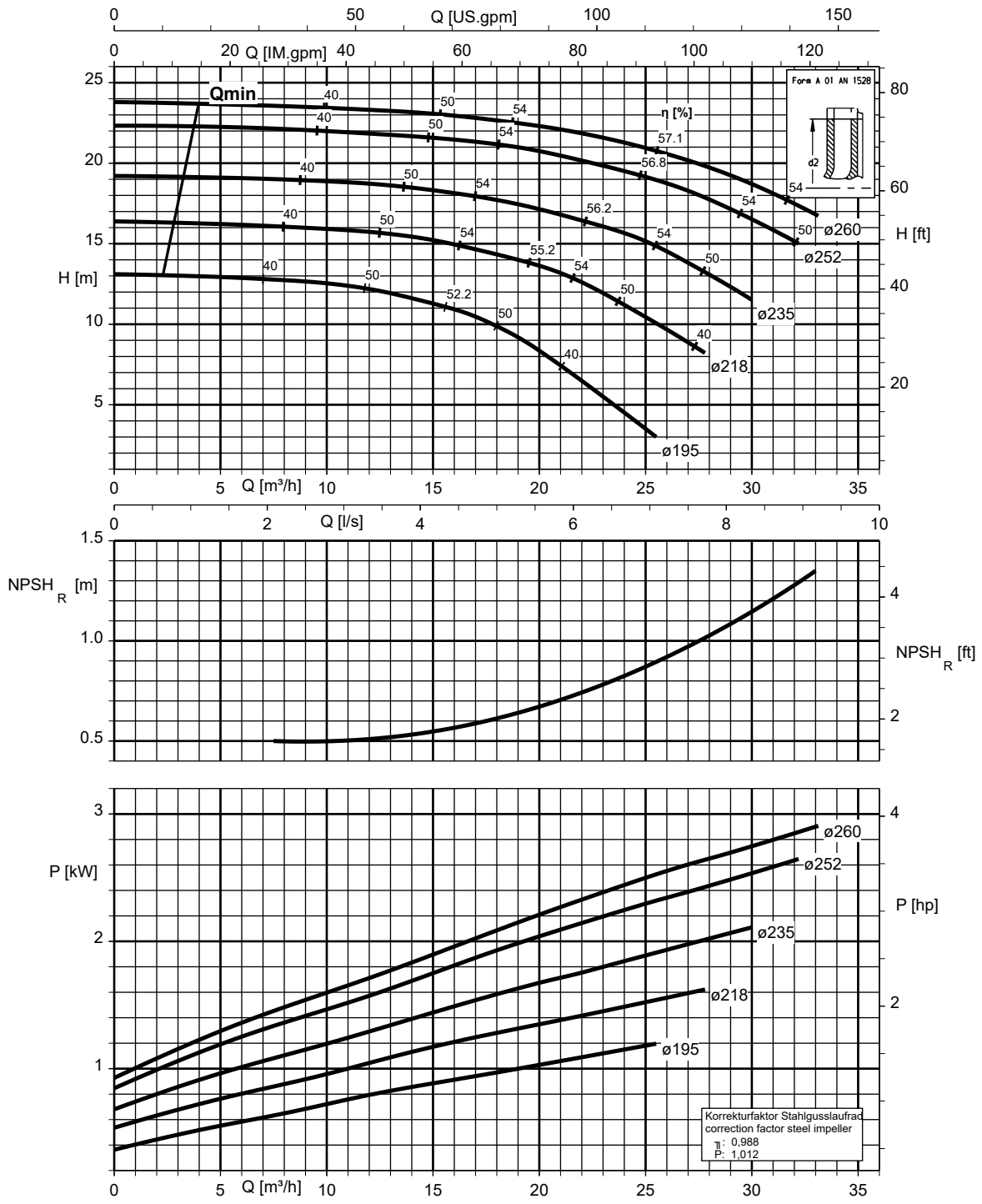

Vlet , Velta 065-040-315, n = 1450 rpm

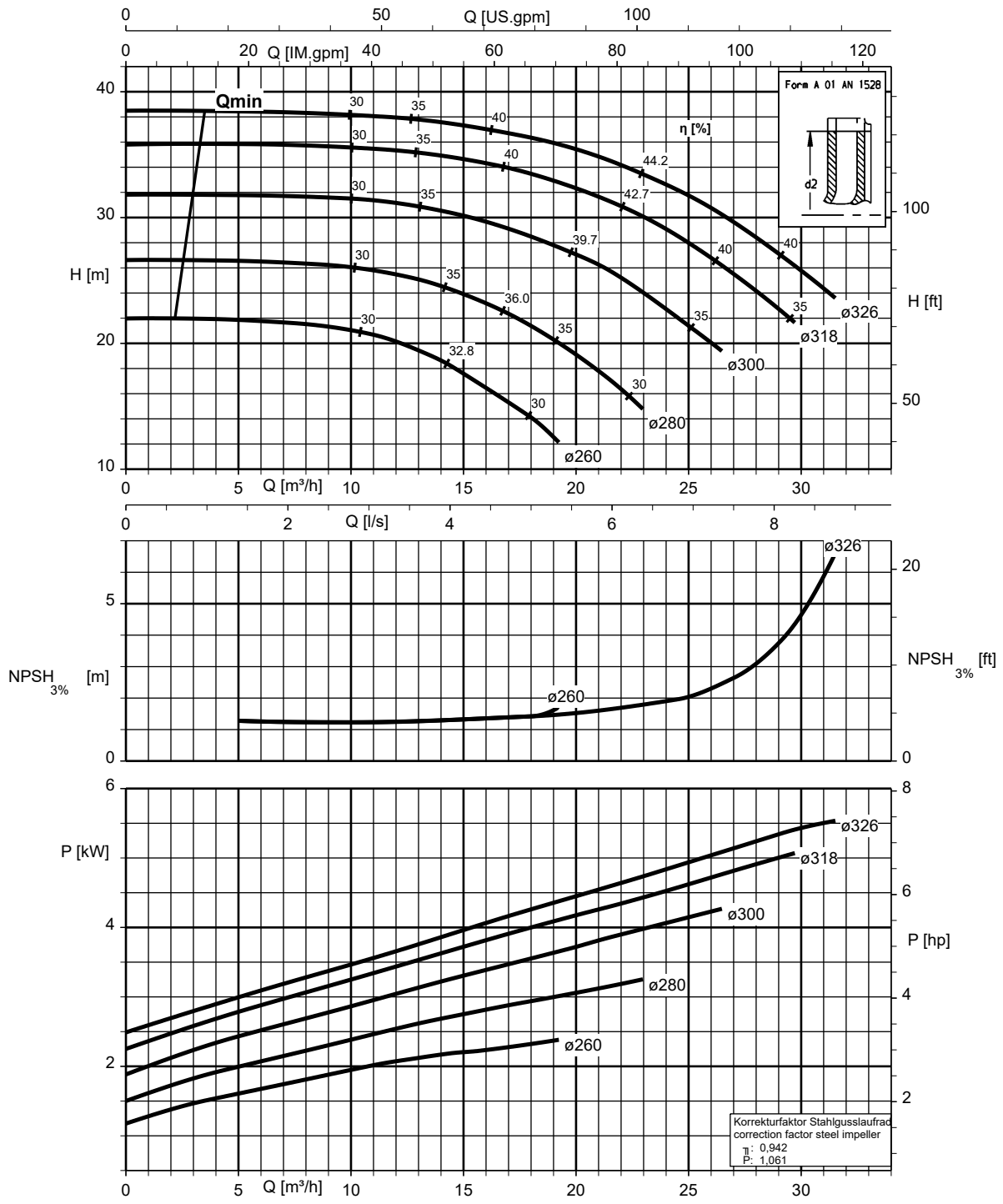

K1311.454/29/3

Vlet , Velta 065-050-125, n = 1450 rpm

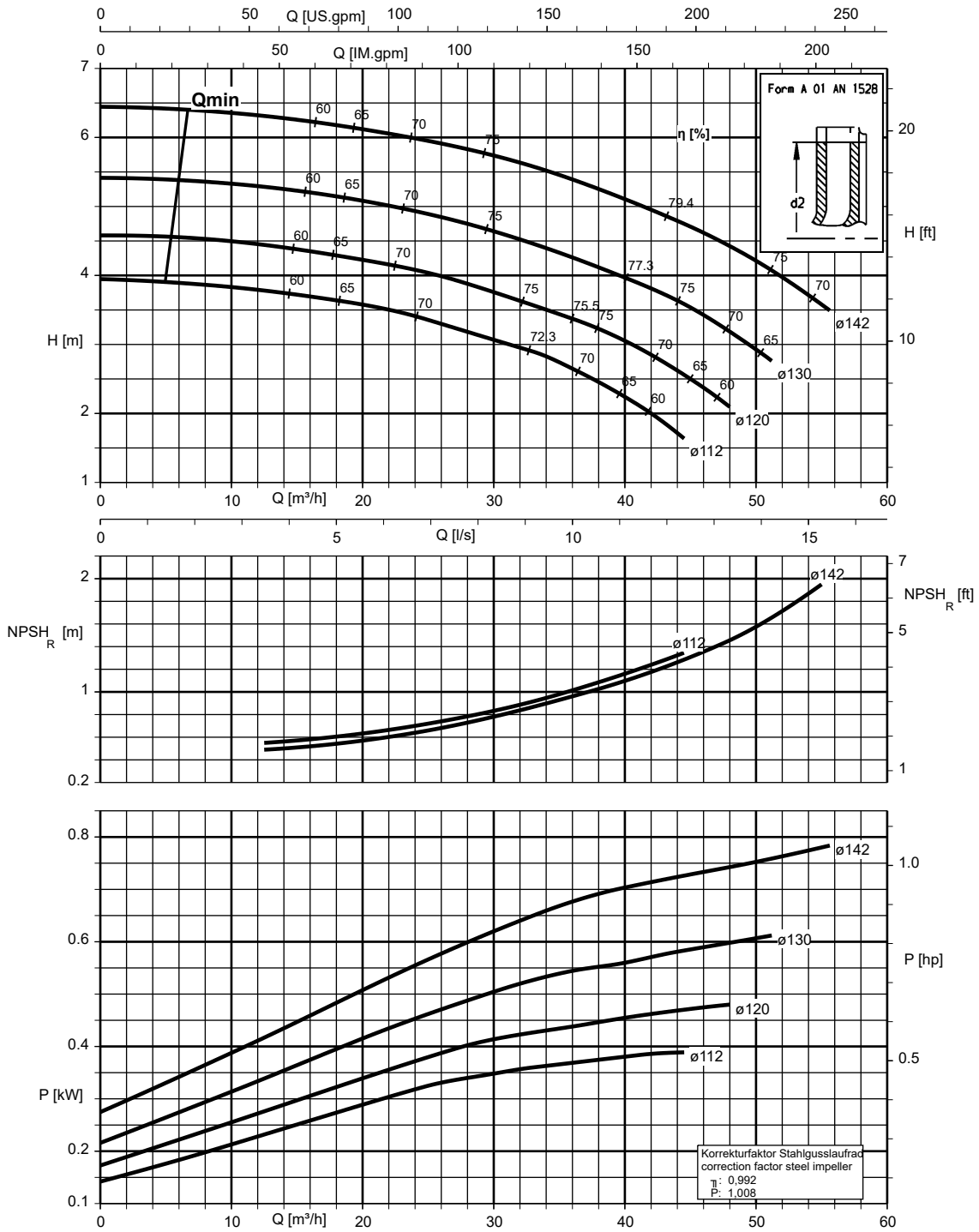

K1311.454/30/1



Vlet , Velta 065-050-160, n = 1450 rpm

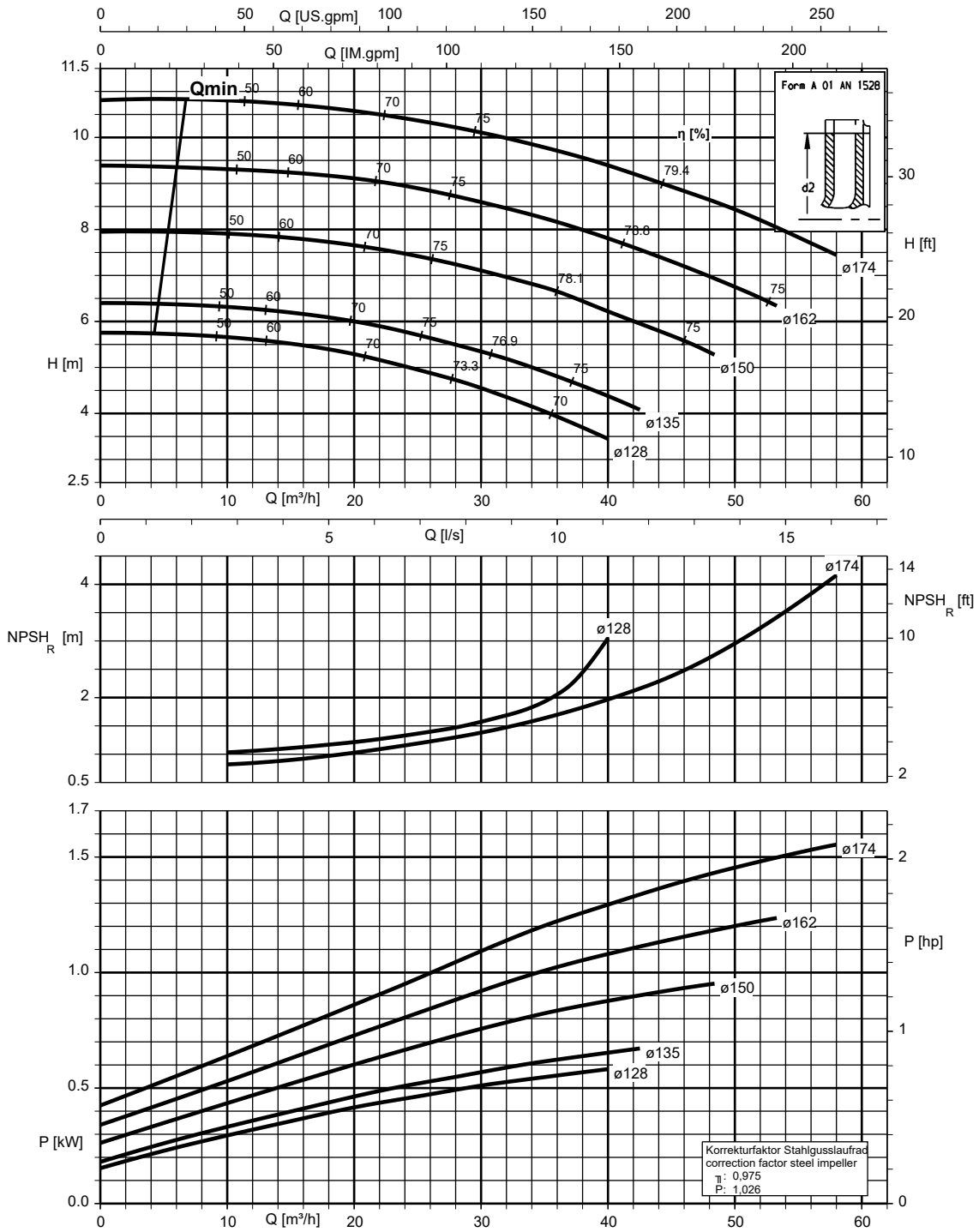

Vlet , Velta 065-050-200, n = 1450 rpm

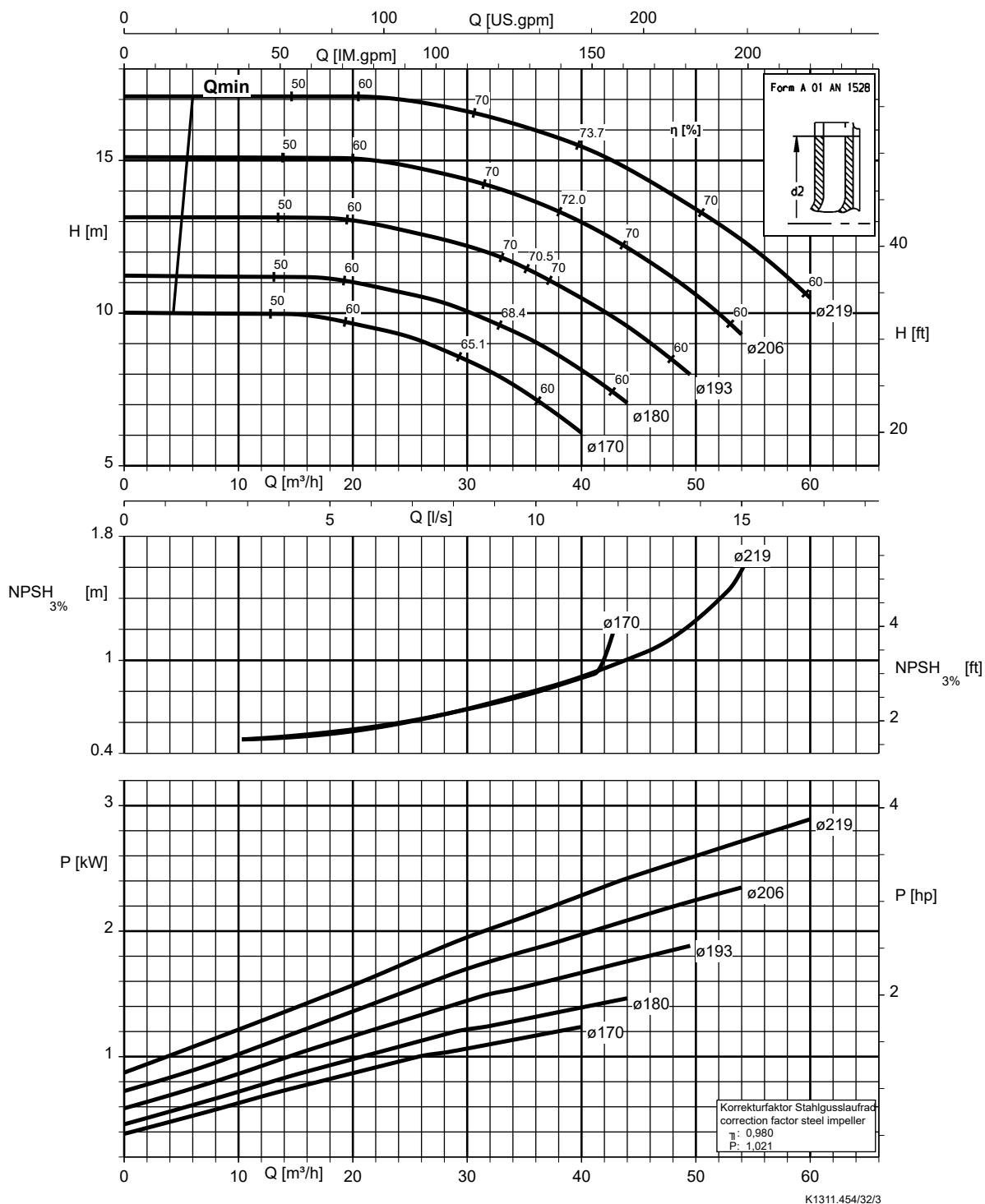

Vlet , Velta 065-050-250, n = 1450 rpm

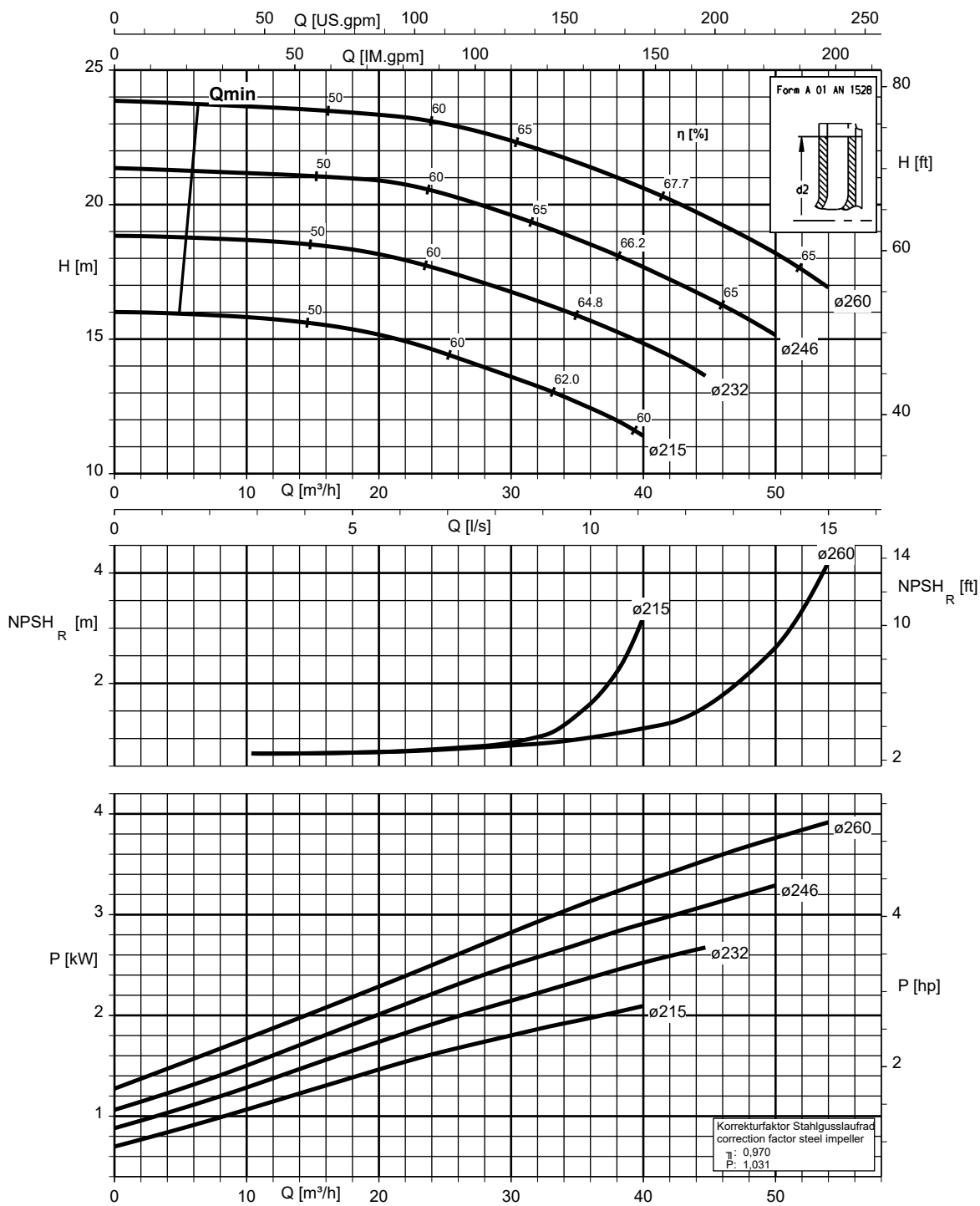

K1311.454/33/2

Vlet , Velta 065-050-315, n = 1450 rpm

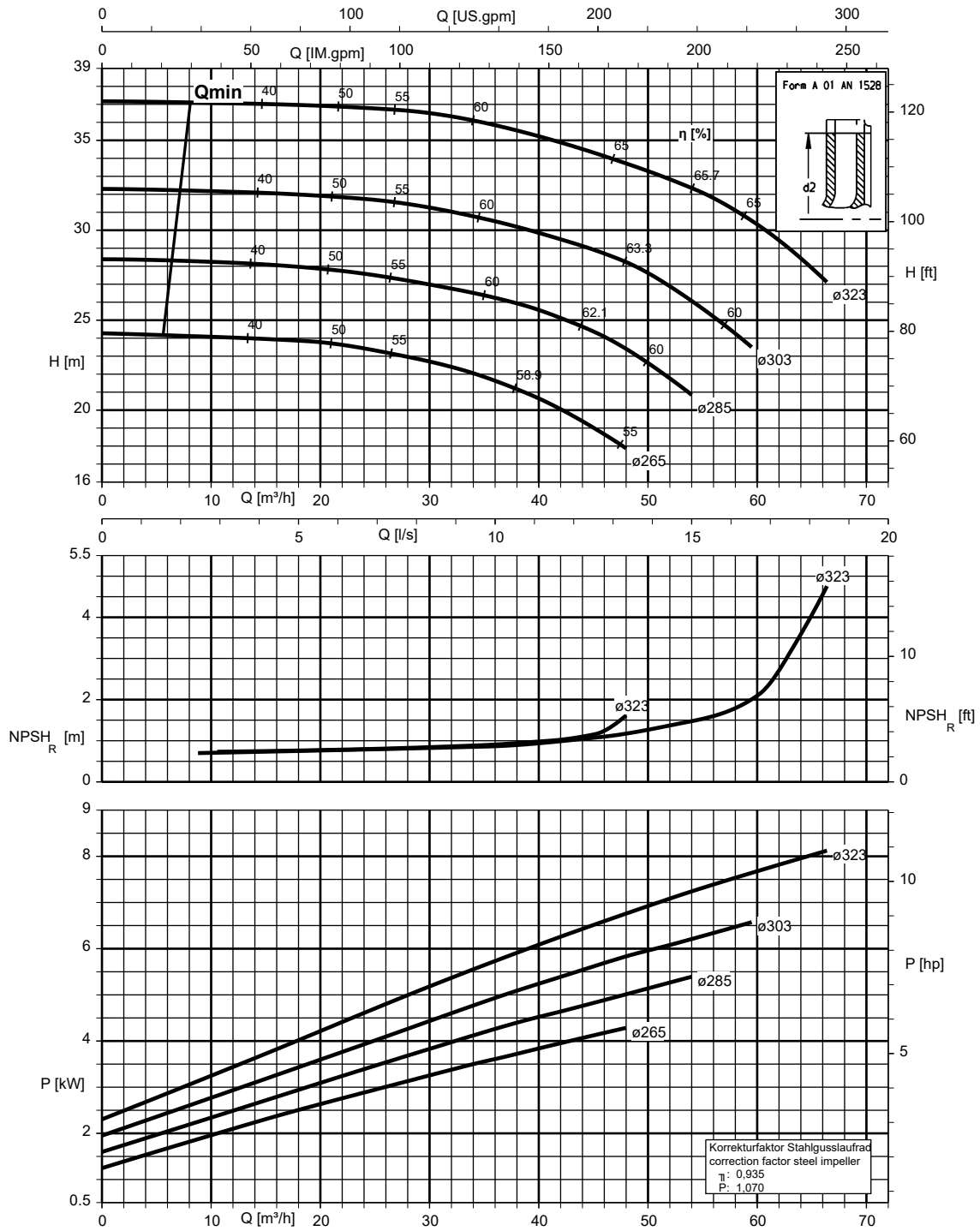

K1311.454/34/2

Vlet, Velta 080-065-125, n = 1450 rpm

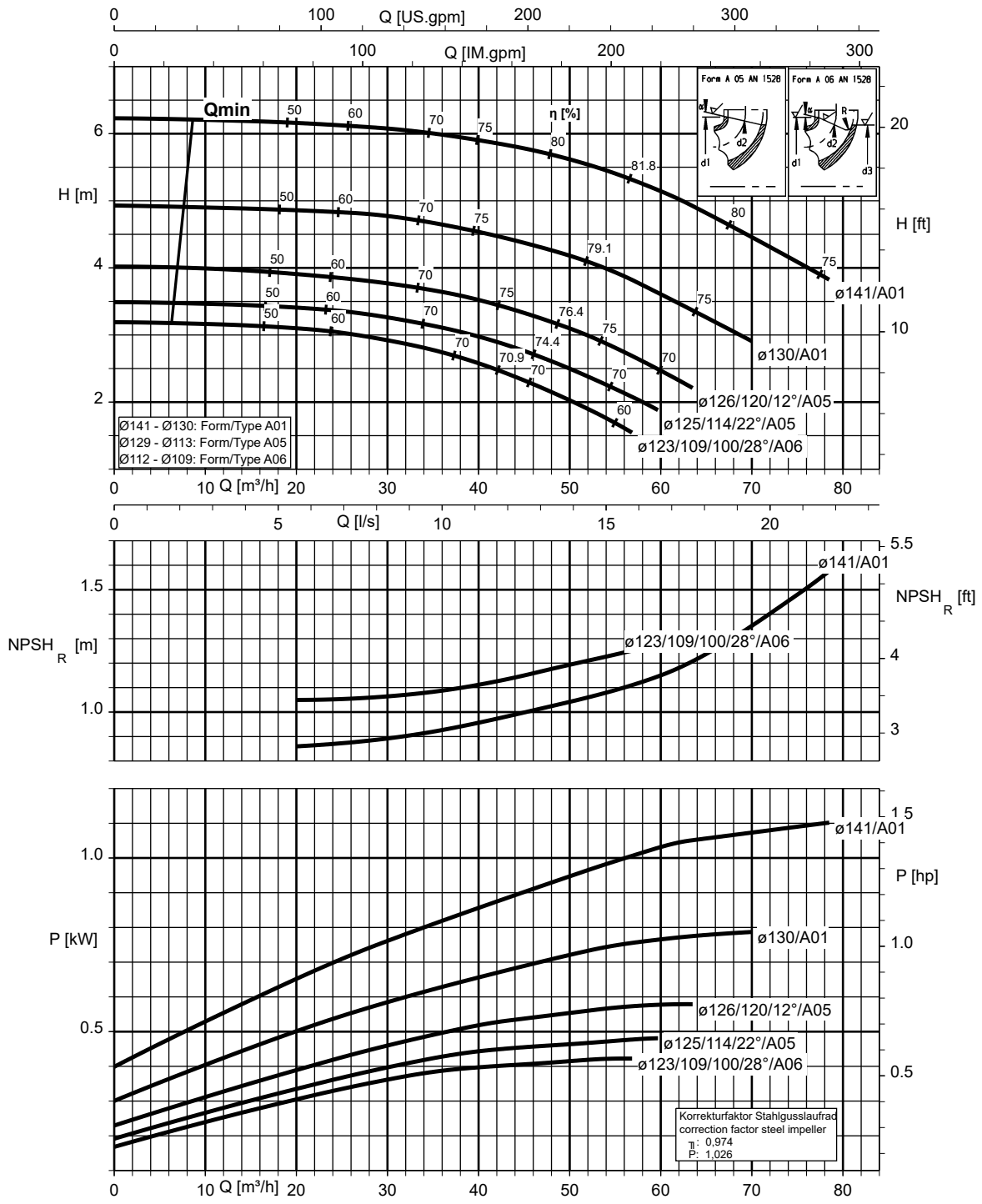

K1311.454/35/3

Vlet , Velta 080-065-160, n = 1450 rpm

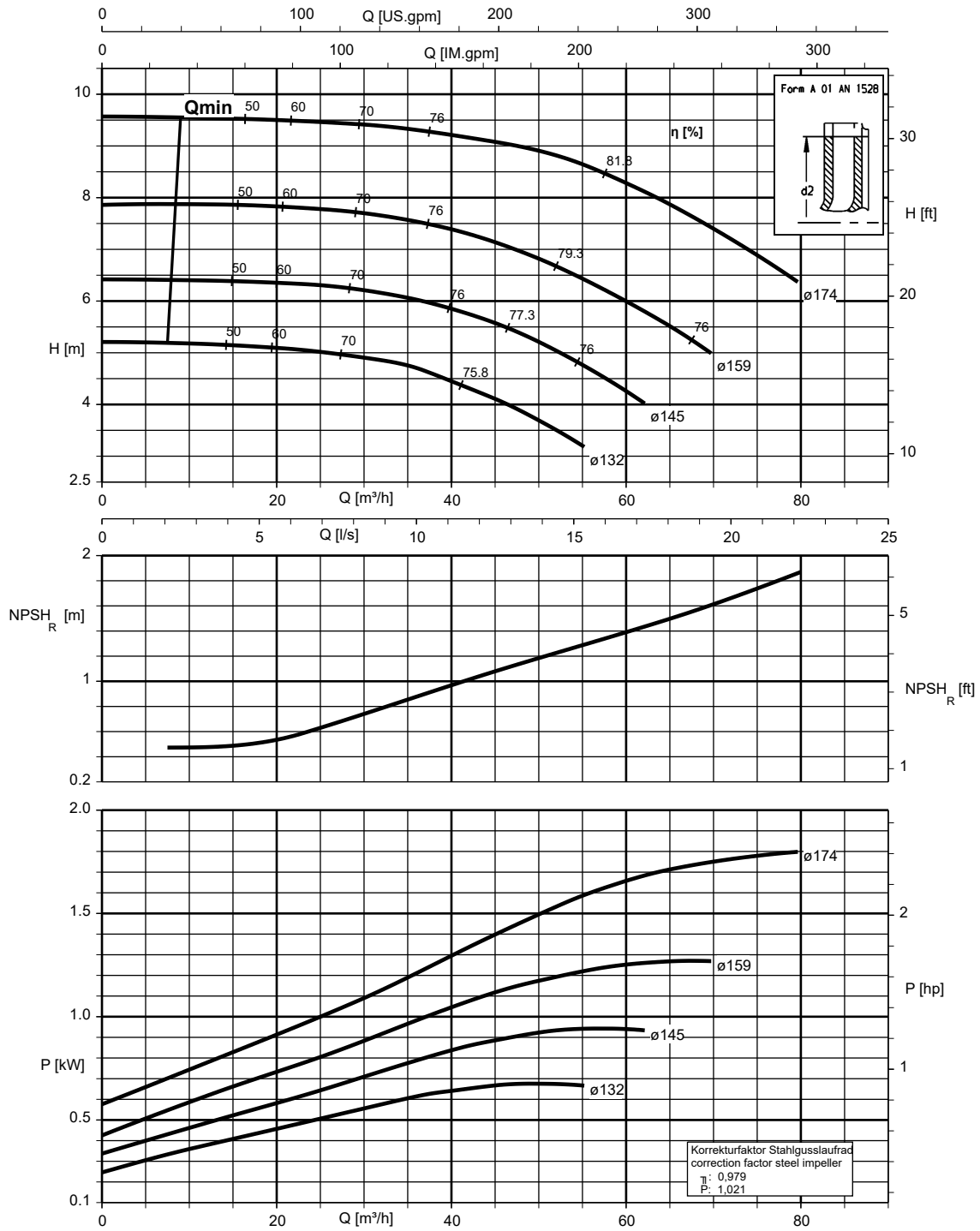

K1311.454/36/2

Vlet , Velta 080-065-200, n = 1450 rpm

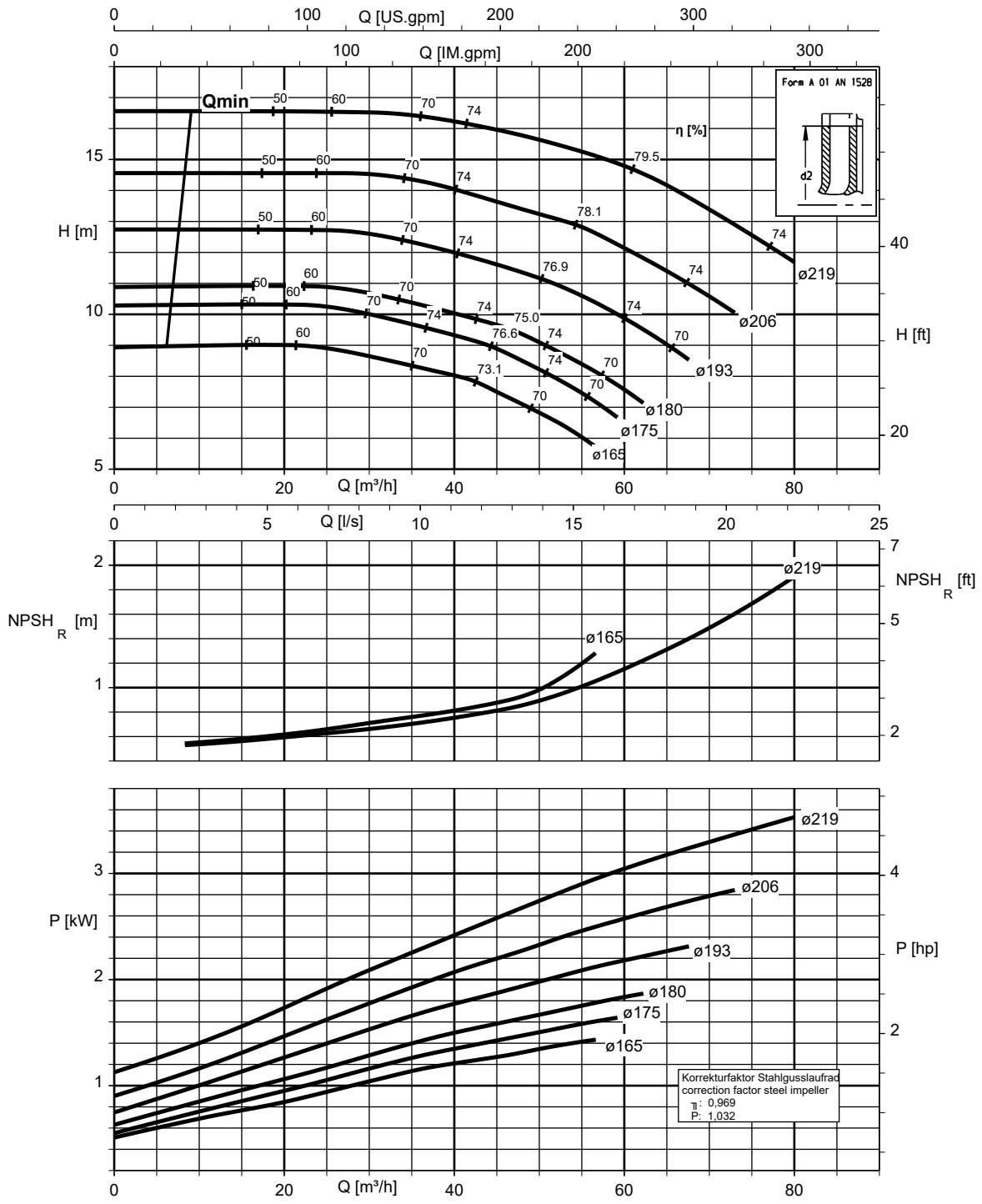

Vlet , Velta 080-065-250, n = 1450 rpm

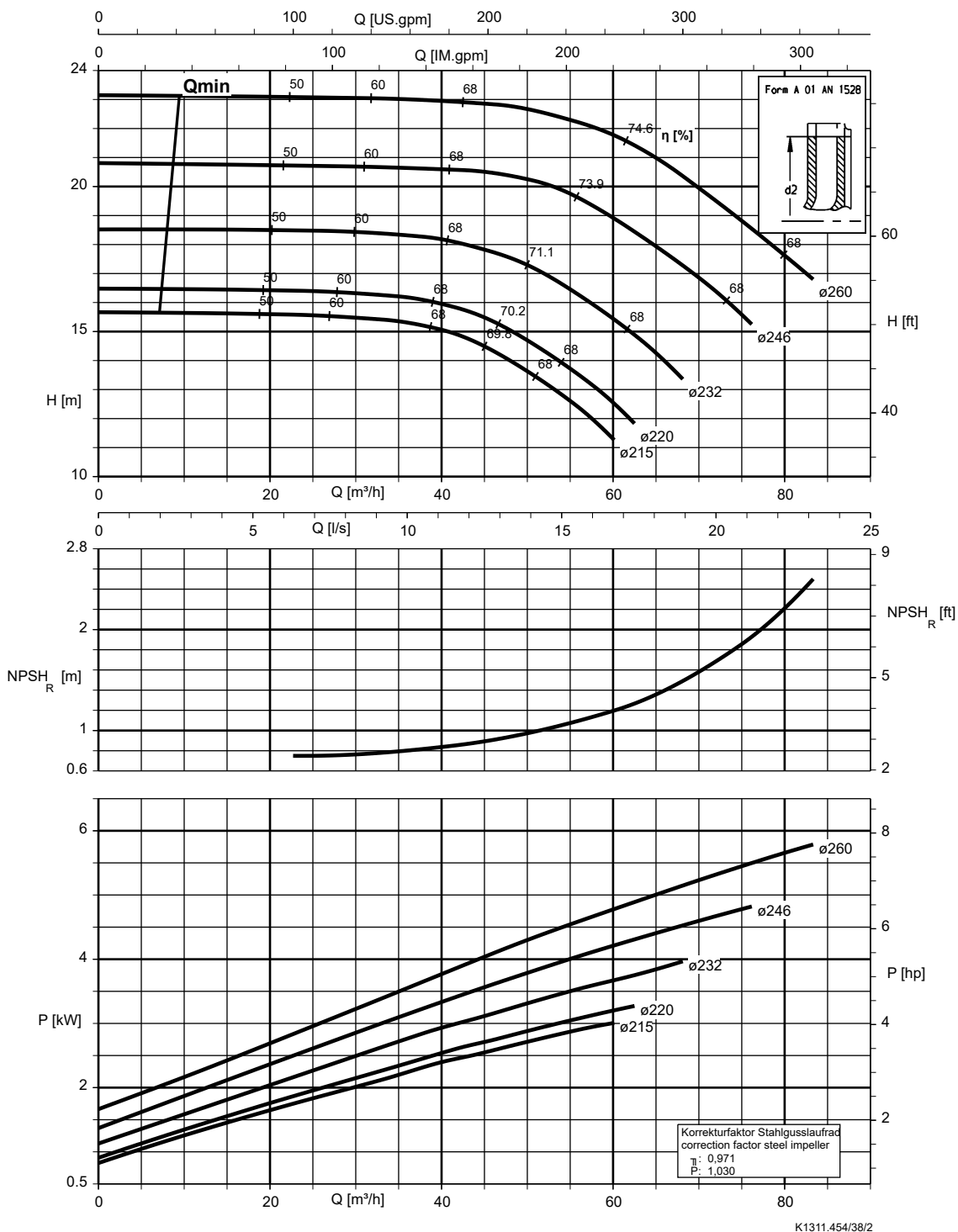



Vlet , Velta 080-065-315, n = 1450 rpm

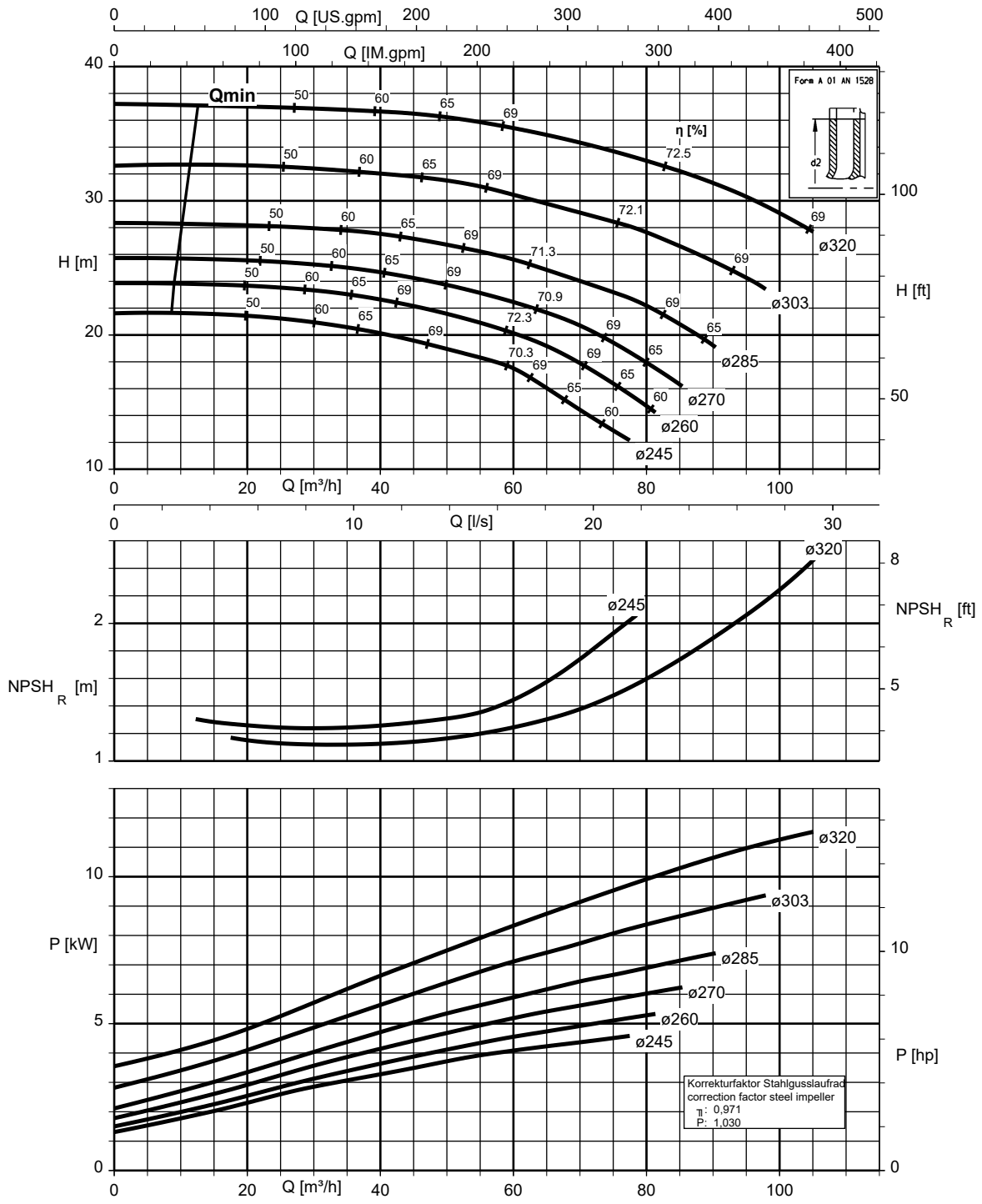

Vlet , Velta 100-080-160, n = 1450 rpm

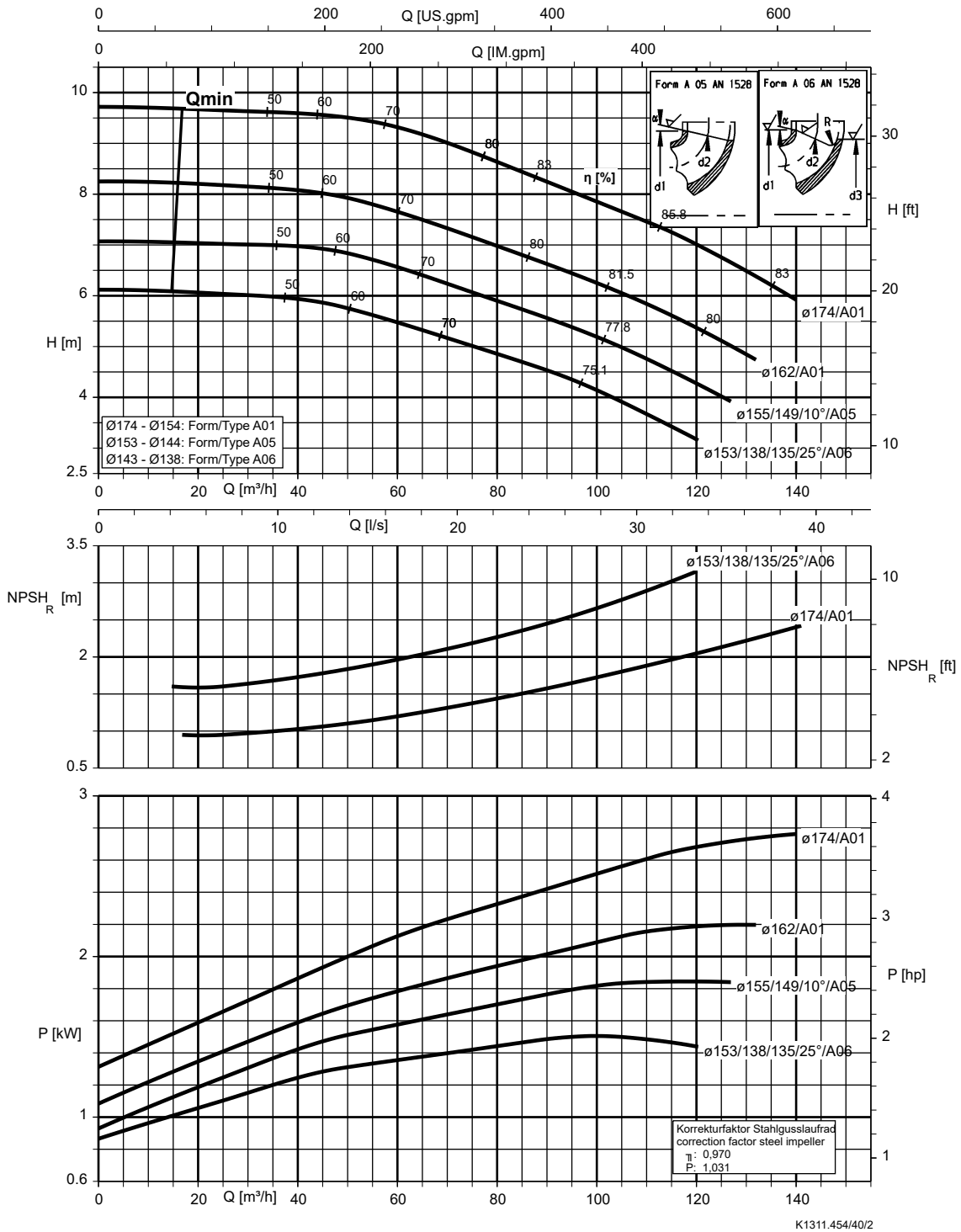

Vlet , Velta 100-080-200, n = 1450 rpm

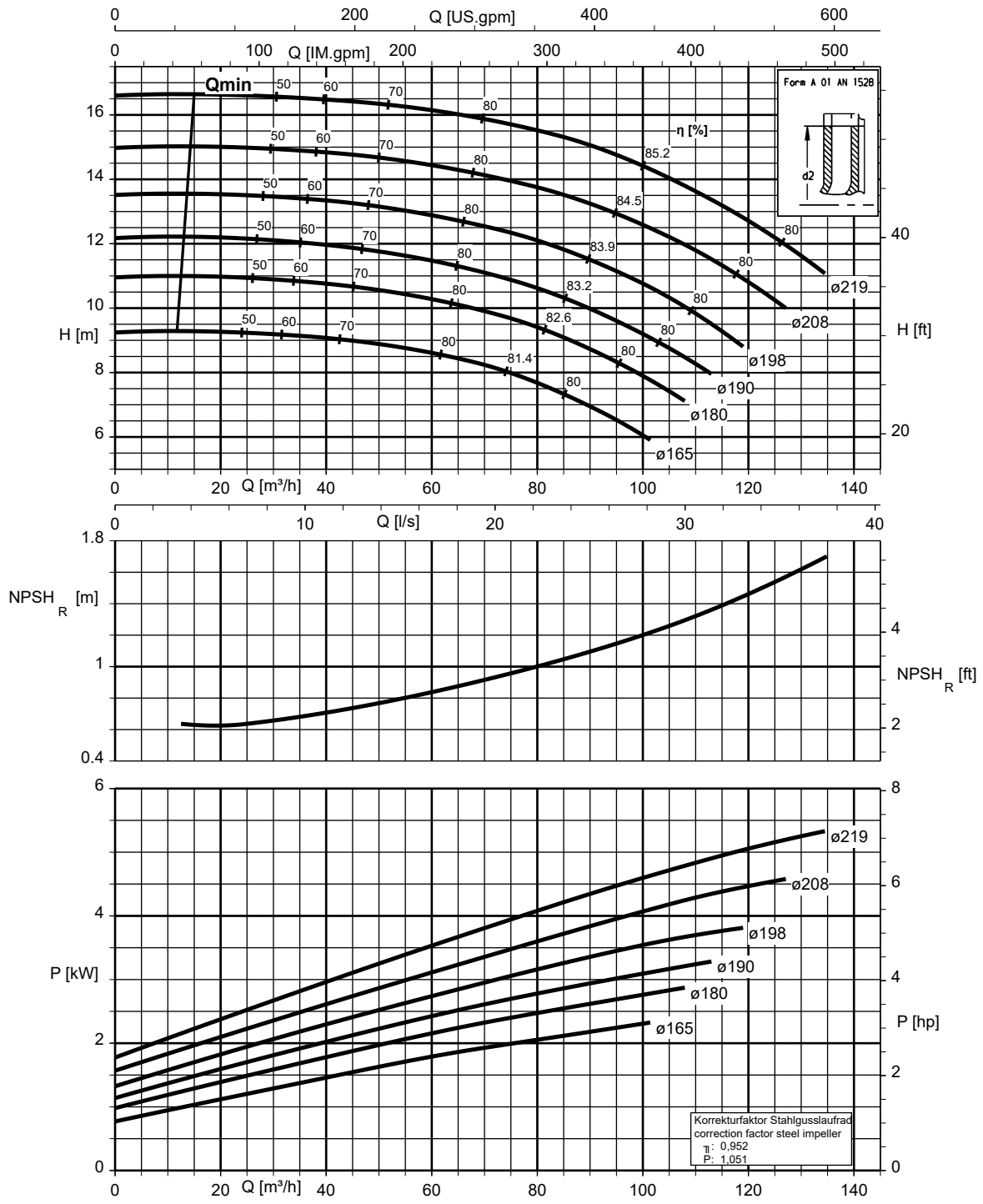

Vlet , Velta 100-080-250, n = 1450 rpm

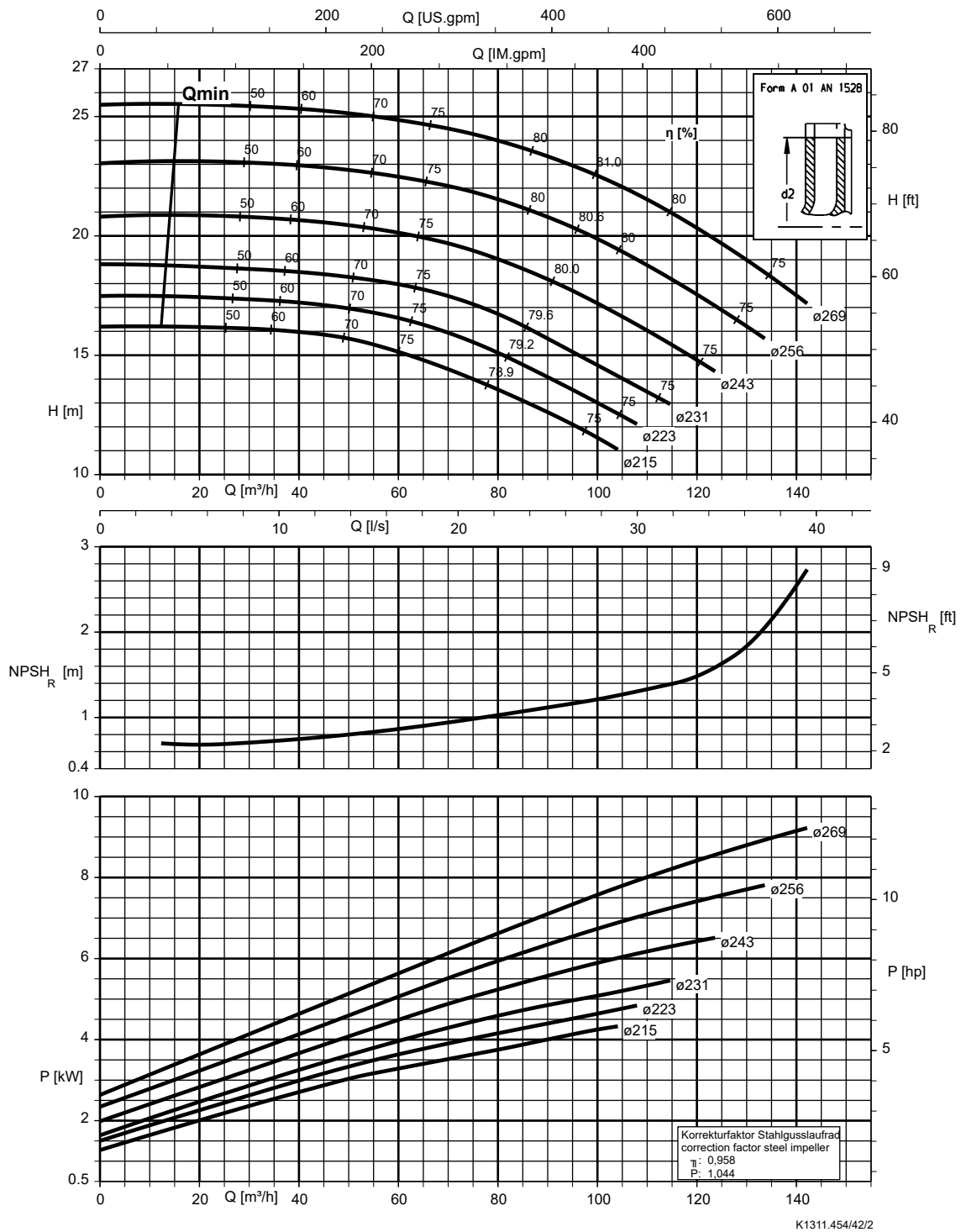

Vlet , Velta 100-080-315, n = 1450 rpm

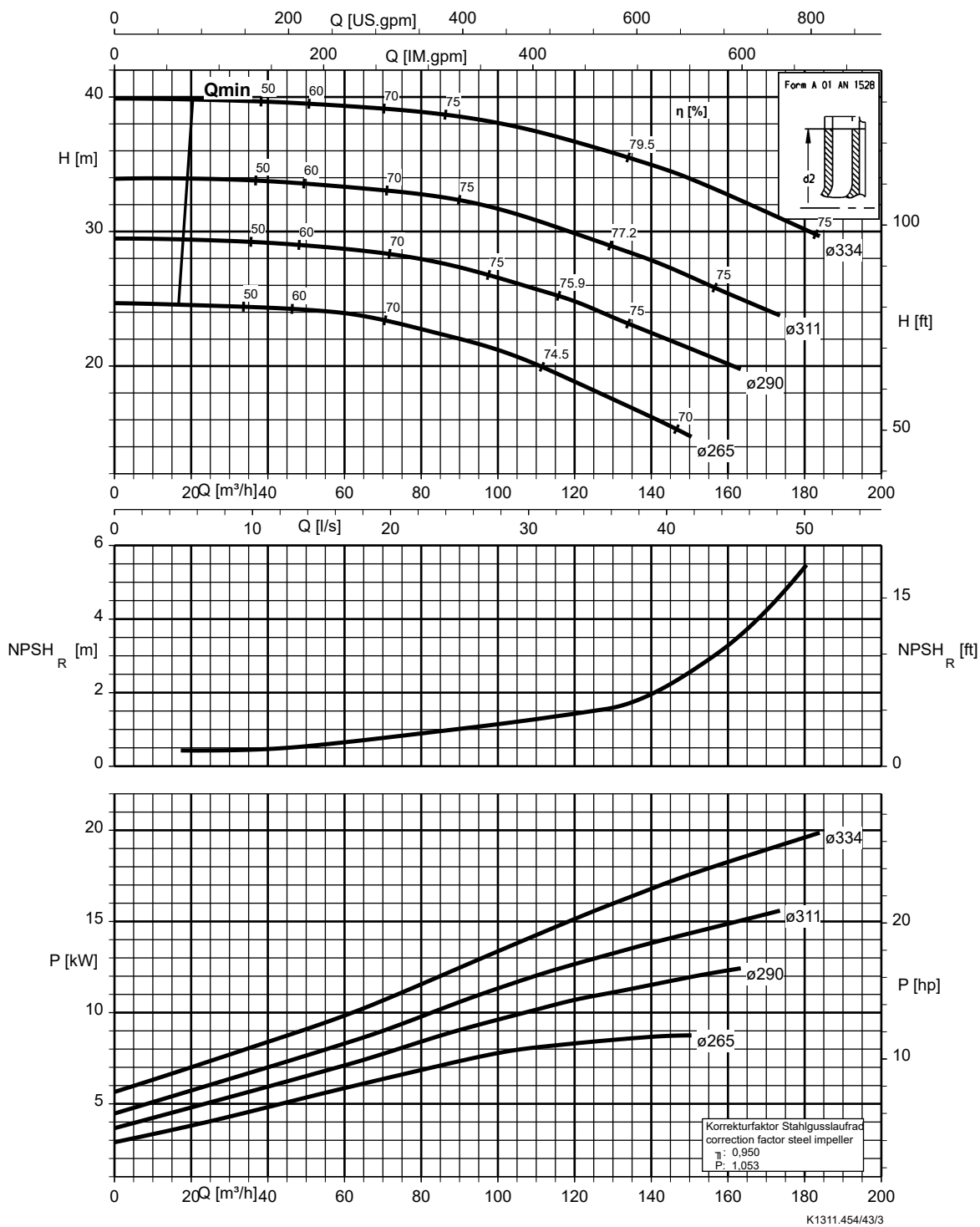

Vlet , Velta 100-080-400, n = 1450 rpm

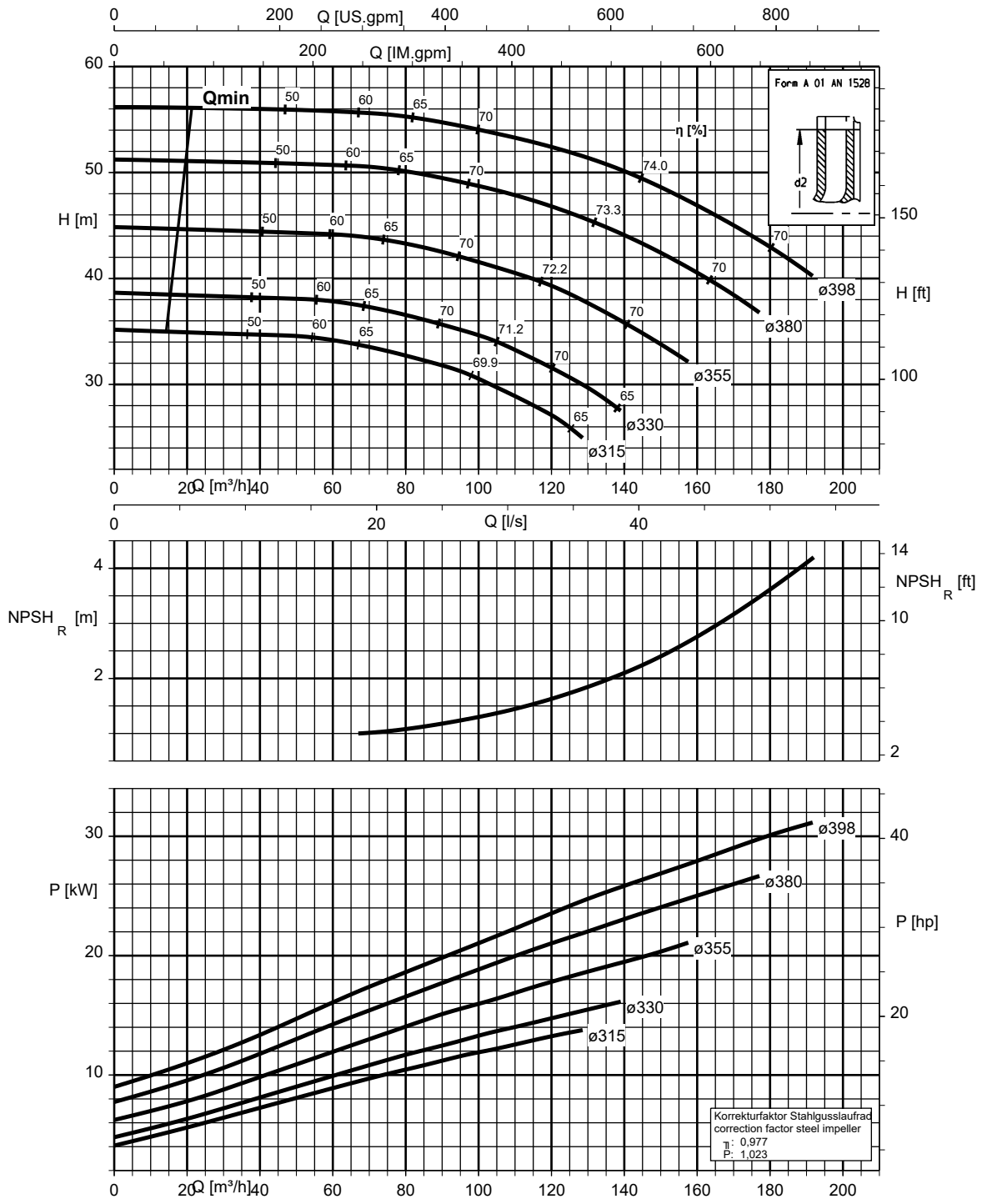

Vlet , Velta 125-100-160, n = 1450 rpm

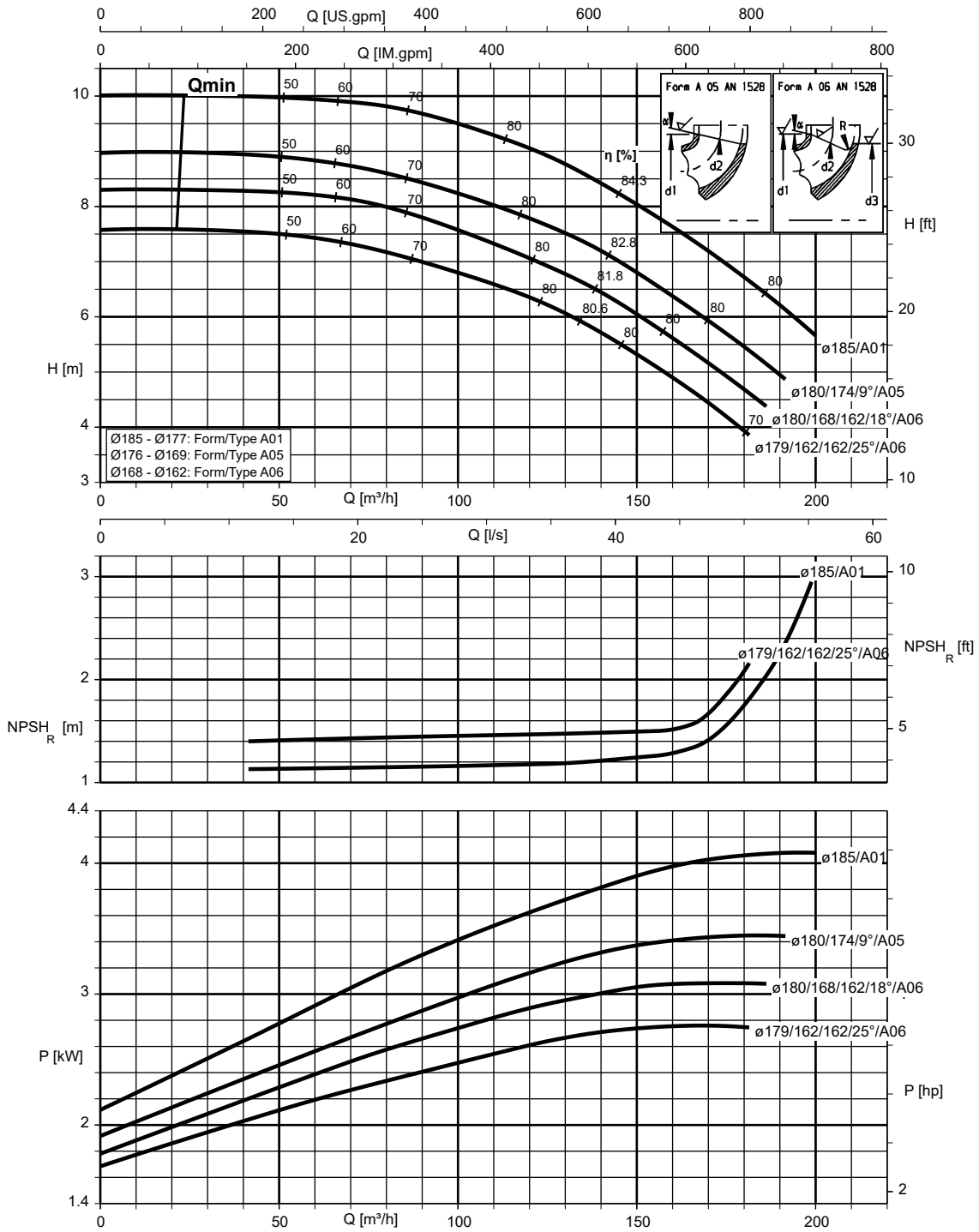

K1311.454/45/2

Vlet , Velta 125-100-200, n = 1450 rpm

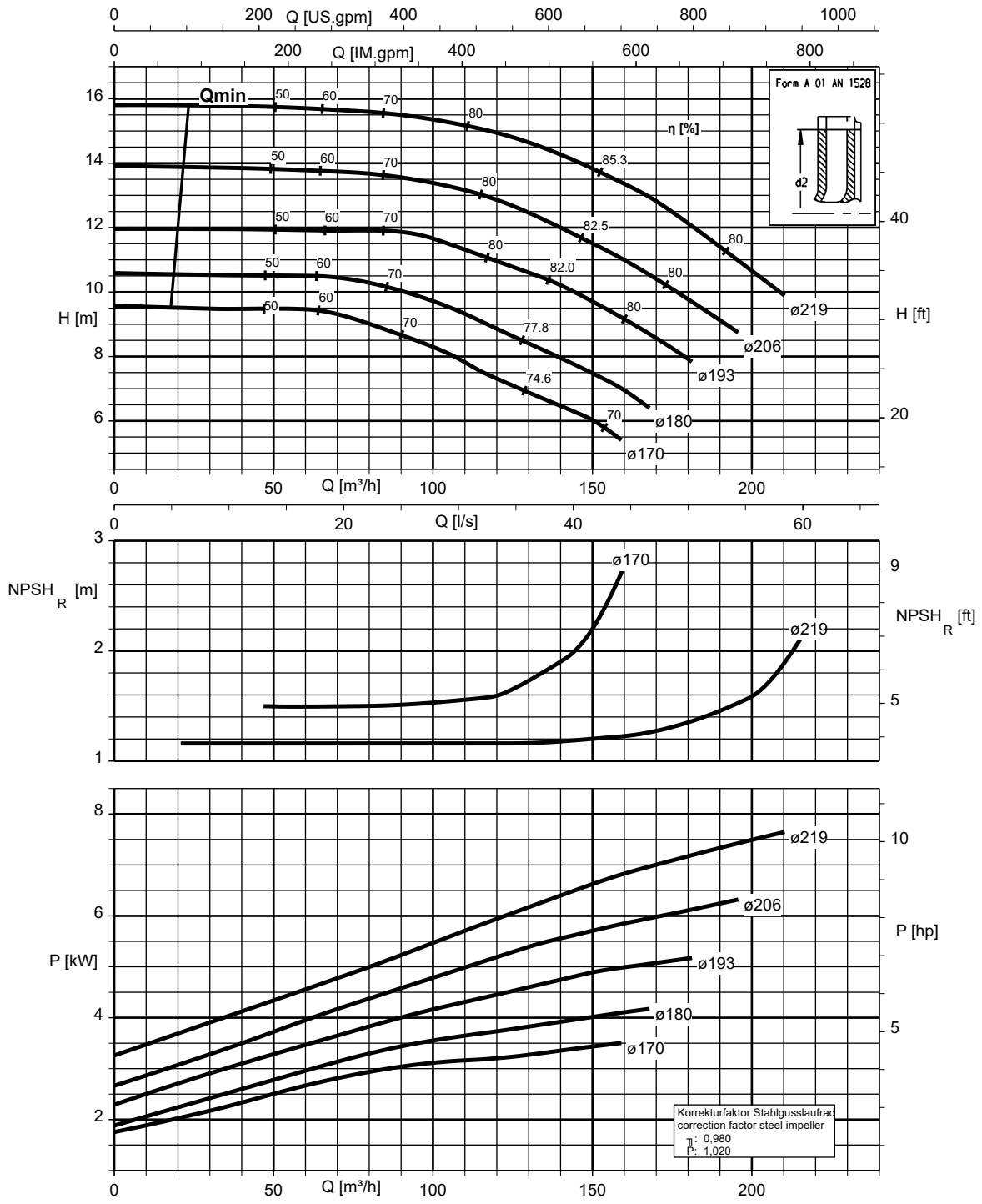



Vlet , Velta 125-100-250, n = 1450 rpm

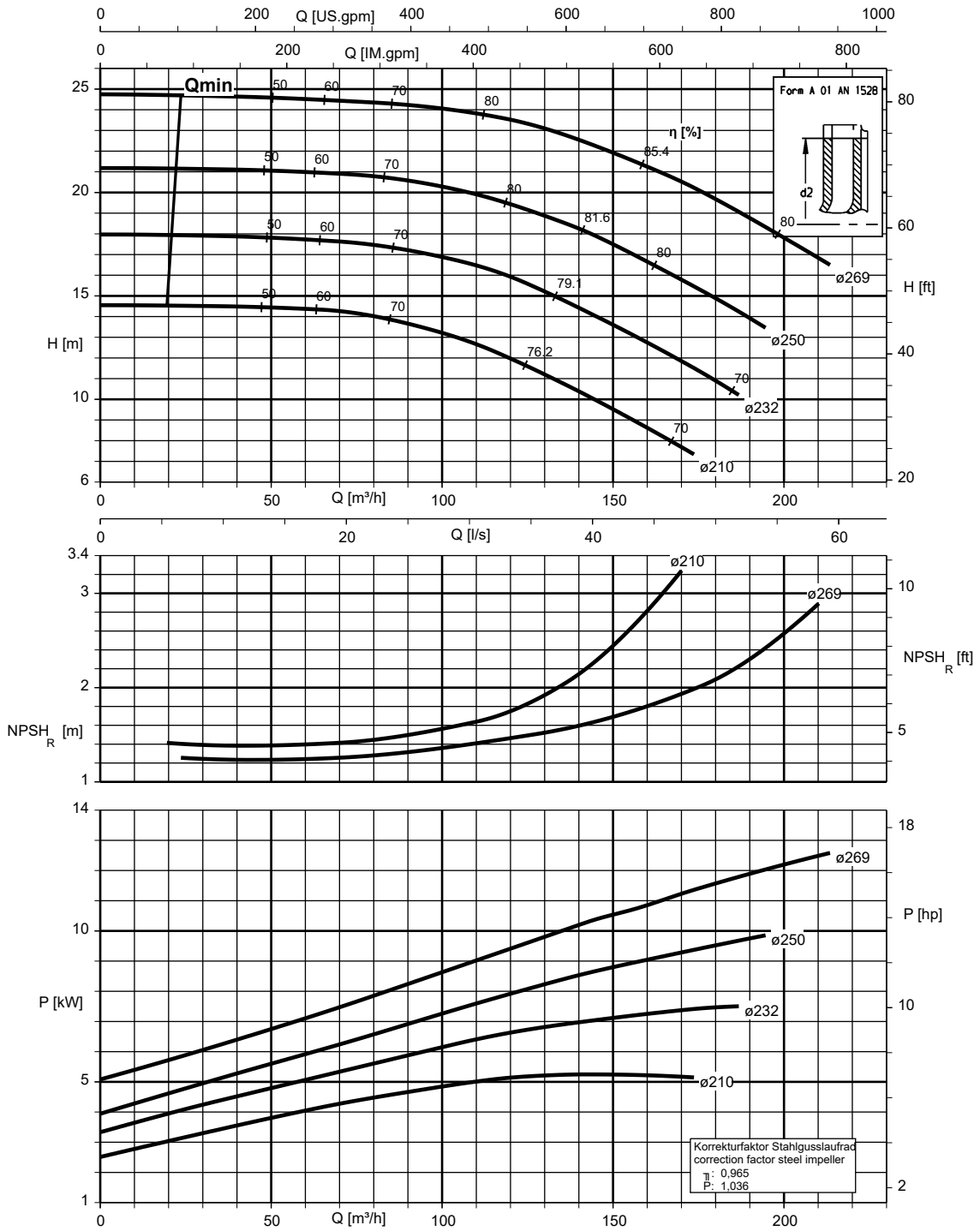

K1311.454/47/2

Vlet , Velta 125-100-315, n = 1450 rpm

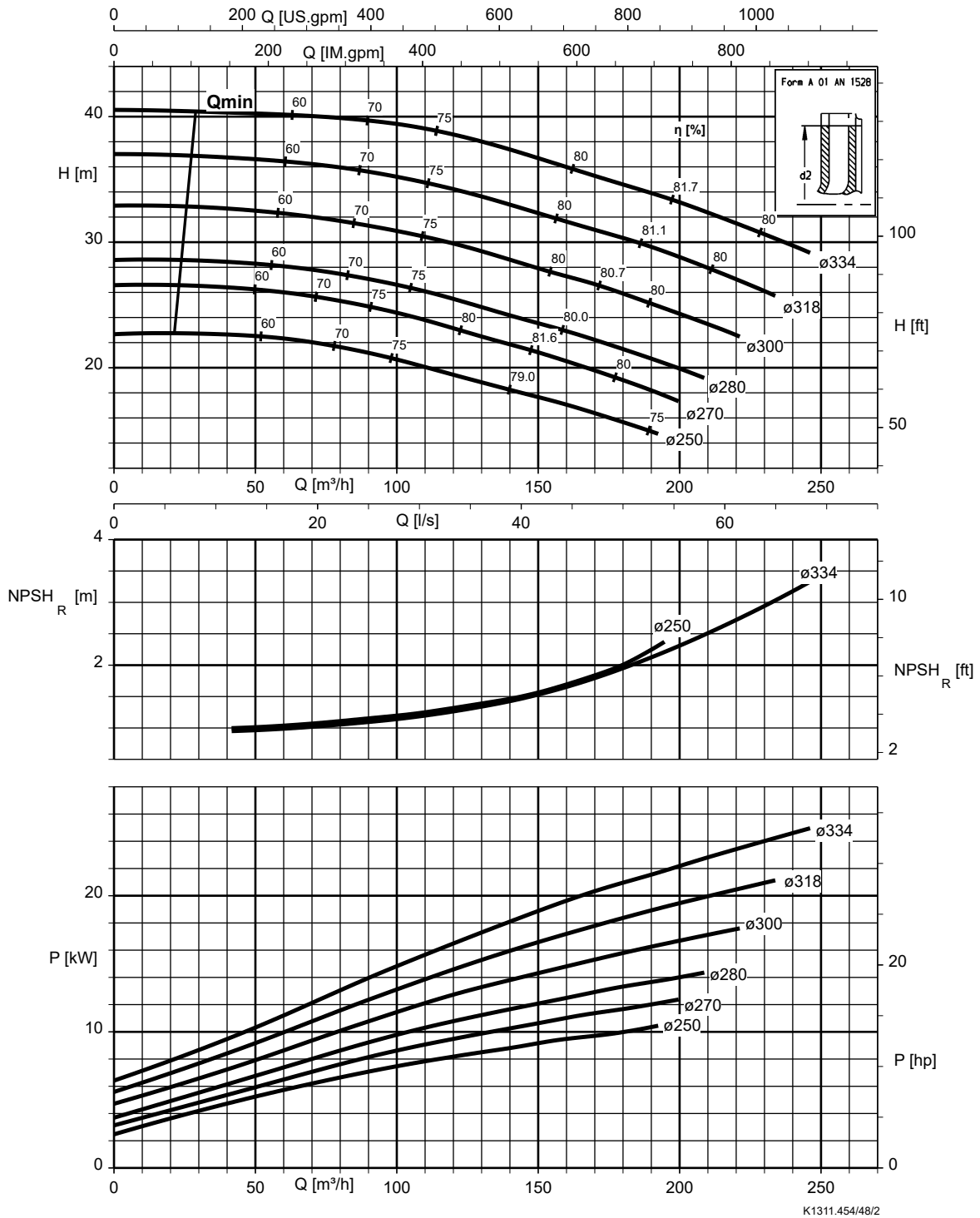

Vlet , Velta 125-100-400, n = 1450 rpm

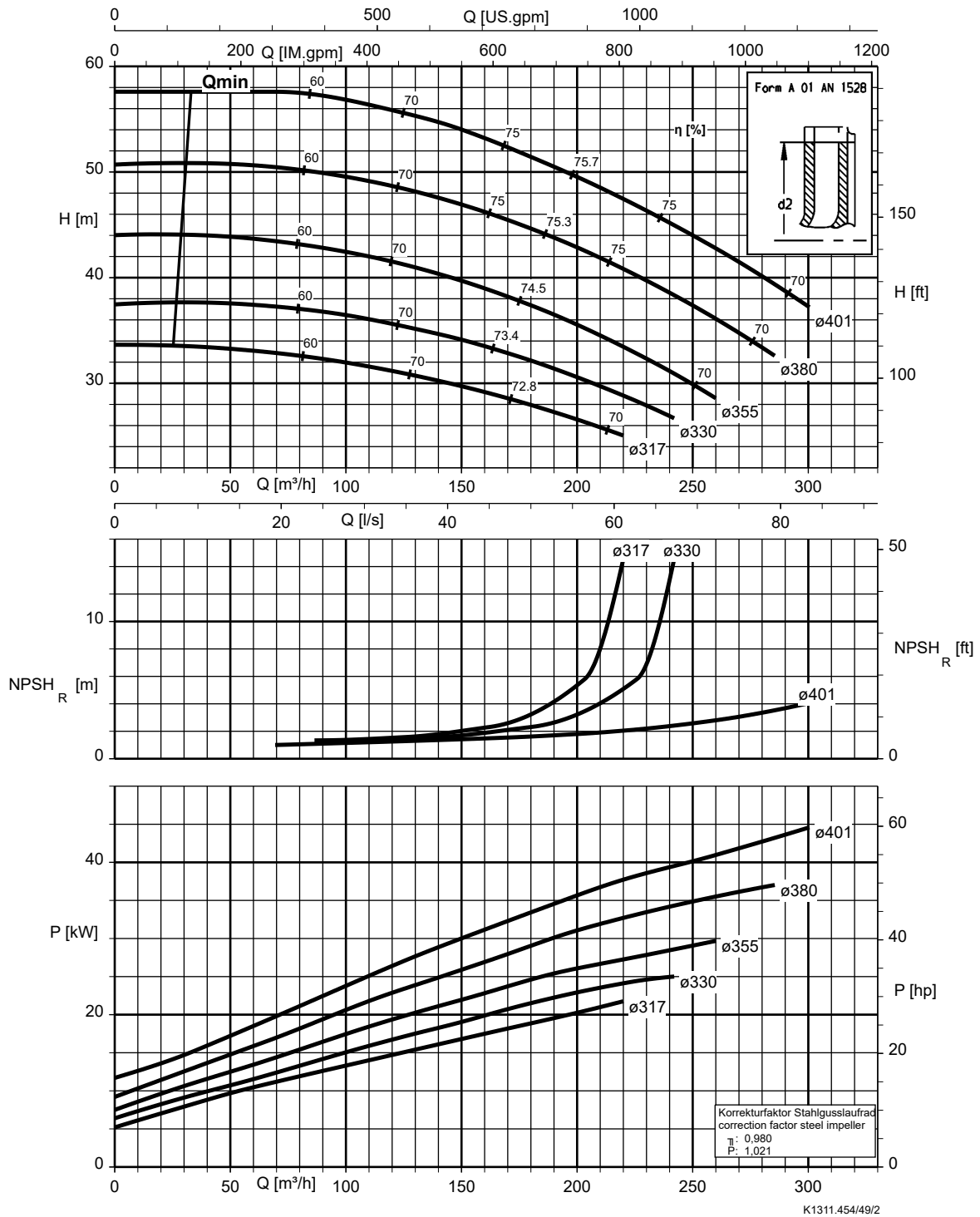

Vlet , Velta 150-125-200, n = 1450 rpm

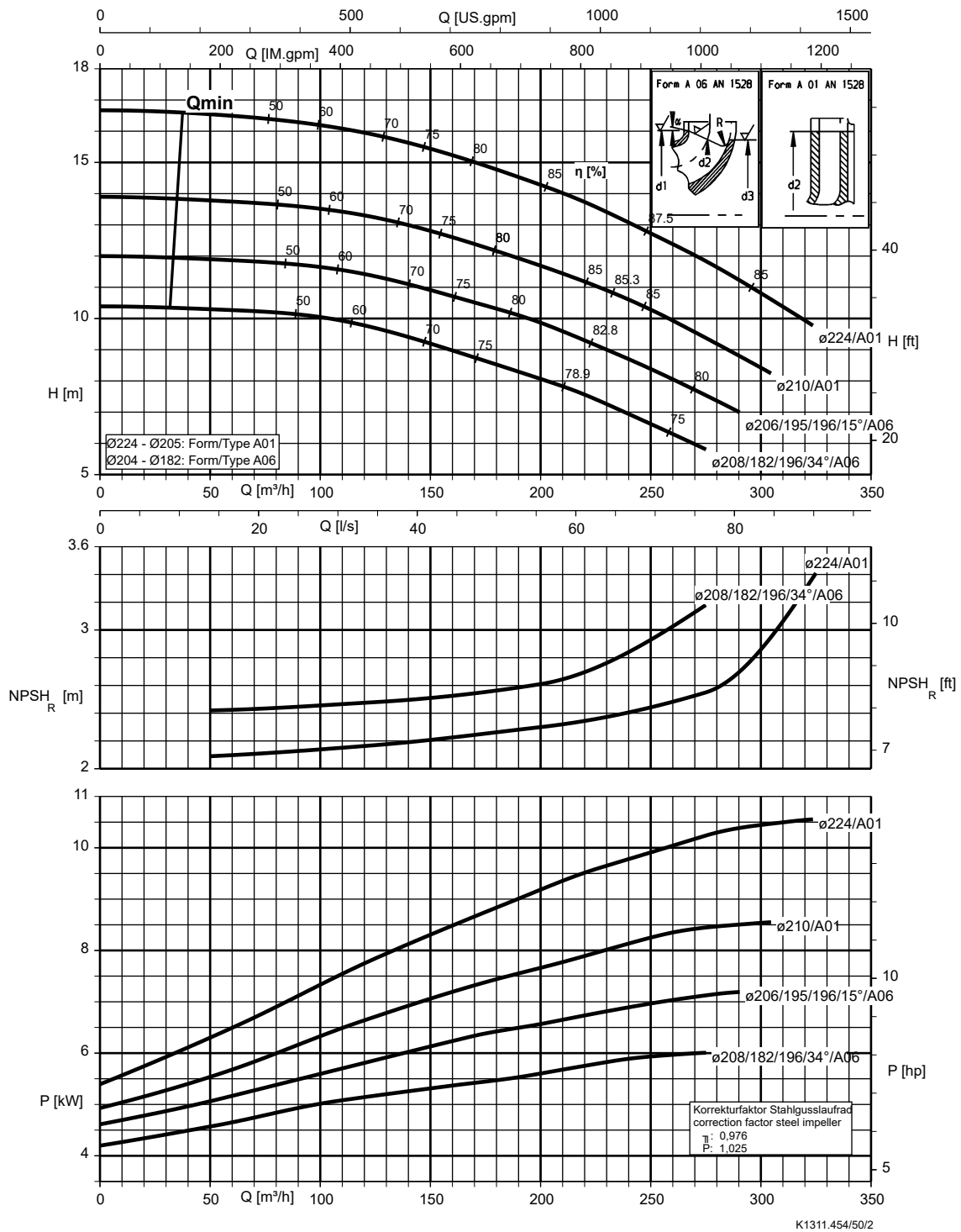

Vlet, Velta 150-125-250, n = 1450 rpm

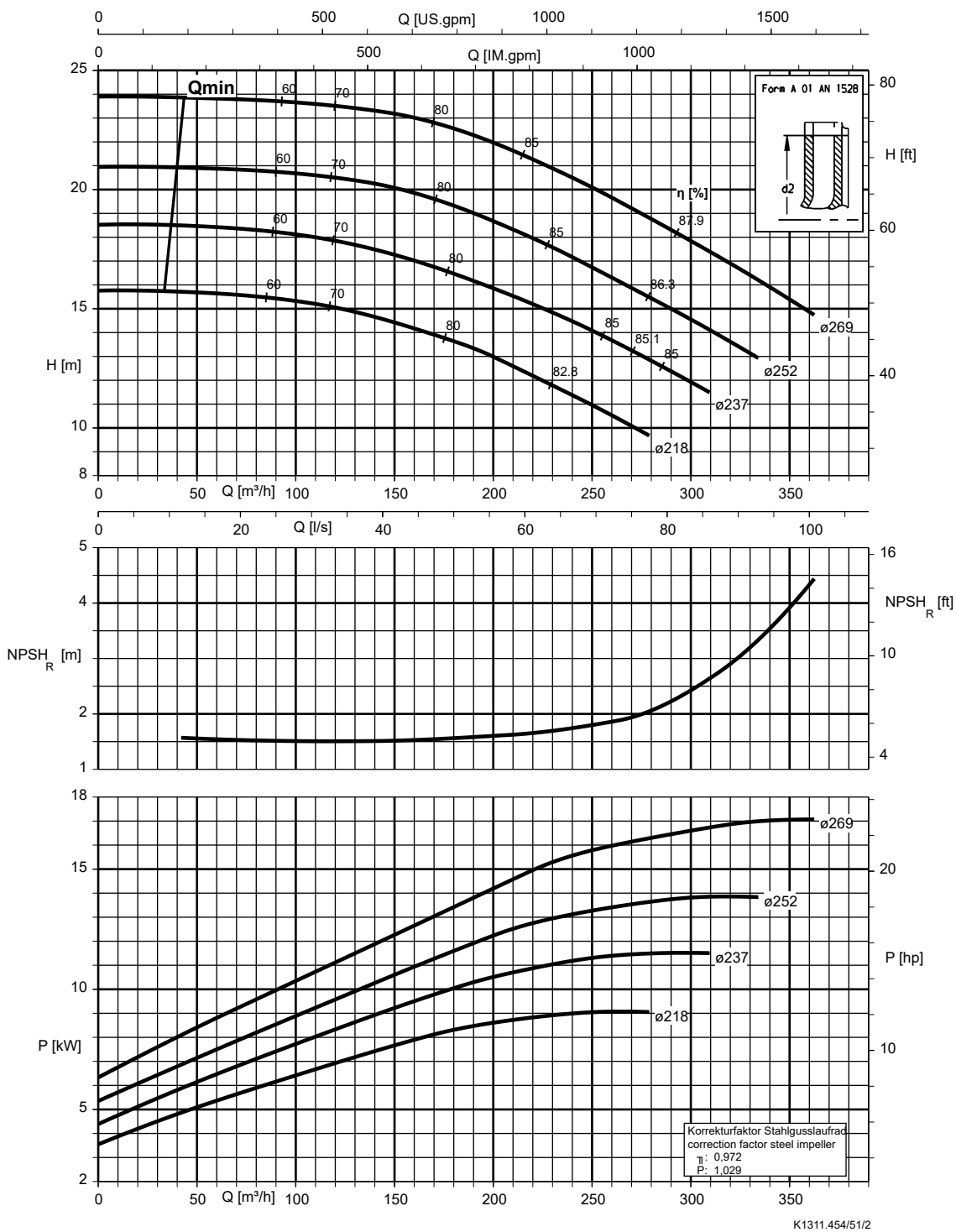

Vlet , Velta 150-125-315, n = 1450 rpm

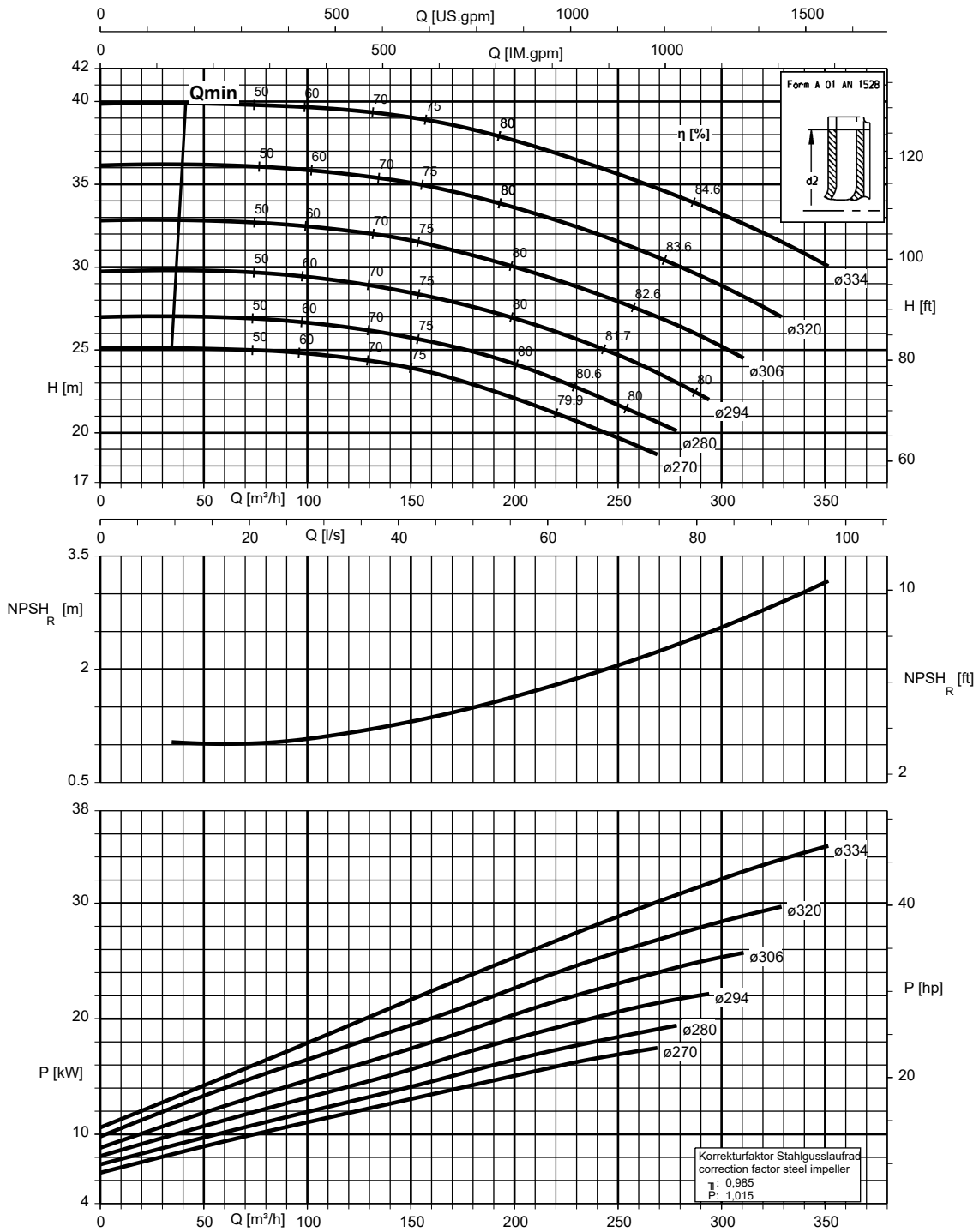

K1311.454/52/2

Vlet , Velta 150-125-400, n = 1450 rpm

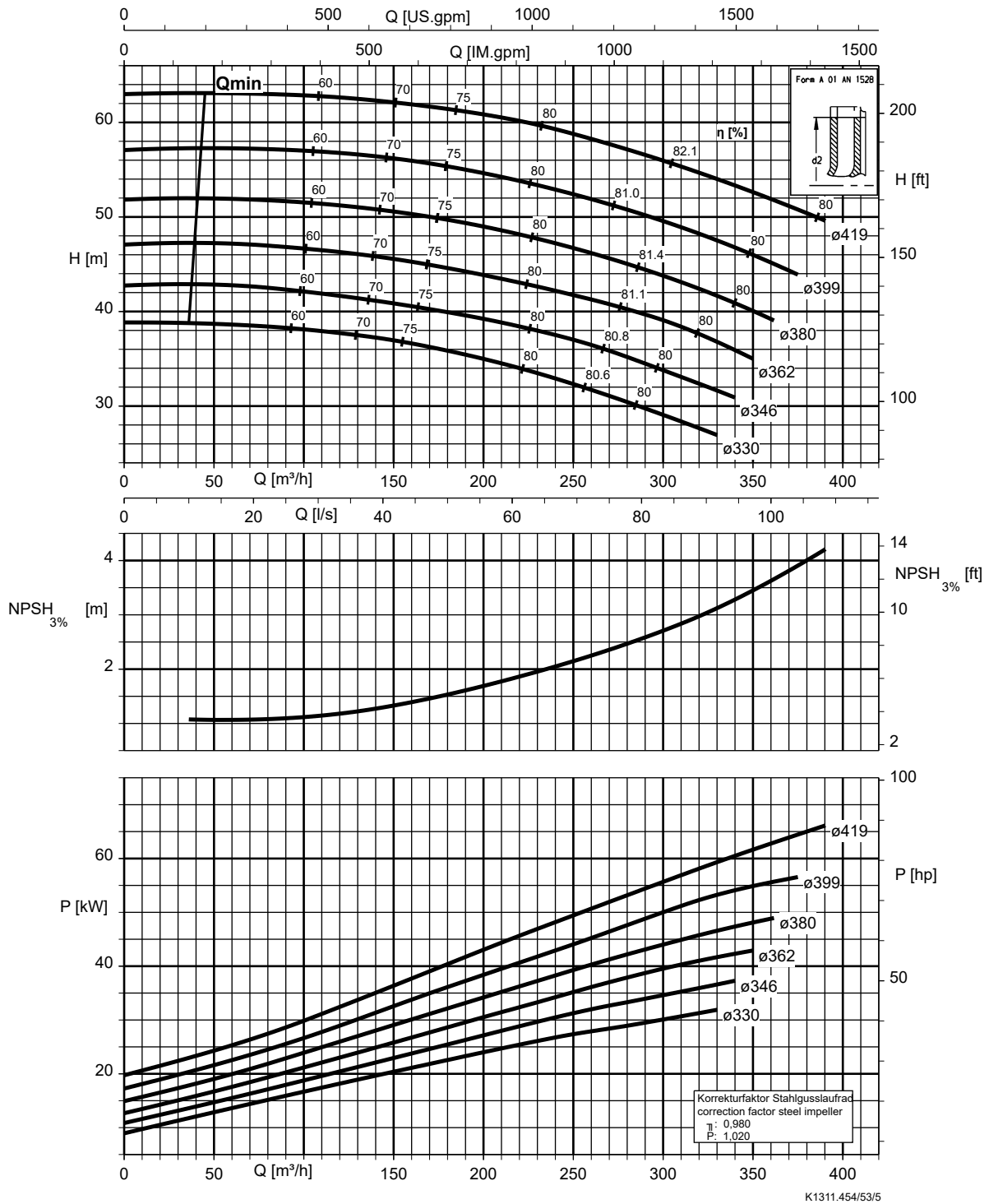

Vlet , Velta 150-125-510, n = 1450 rpm

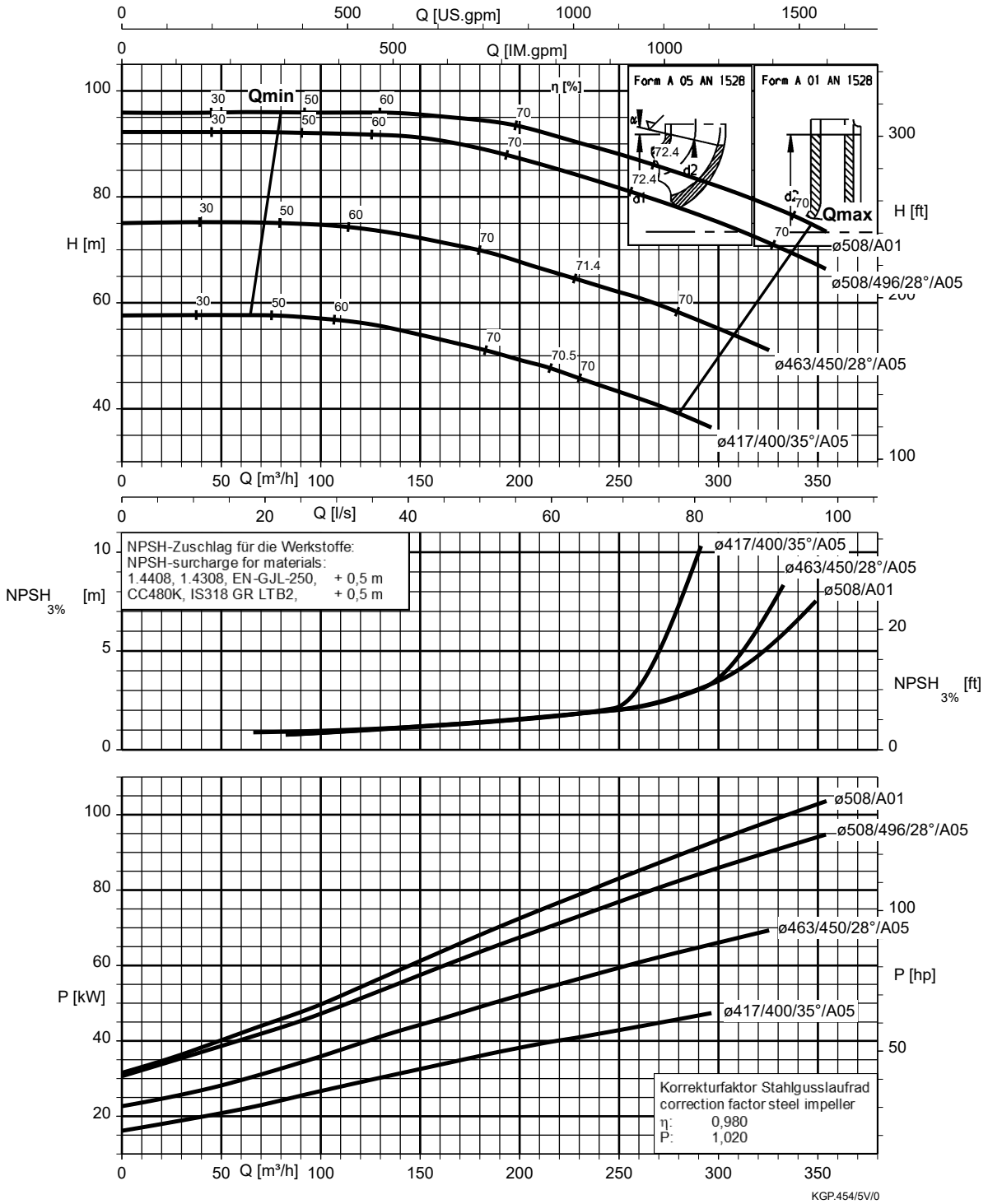



Vlet , Velta 200-150-200, n = 1450 rpm

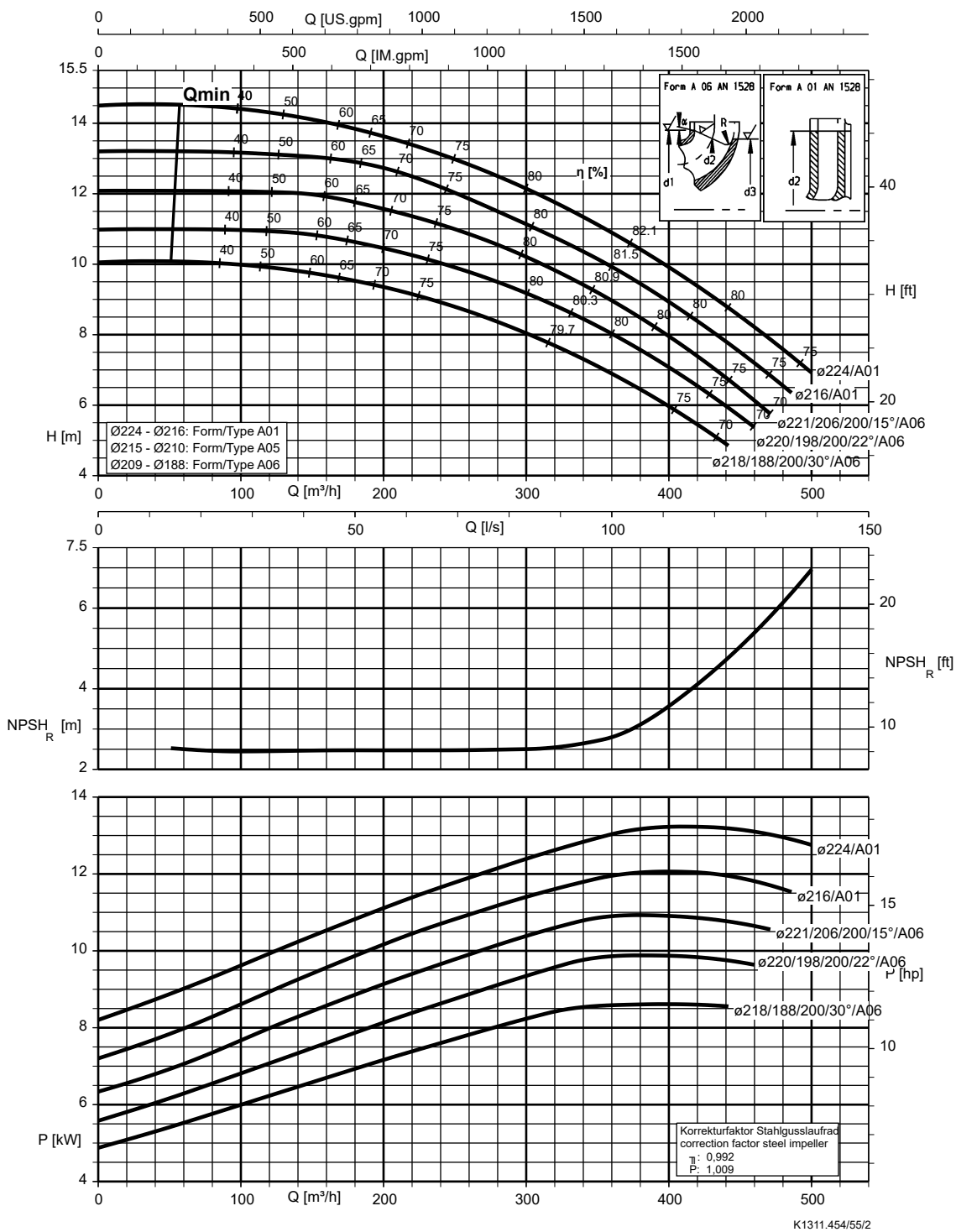

Vlet , Velta 200-150-250, n = 1450 rpm

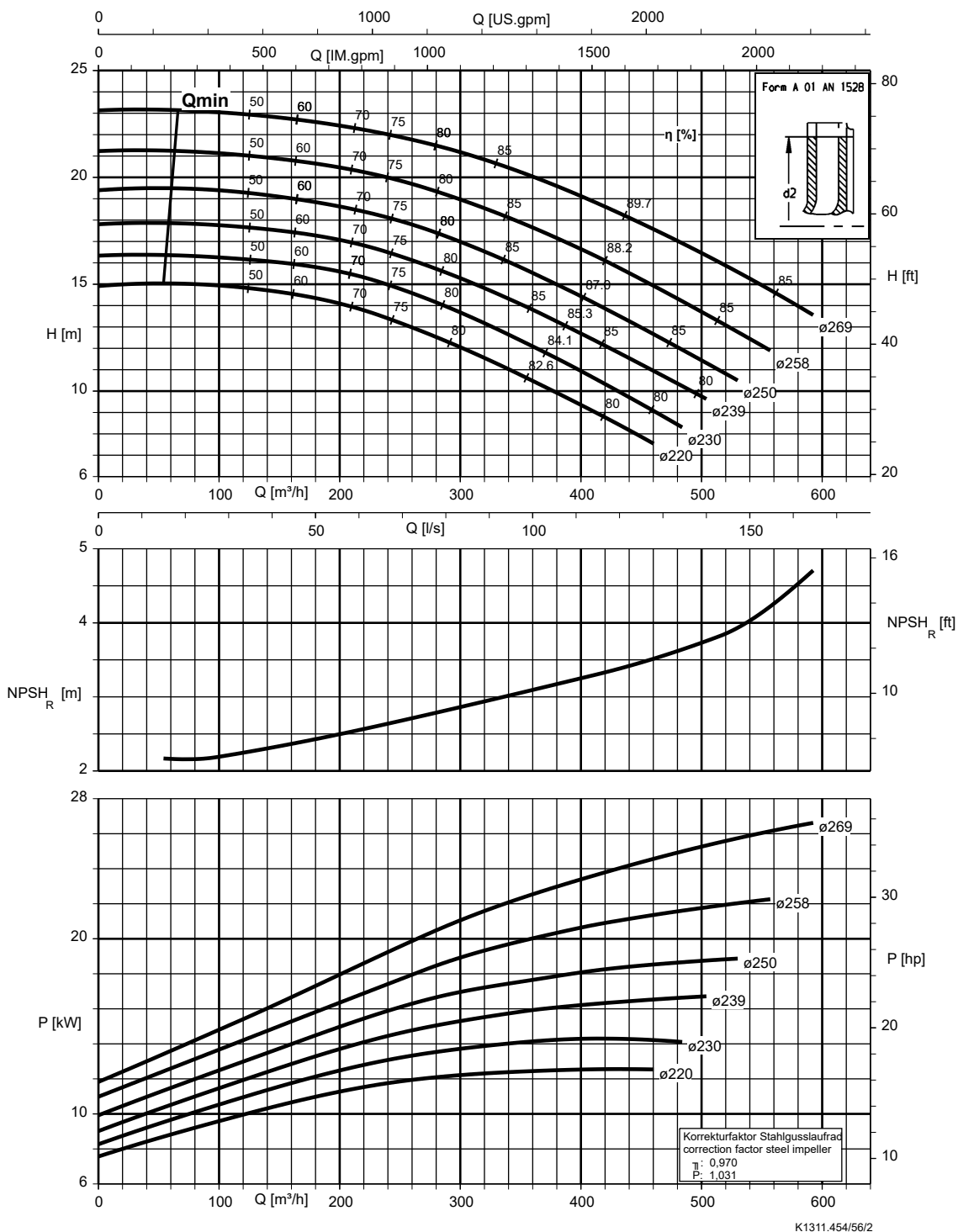

Vlet , Velta 200-150-315, n = 1450 rpm

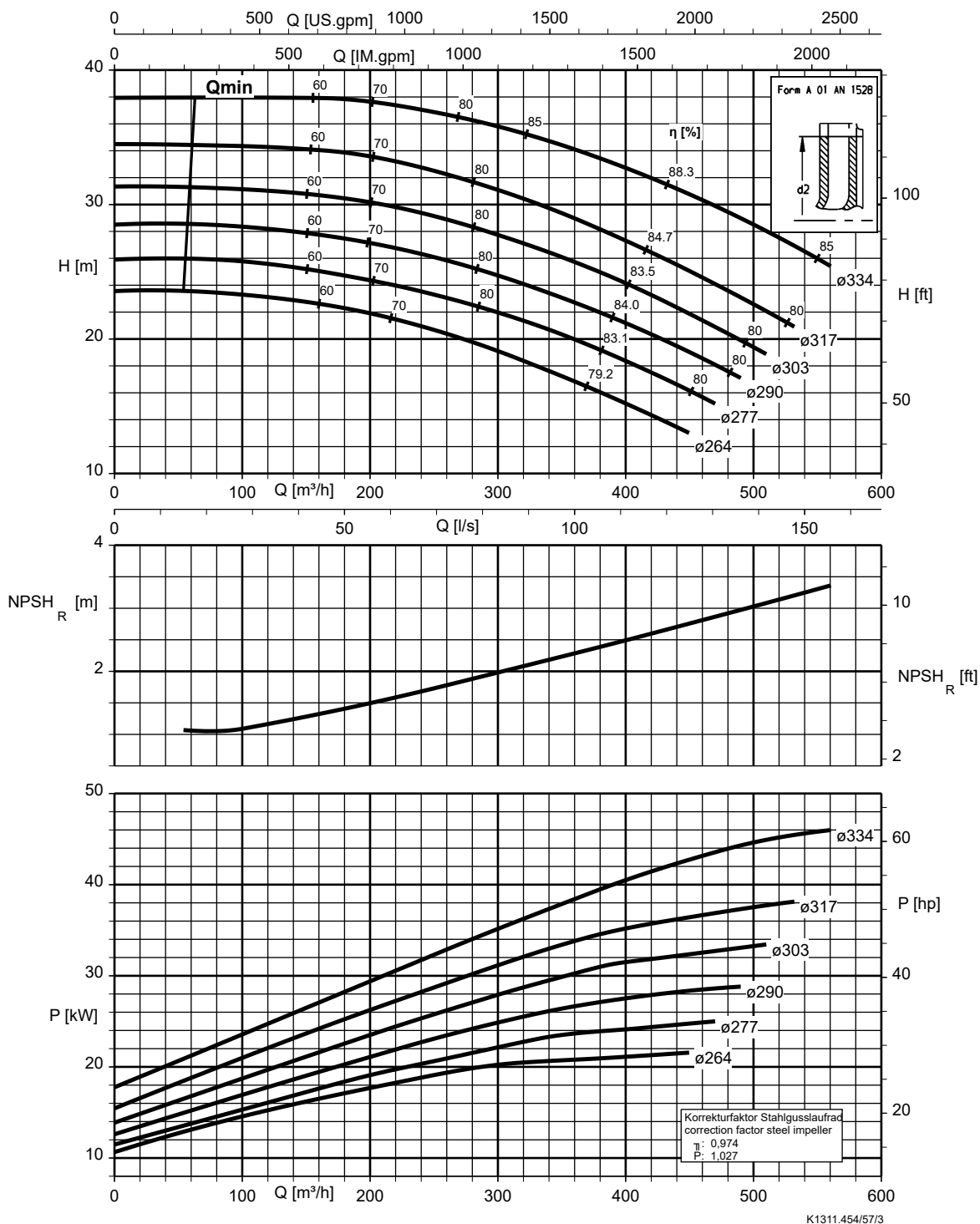

Vlet , Velta 200-150-400, n = 1450 rpm

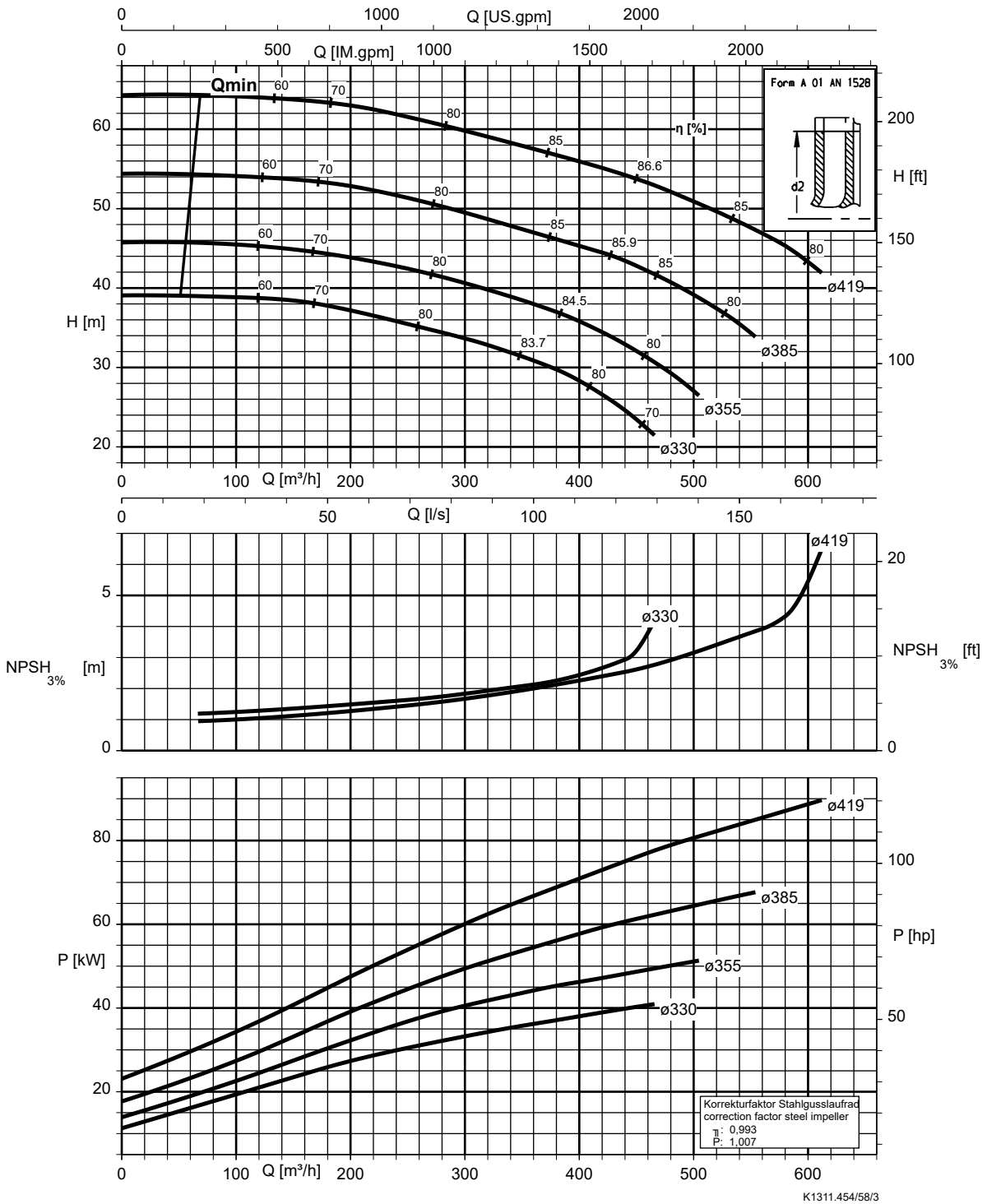

Vlet , Velta 200-150-510, n = 1450 rpm

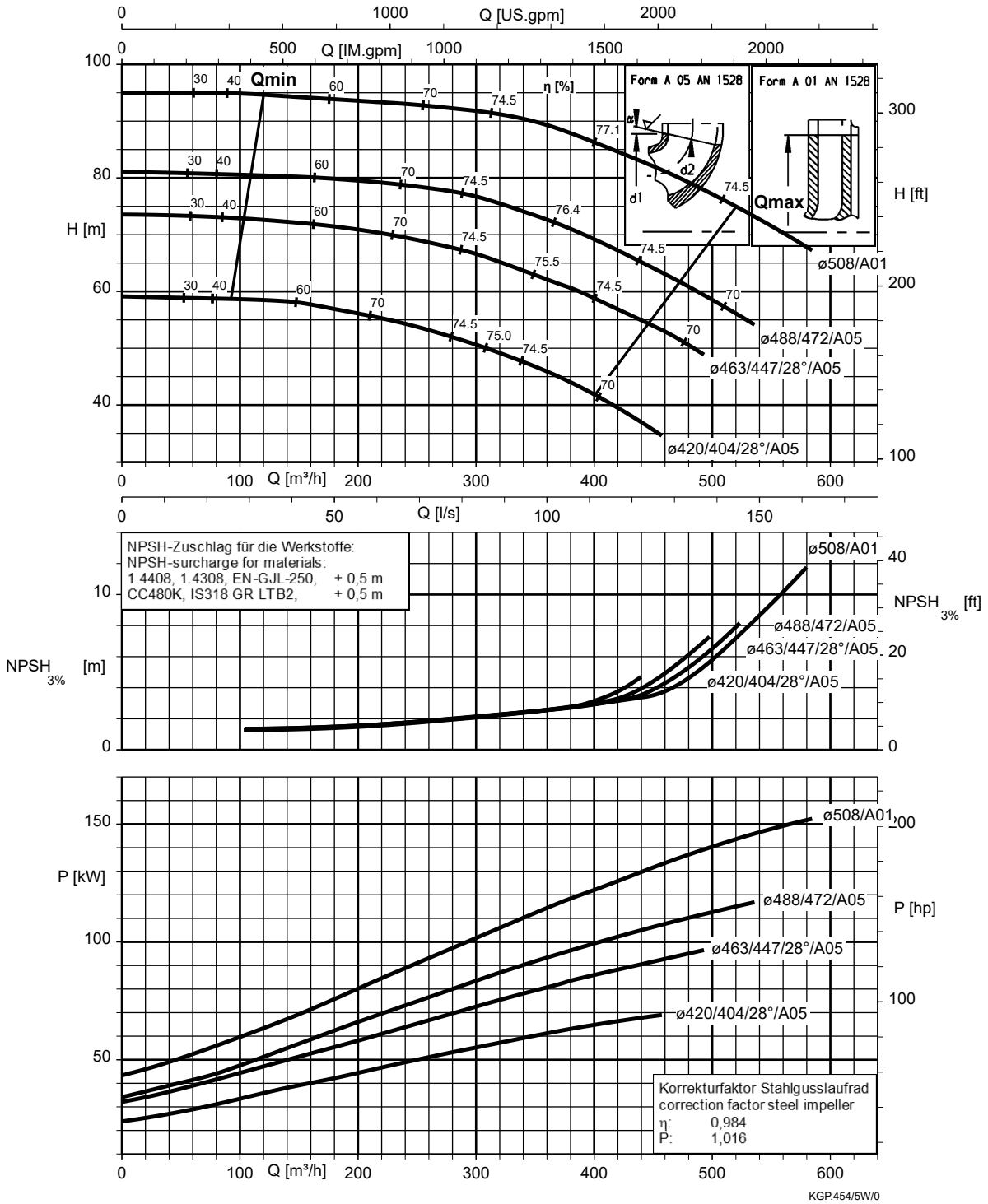

Vlet , Velta 200-200-250, n = 1450 rpm

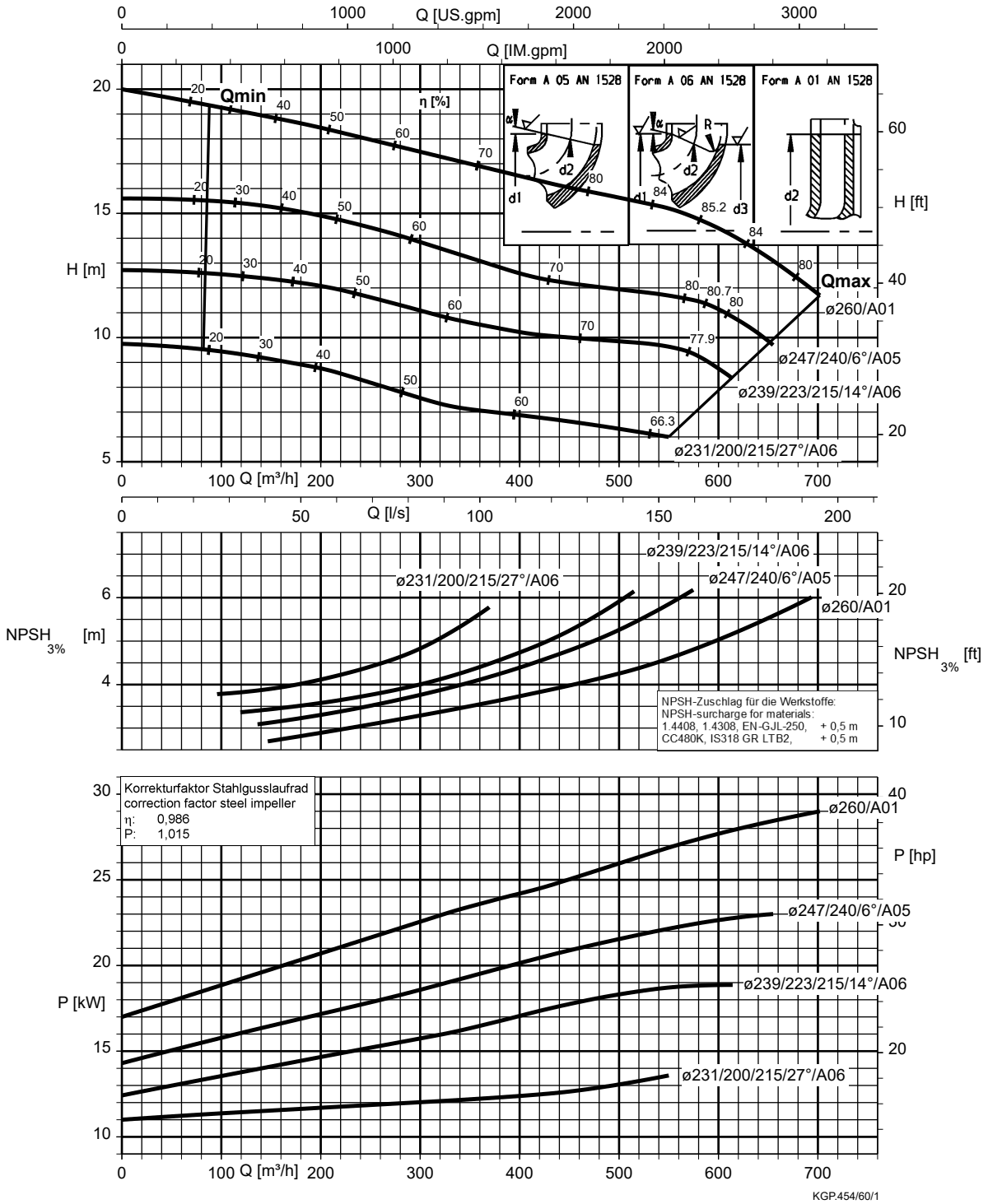

Vlet , Velta 250-200-275, n = 1450 rpm

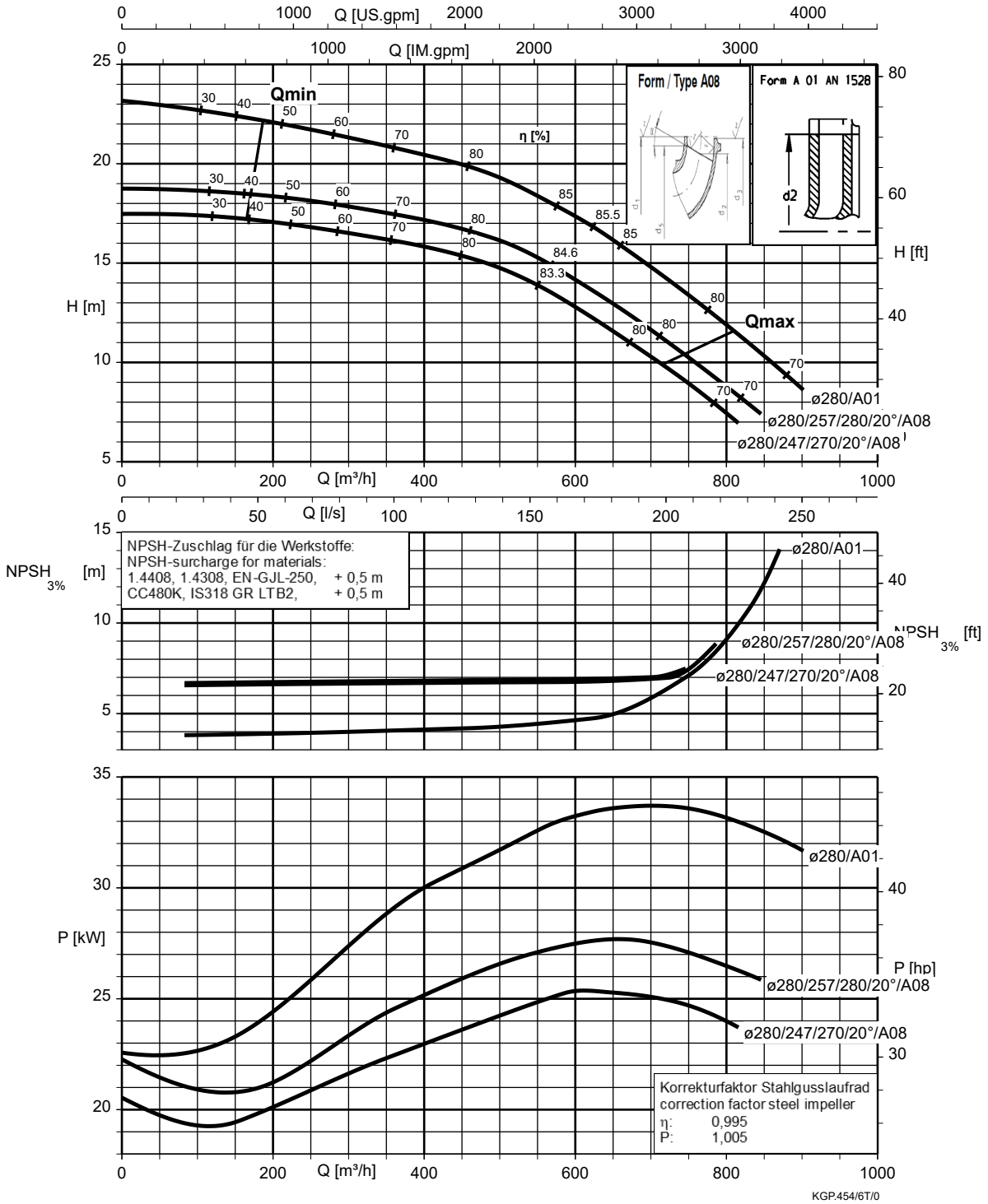

Vlet , Velta 250-200-320, n = 1450 rpm

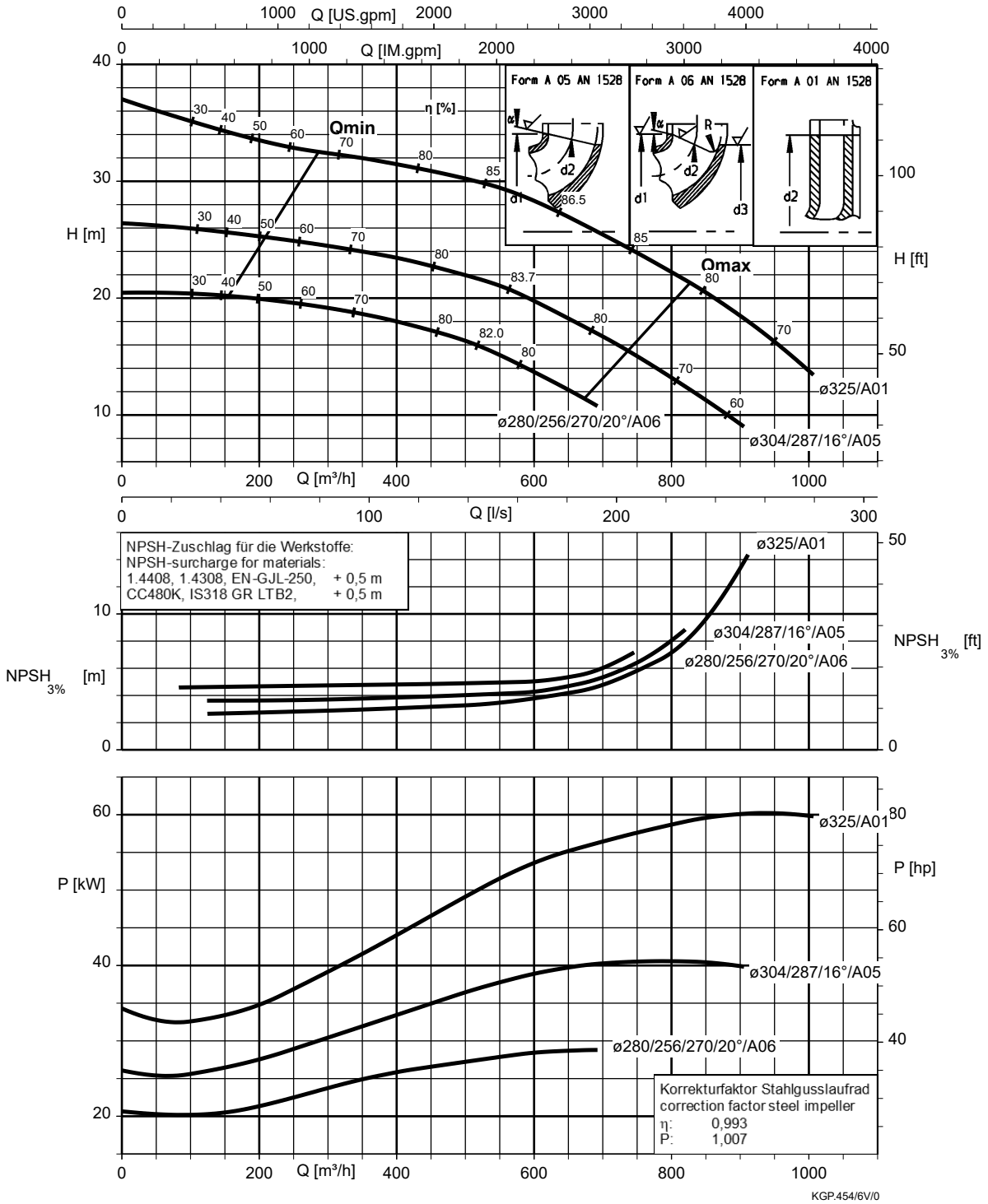



Vlet , Velta 250-200-375, n = 1450 rpm

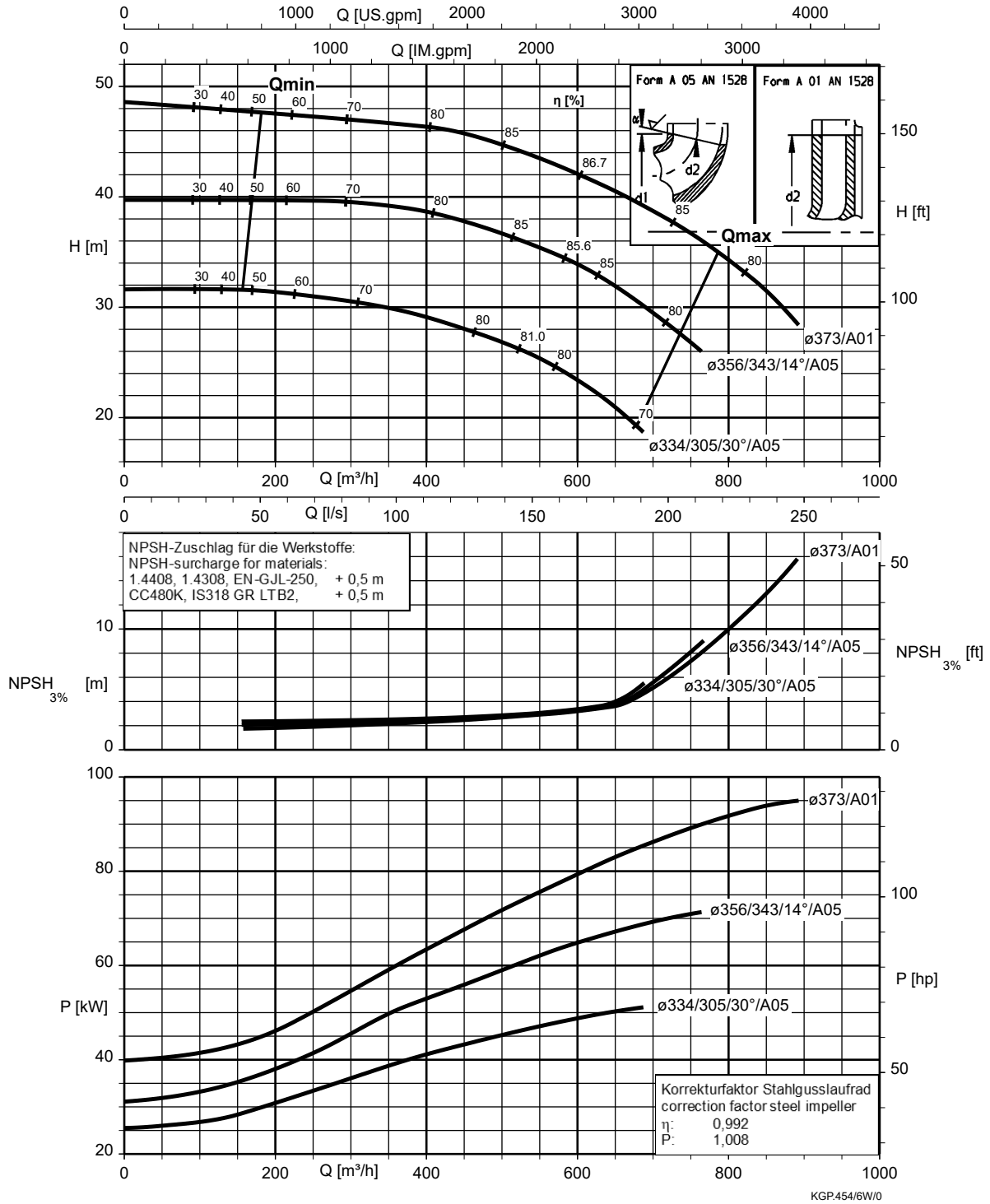

Vlet , Velta 250-200-435 , n = 1450 rpm

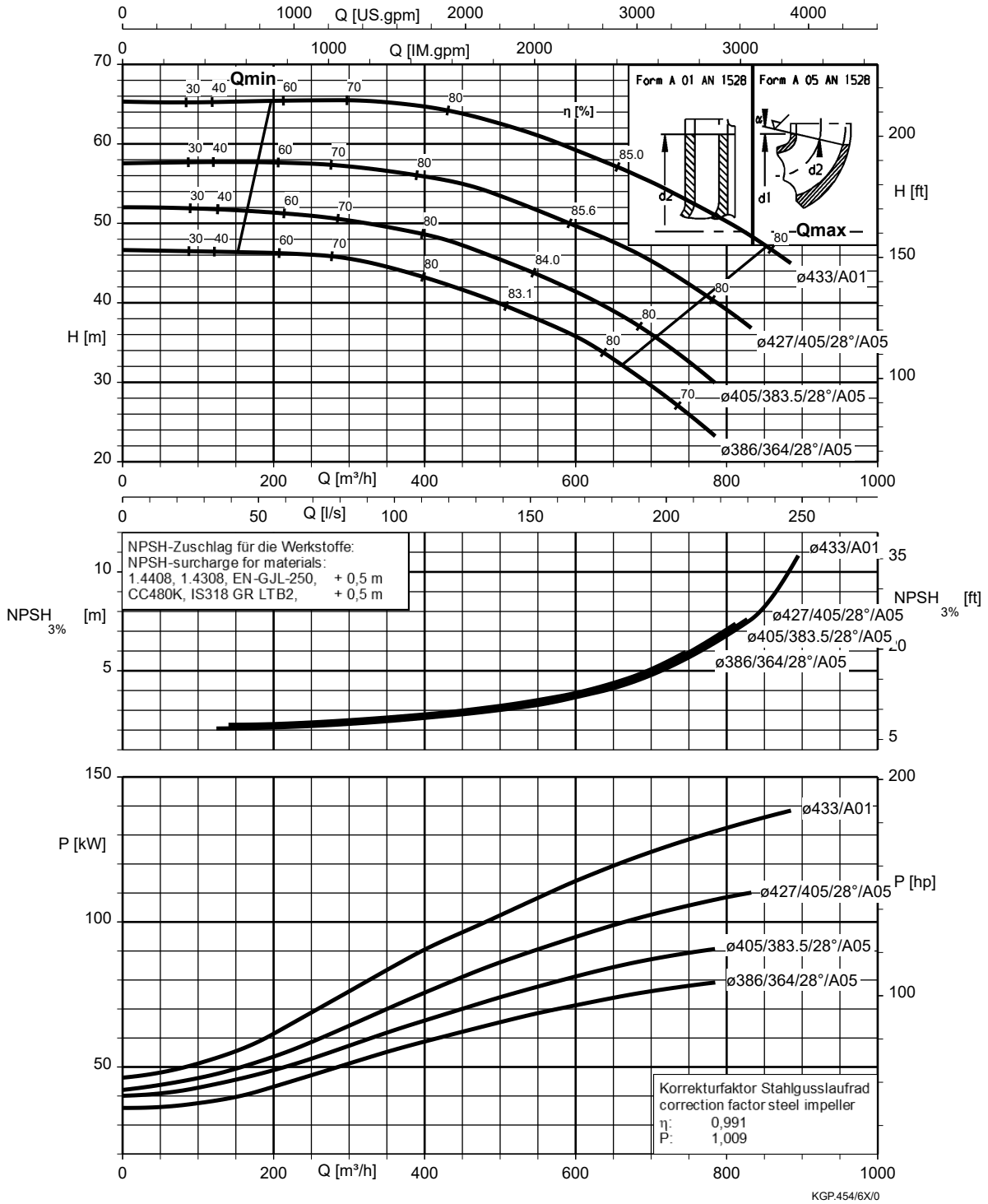

Vlet , Velta 250-200-510 , n = 1450 rpm

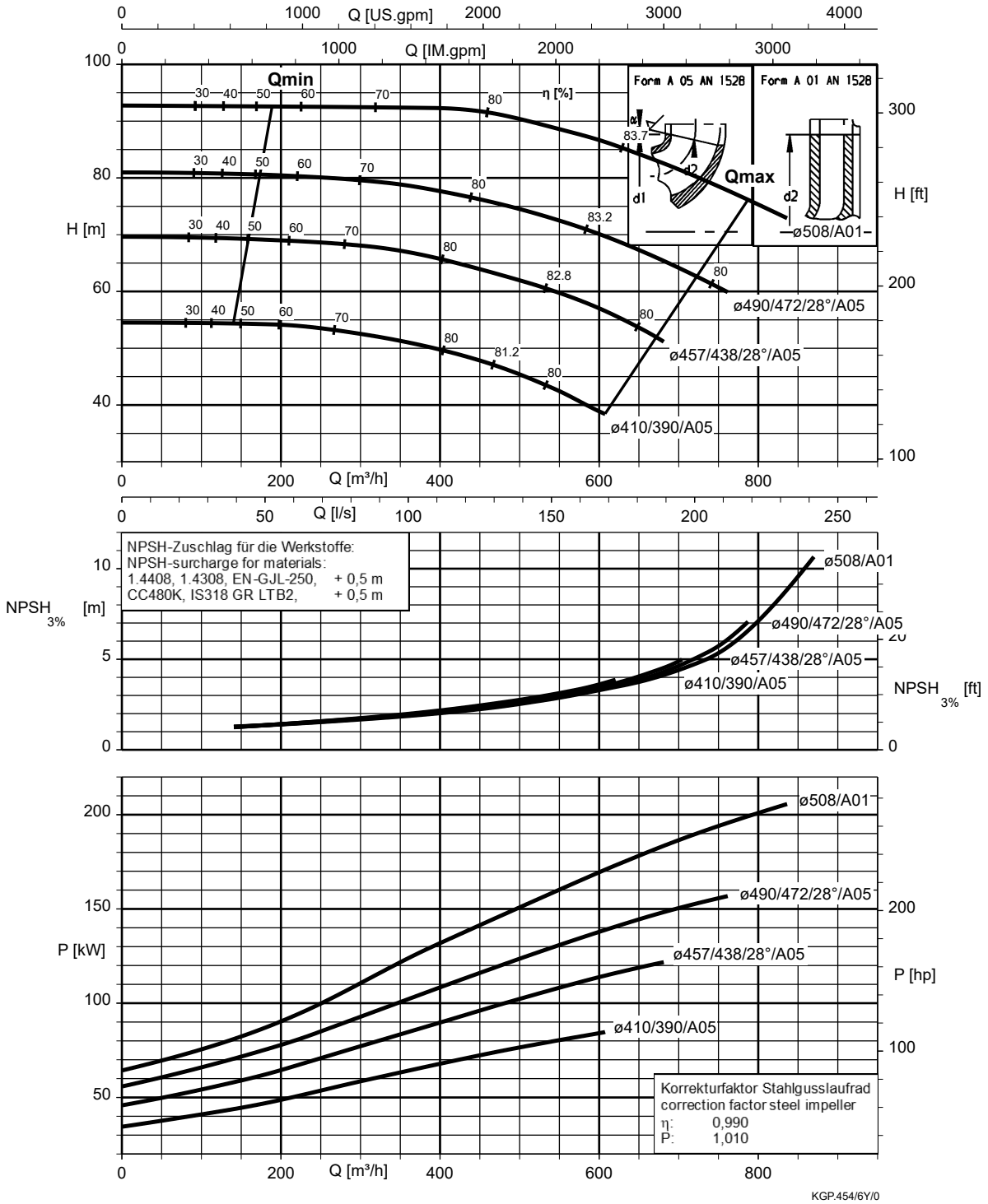

Vlet, Velta 300-250-295, n = 1450 rpm

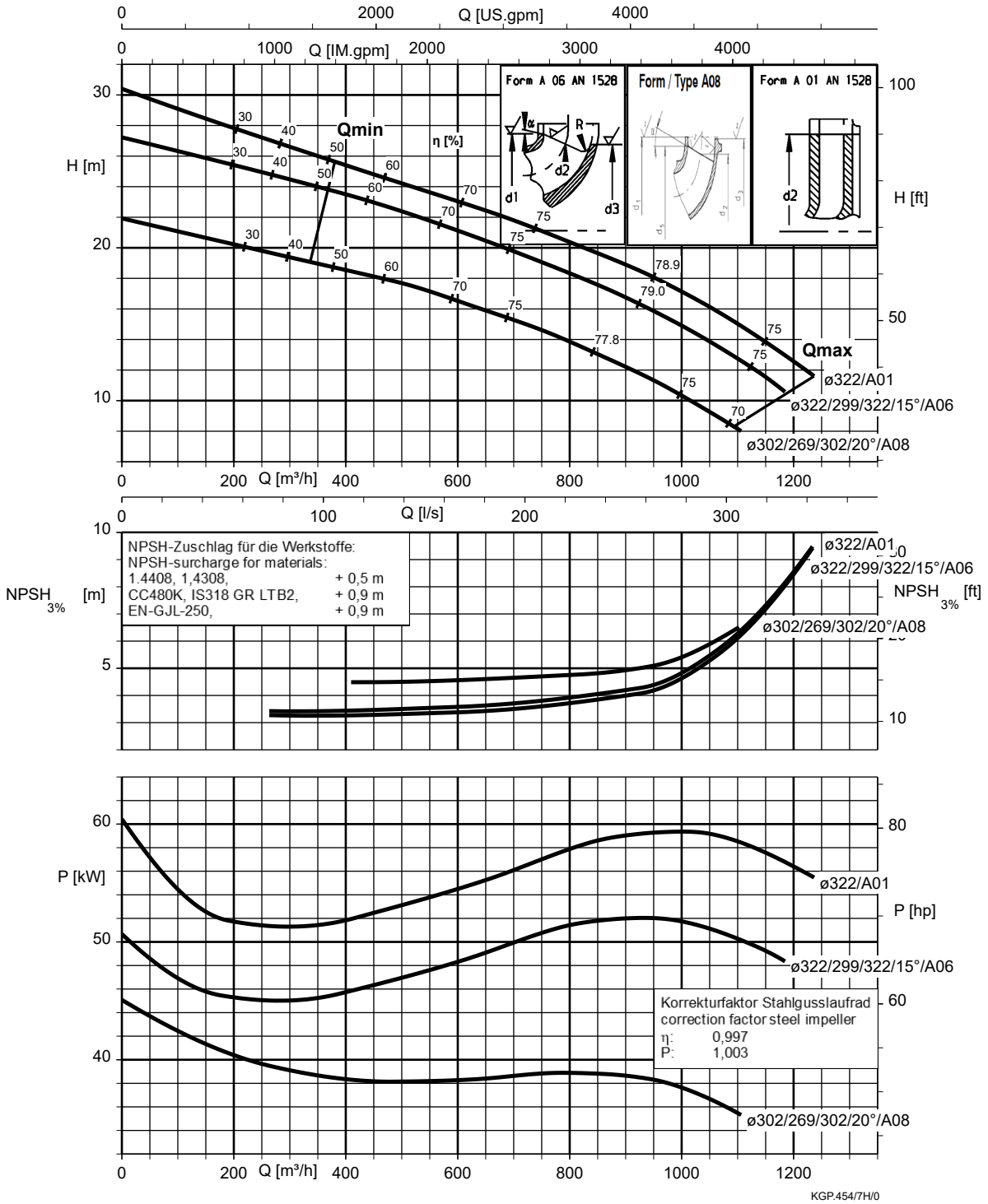

Vlet , Velta 300-250-295.1 , n = 1450 rpm

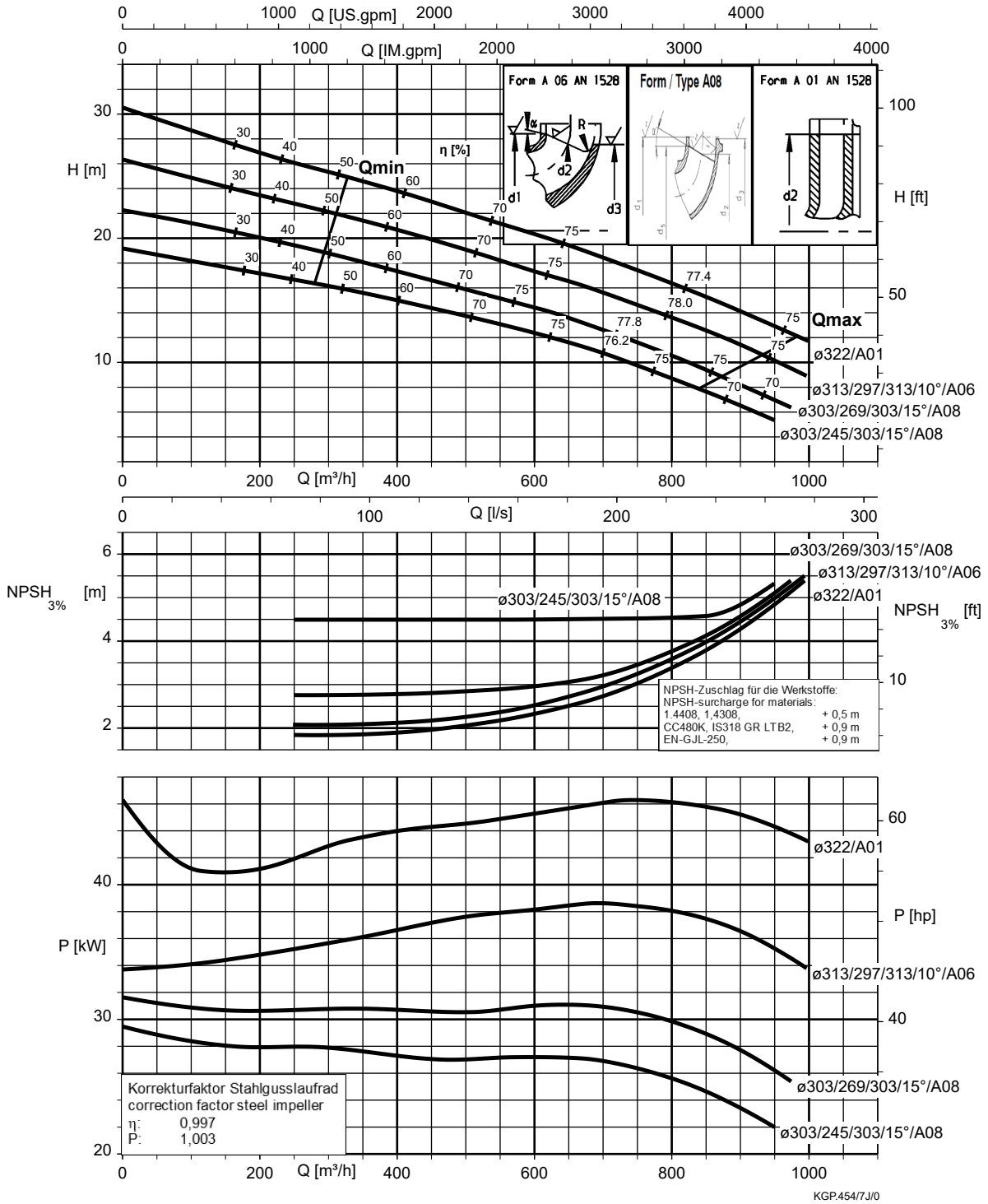

Vlet , Velta 300-250-320 , n = 1450 rpm

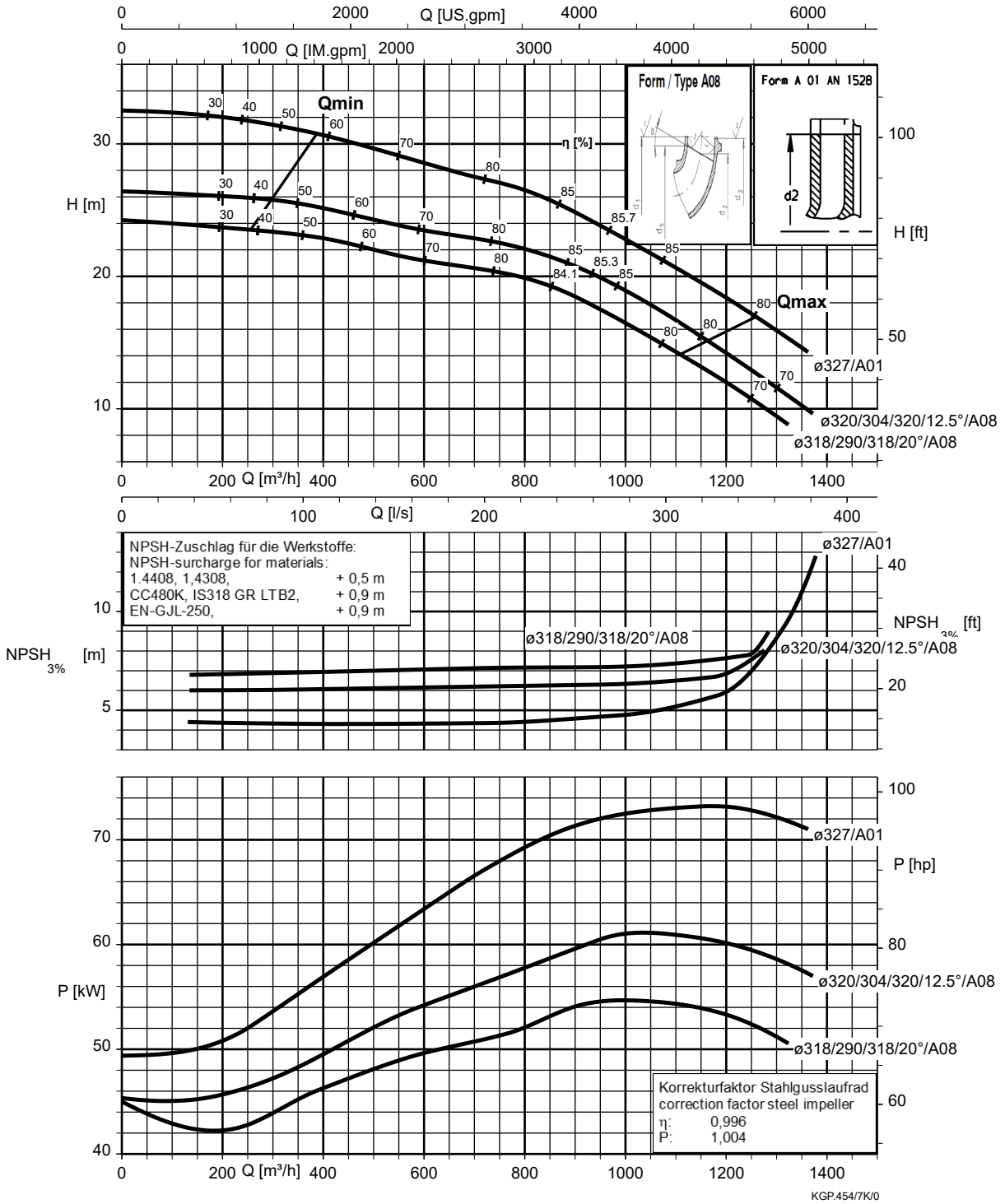

Vlet , Velta 300-250-375, n = 1450 rpm

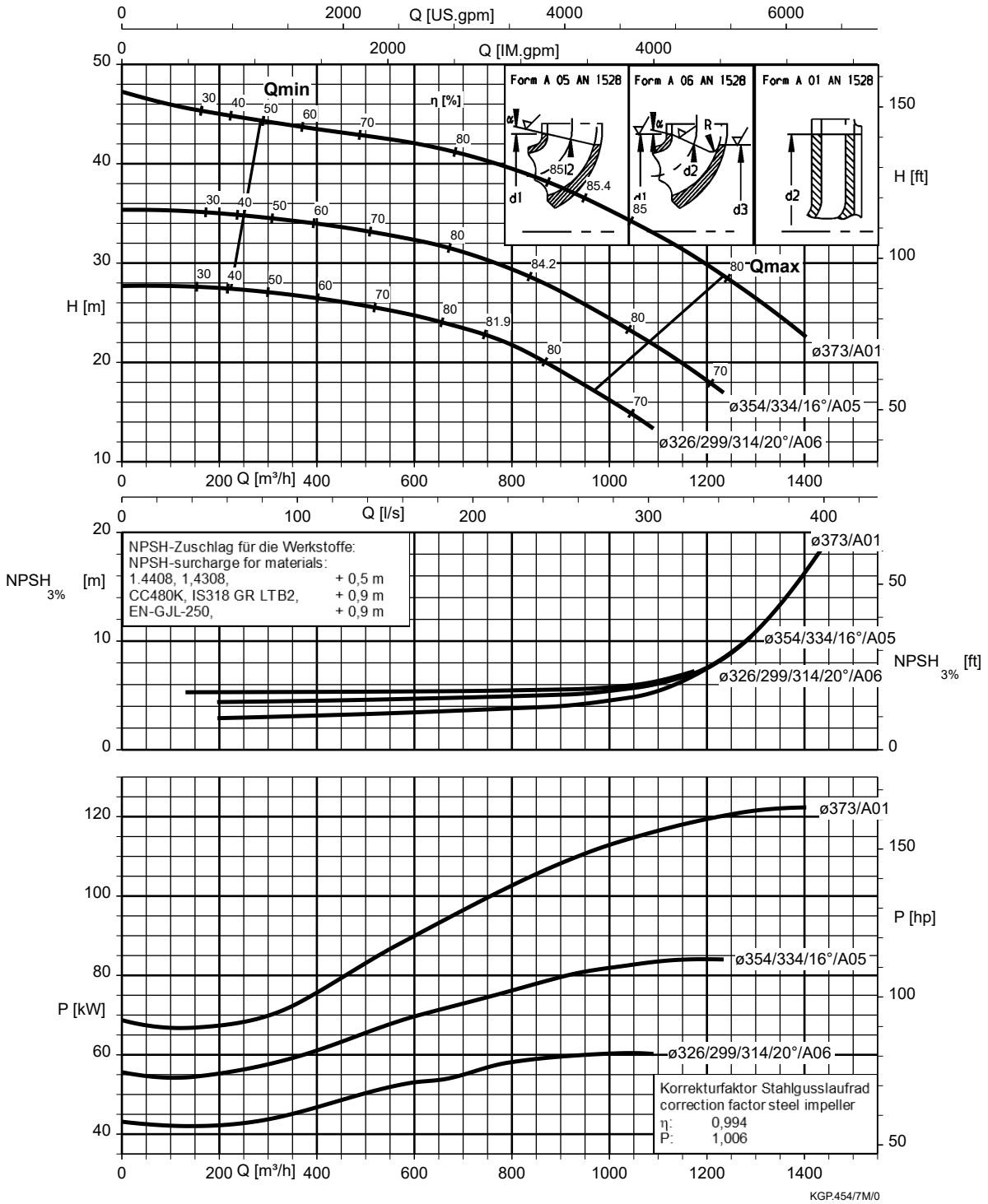

Vlet , Velta 300-250-435 , n = 1450 rpm

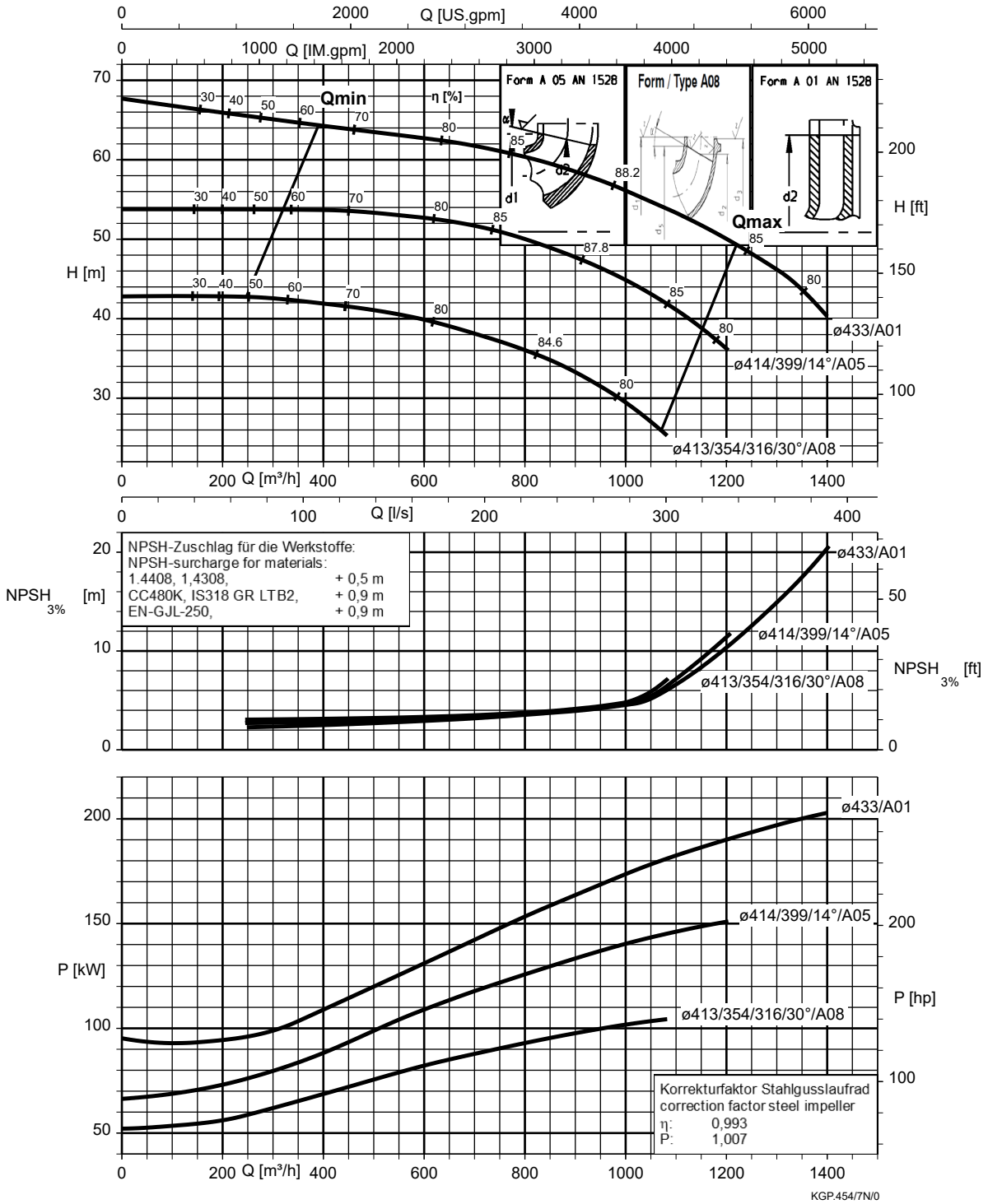



Vlet , Velta 300-250-510, n = 1450 rpm

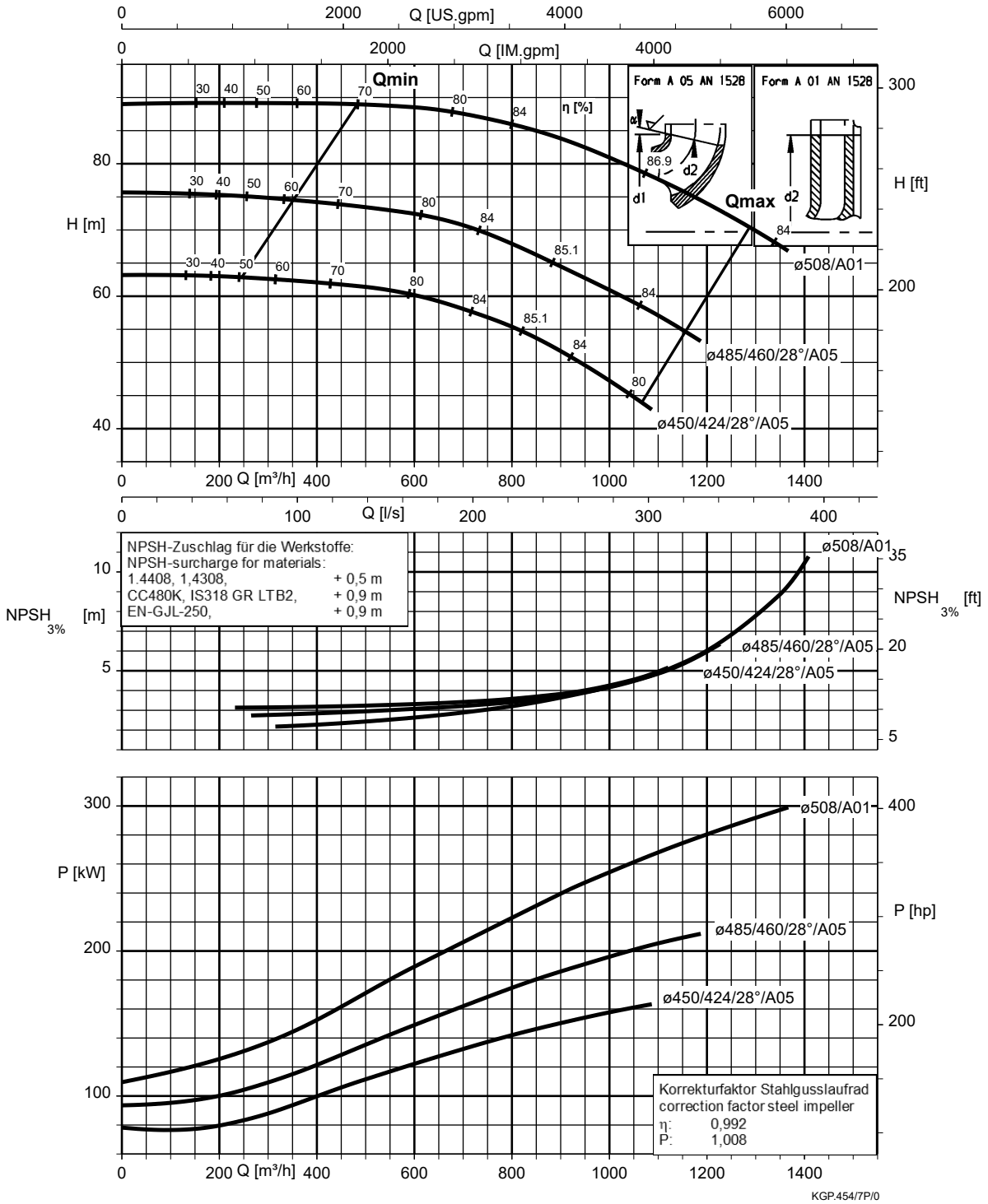

Vlet, Velta 350-300-350, n = 1450 rpm

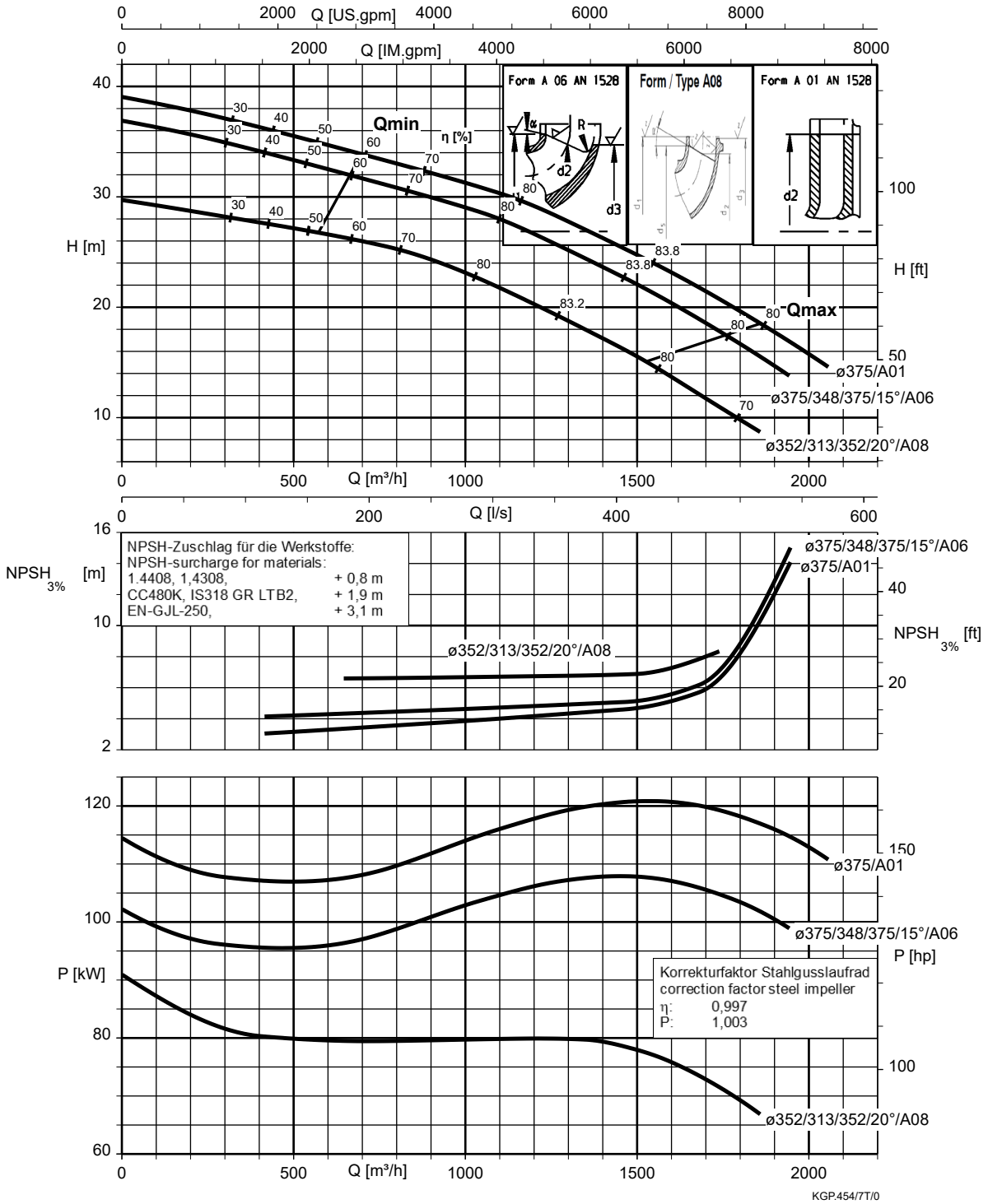

Vlet , Velta 350-300-350.1 , n = 1450 rpm

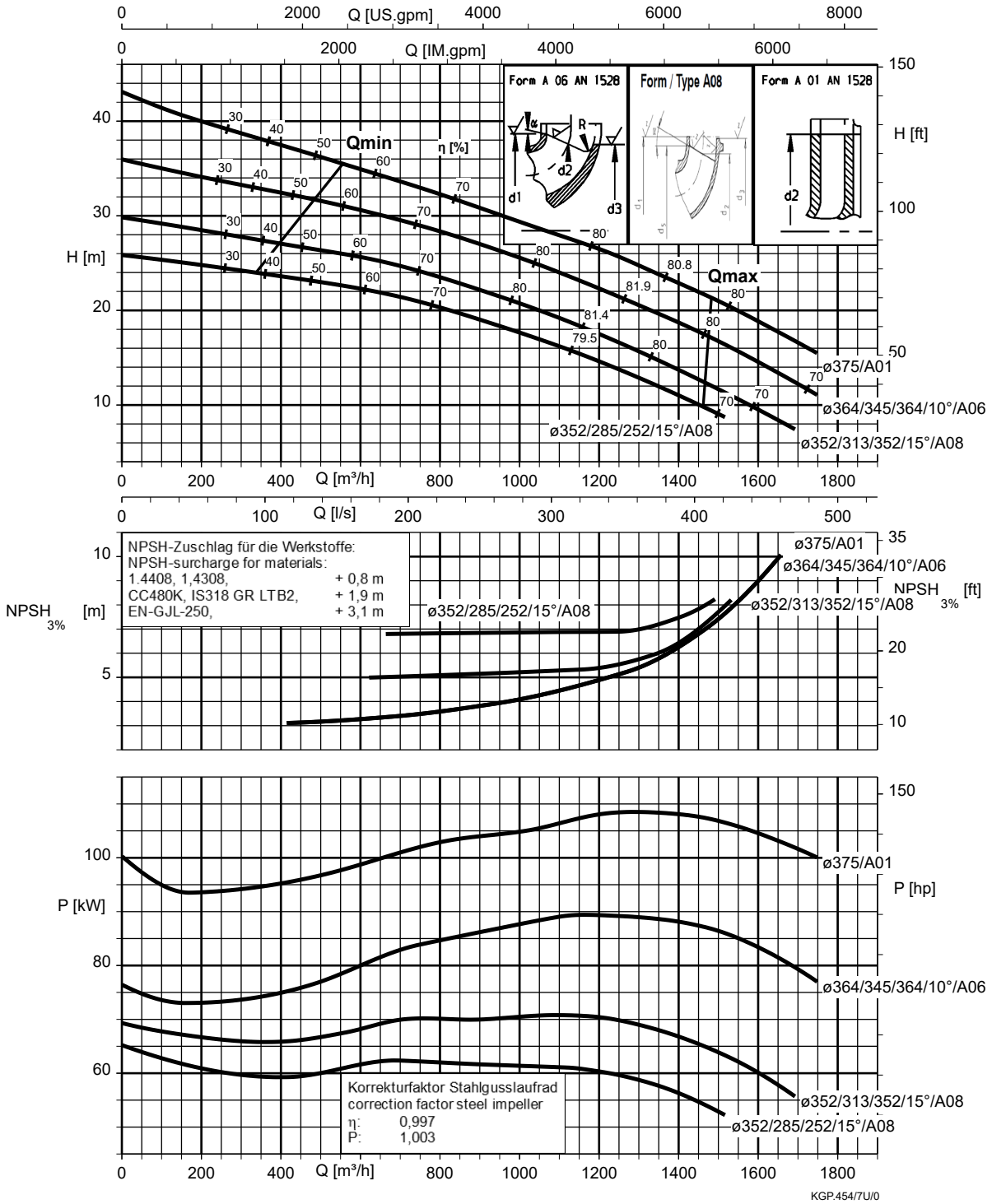

Vlet, Velta 350-300-375, n = 1450 rpm

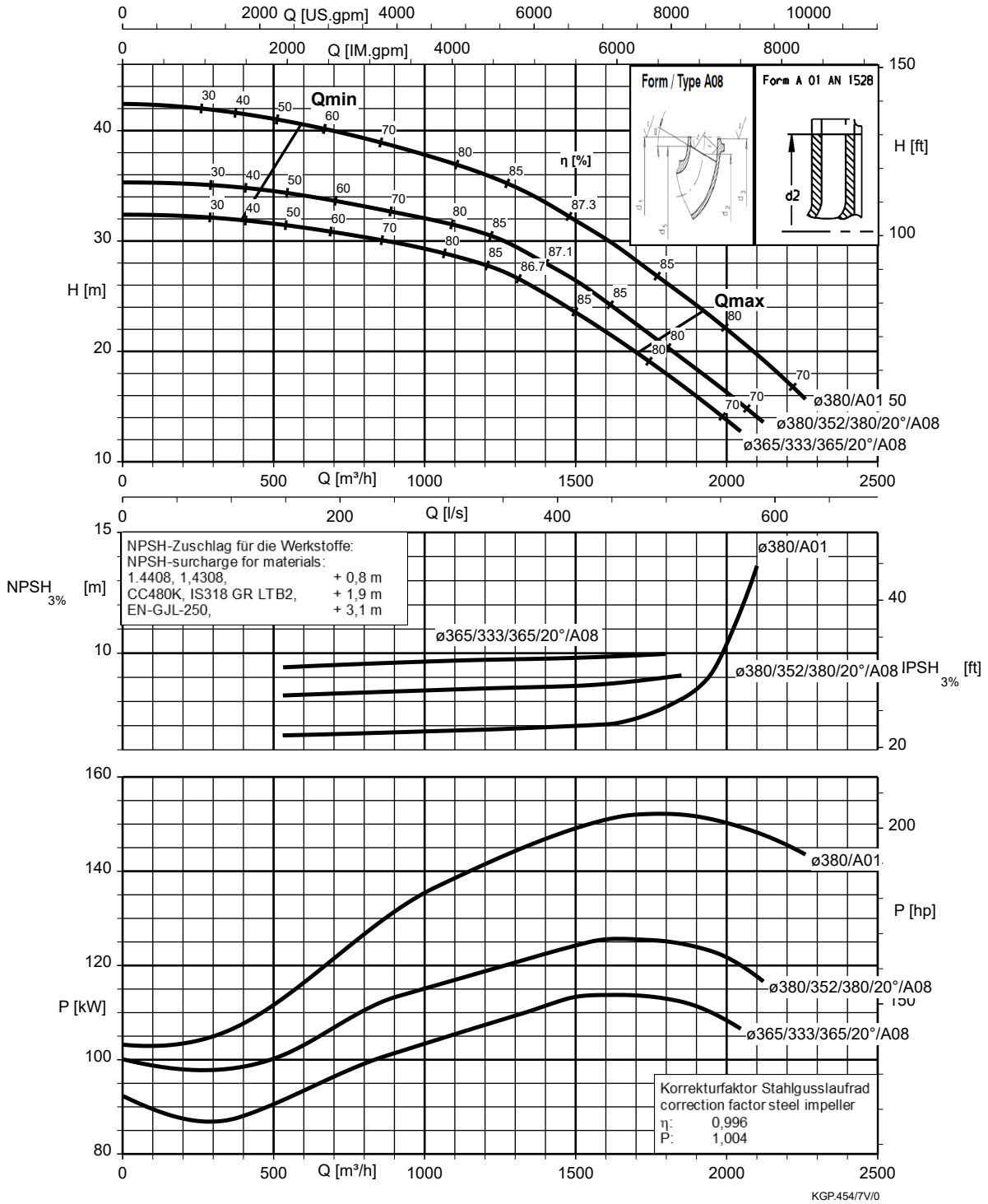

Vlet, Velta 350-300-435, n = 1450 rpm

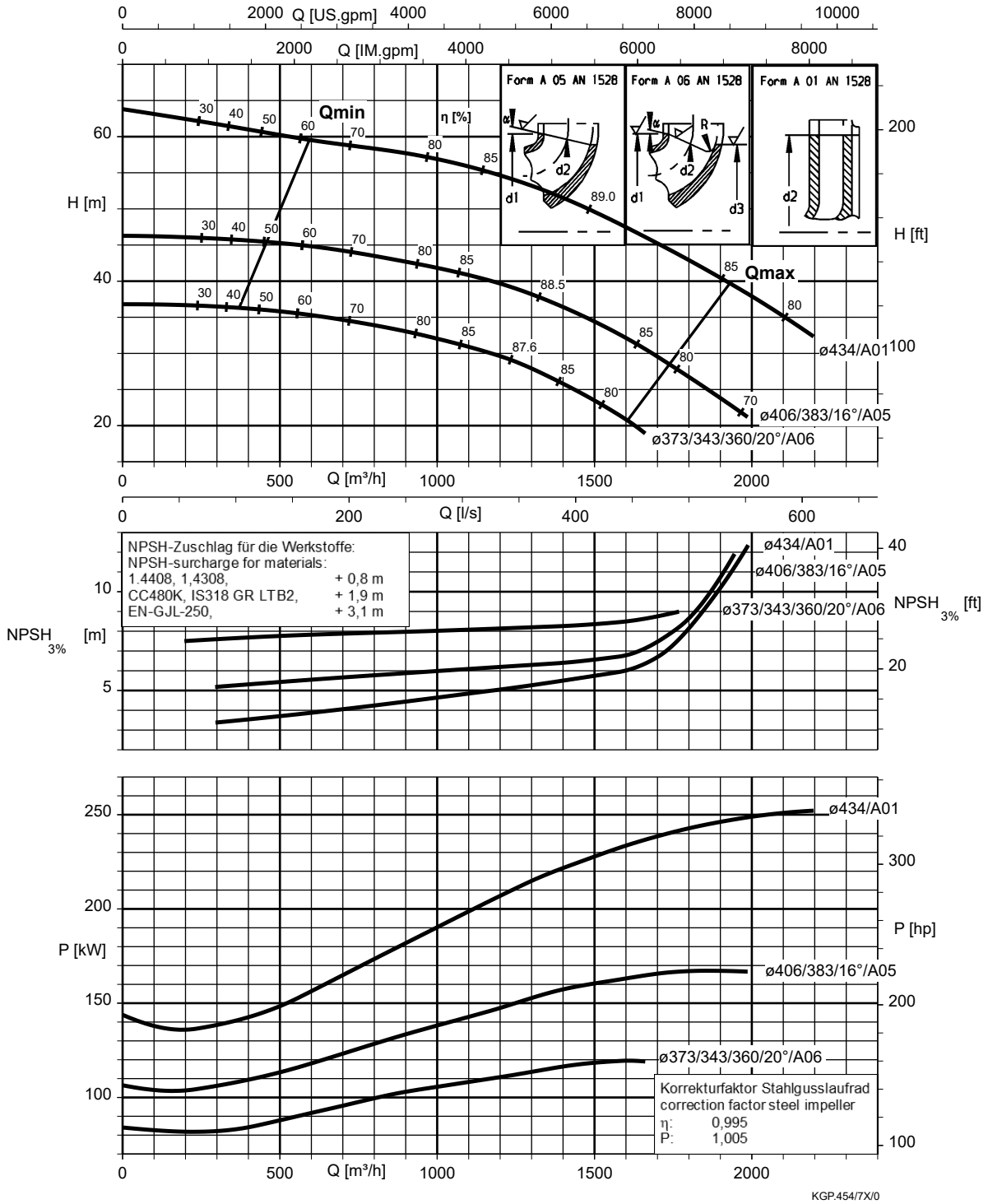

Vlet , Velta 350-300-510 , n = 1450 rpm

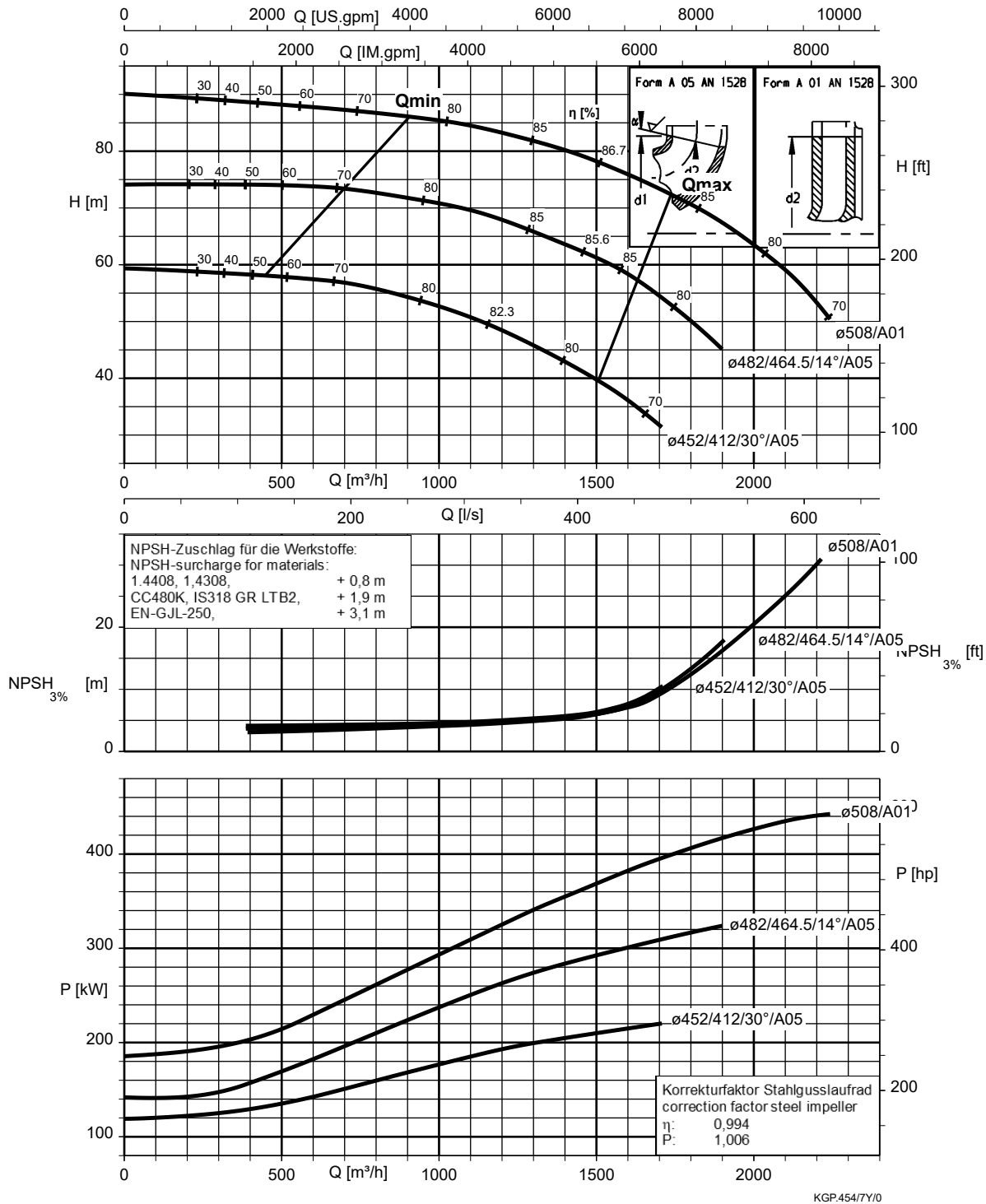

n = 960 rpm

Vlet , Velta 040-025-160, n = 960 rpm

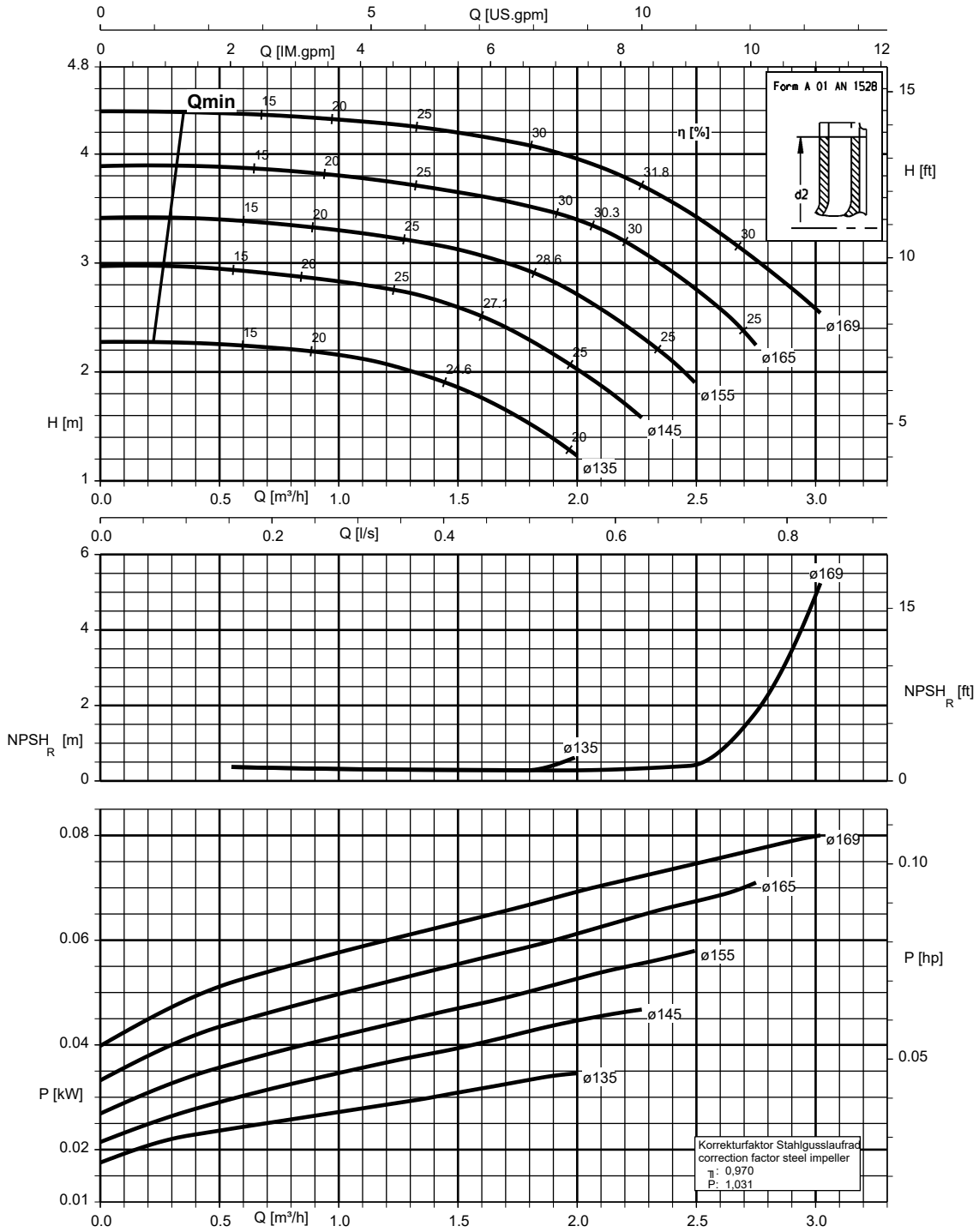

K1311.456/14/2

Vlet , Velta 040-025-200, n = 960 rpm

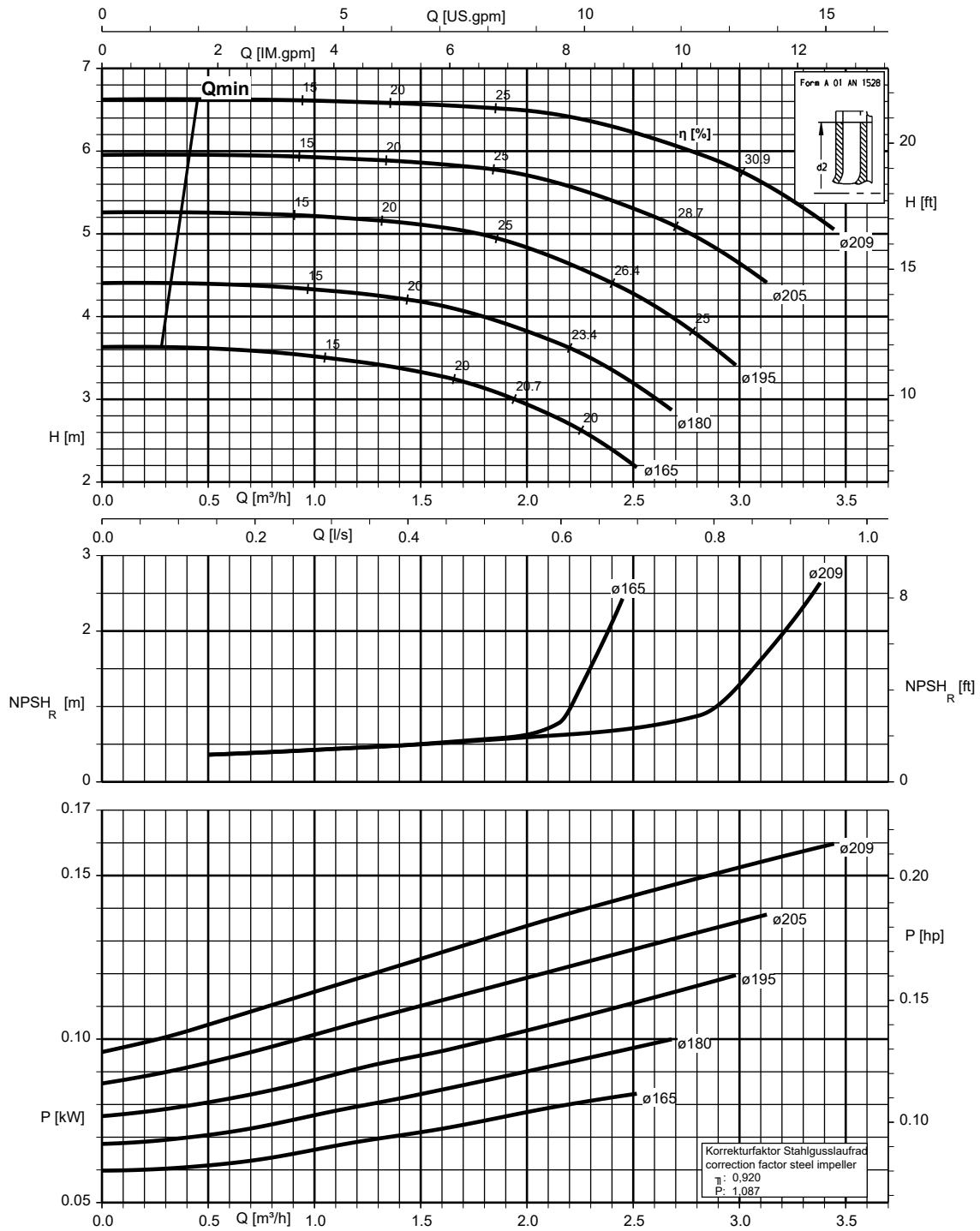

K1311.456/15/2



Vlet , Velta 050-032-125.1, n = 960 rpm

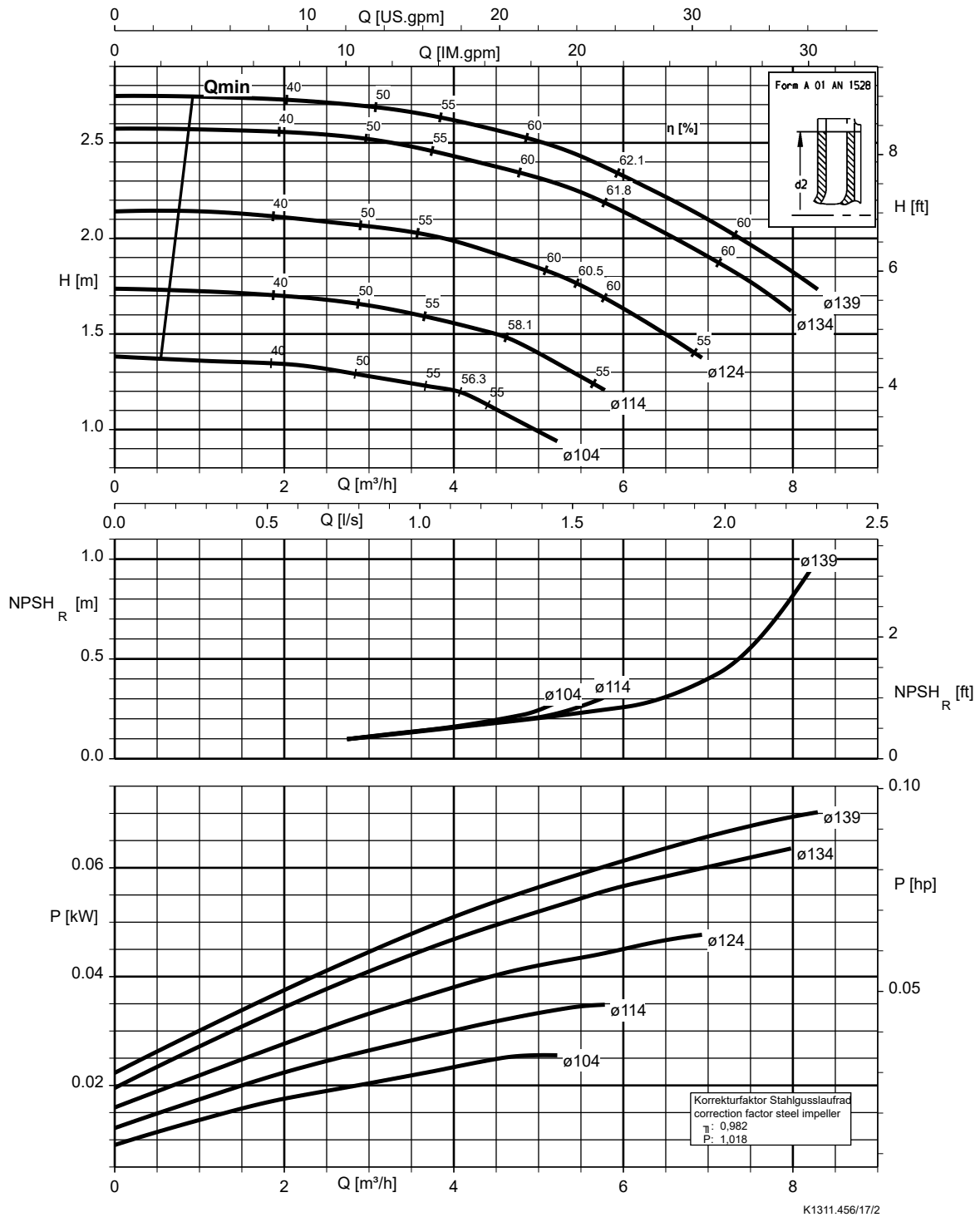

Vlet , Velta 050-032-160.1, n = 960 rpm

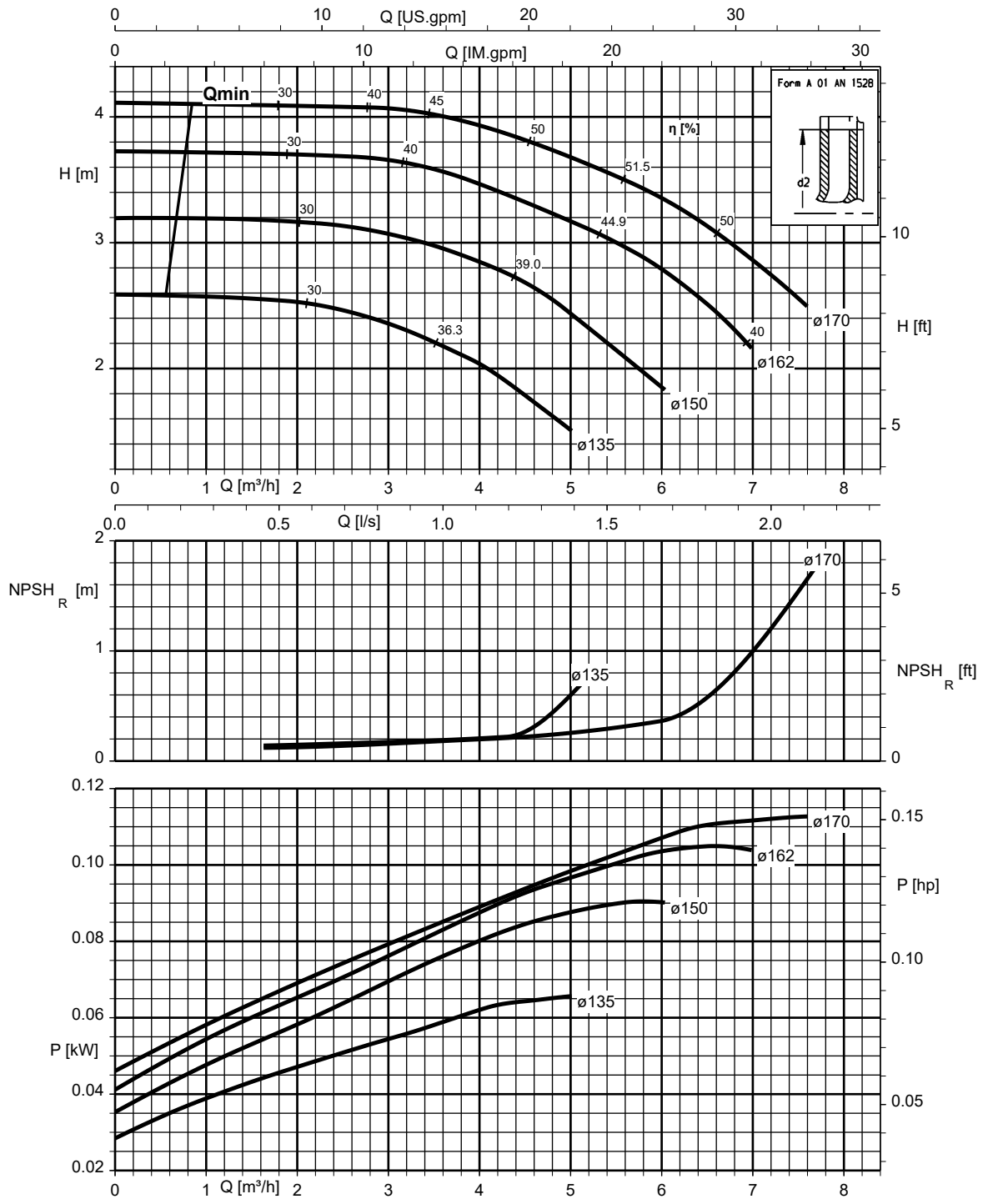

K1311.456/18/2

Vlet , Velta 050-032-200.1, n = 960 rpm

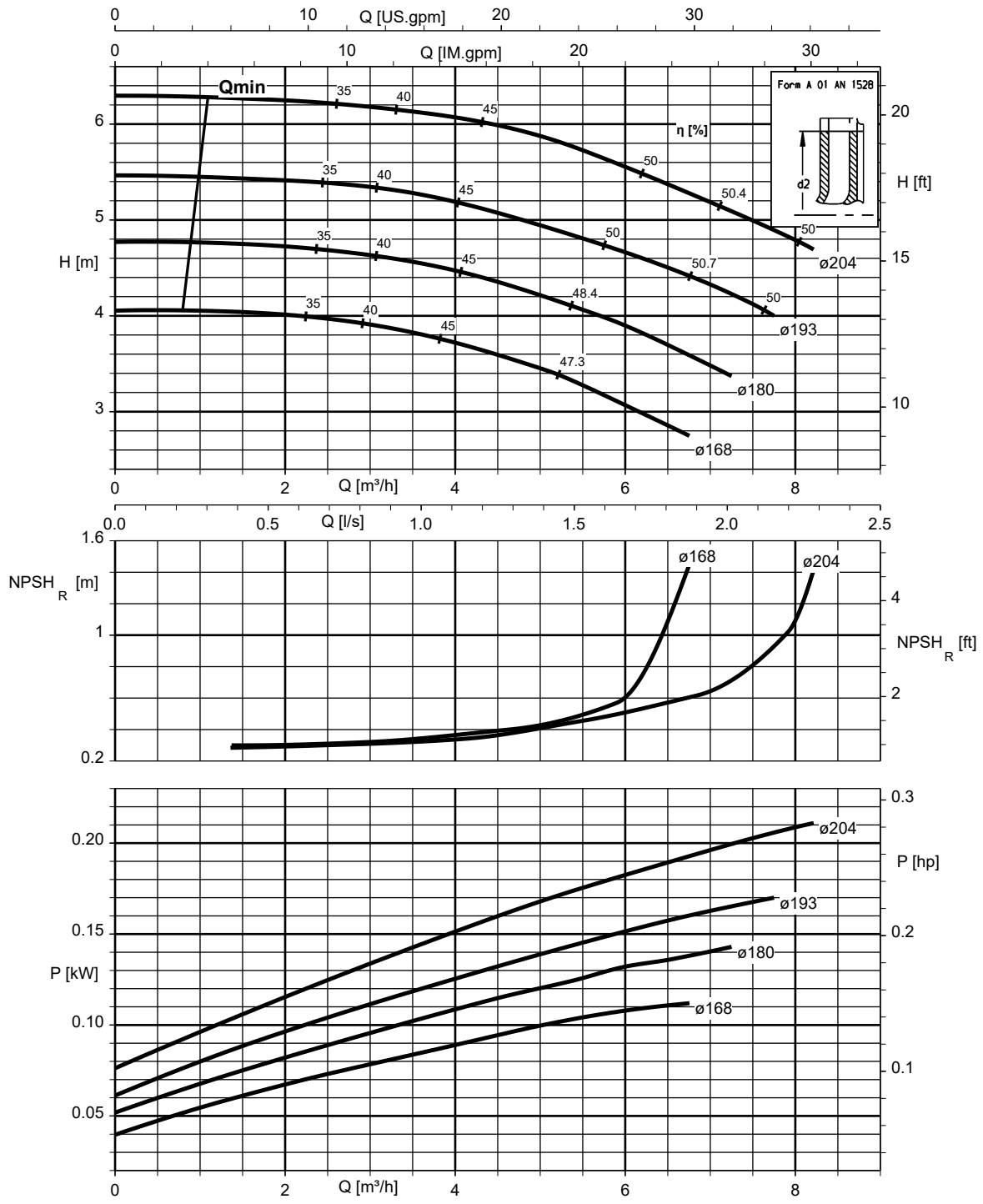

Vlet , Velta 050-032-250.1, n = 960 rpm

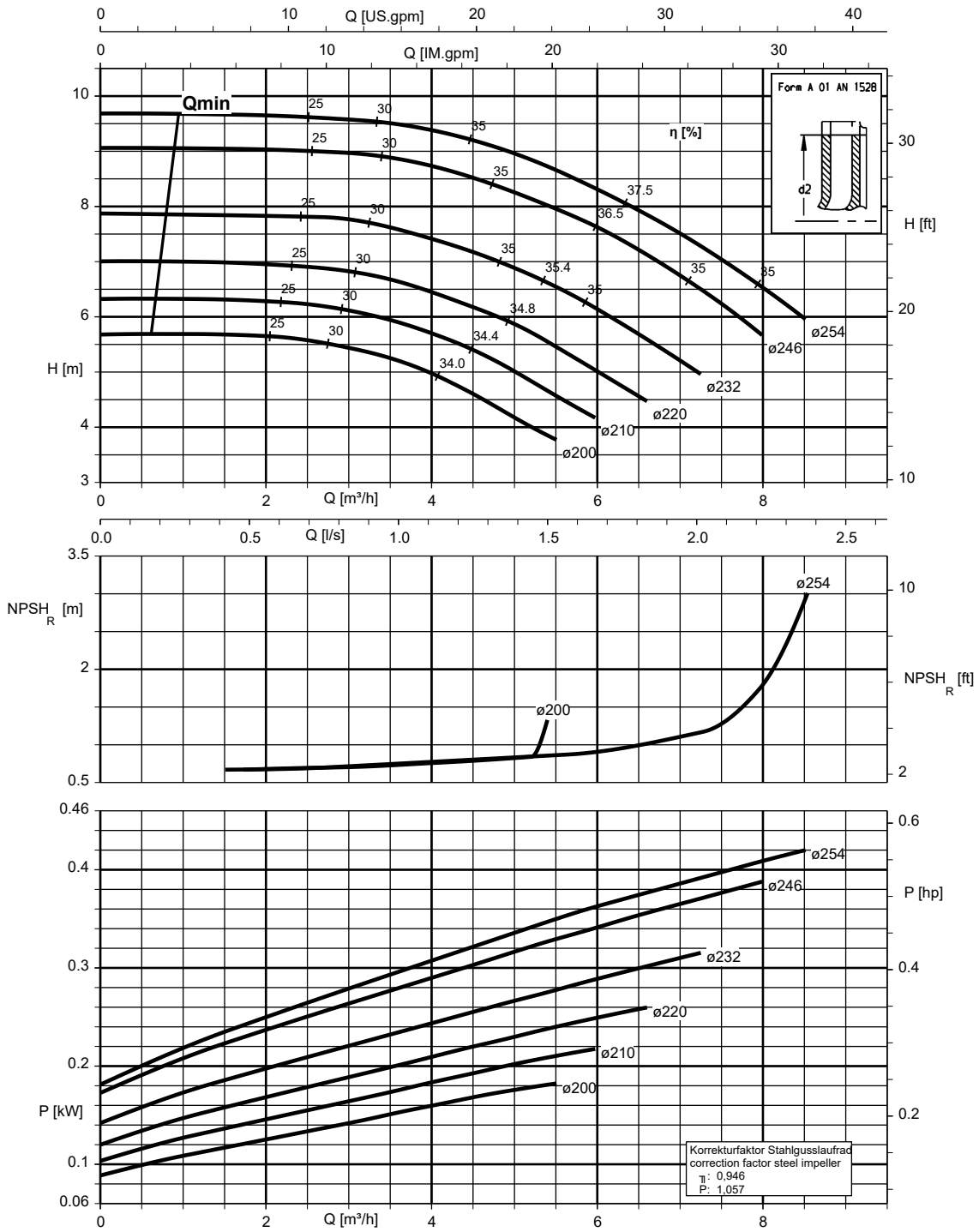

K1311.456/20/2

Vlet , Velta 050-032-125, n = 960 rpm

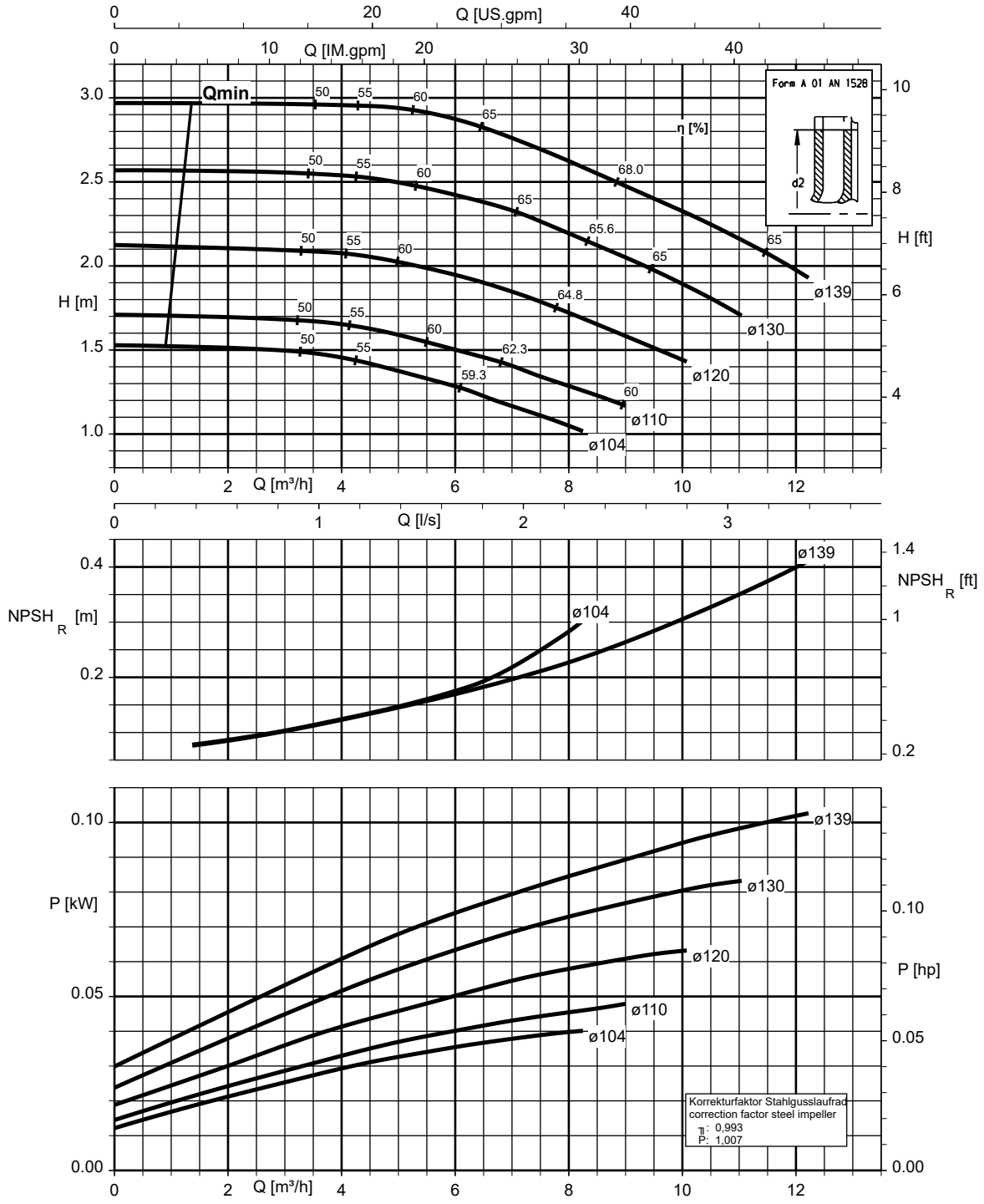

Vlet , Velta 050-032-160, n = 960 rpm

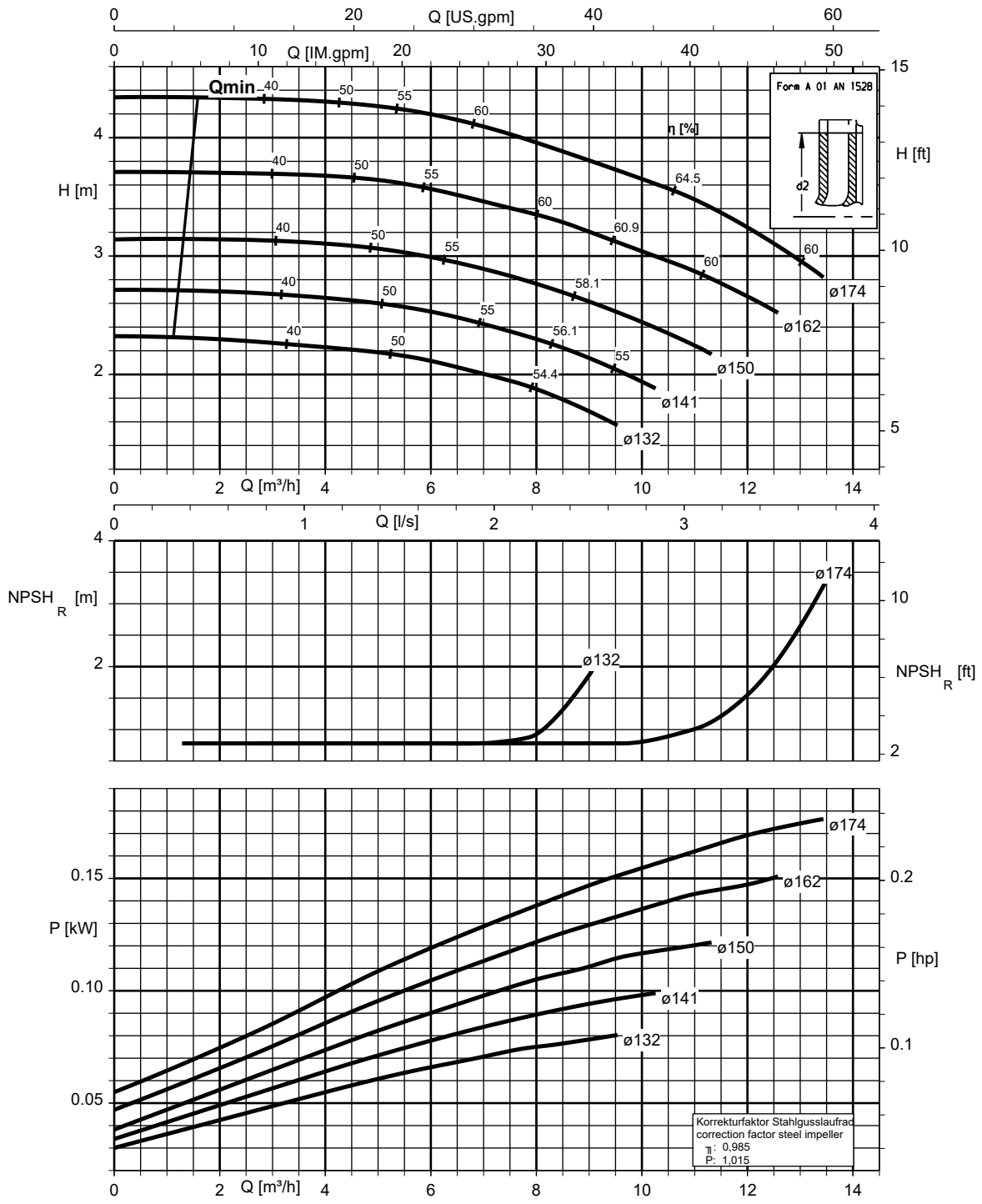

K1311.456/22/3

Vlet , Velta 050-032-200, n = 960 rpm

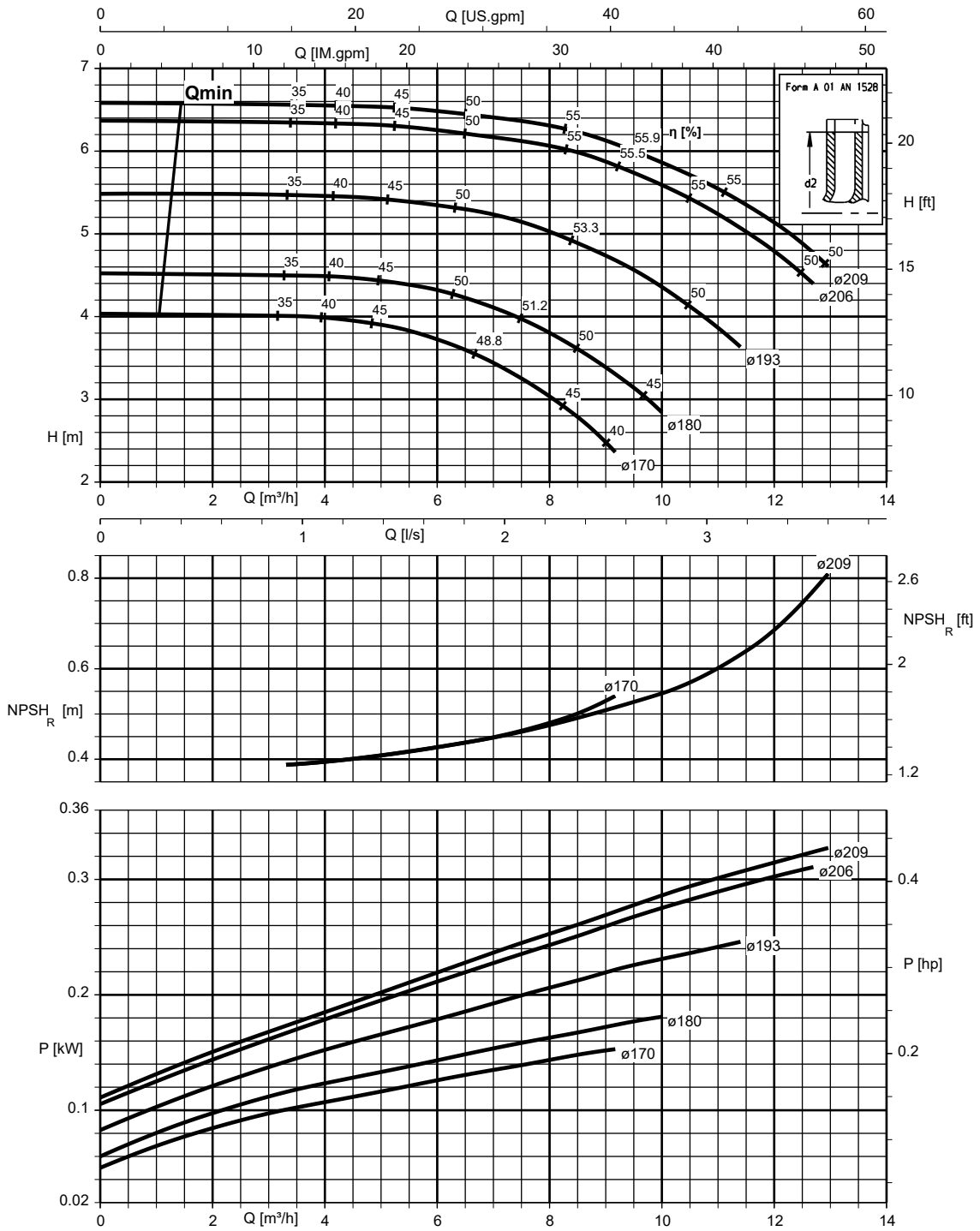

K1311.456/23/1

Vlet , Velta 050-032-250, n = 960 rpm

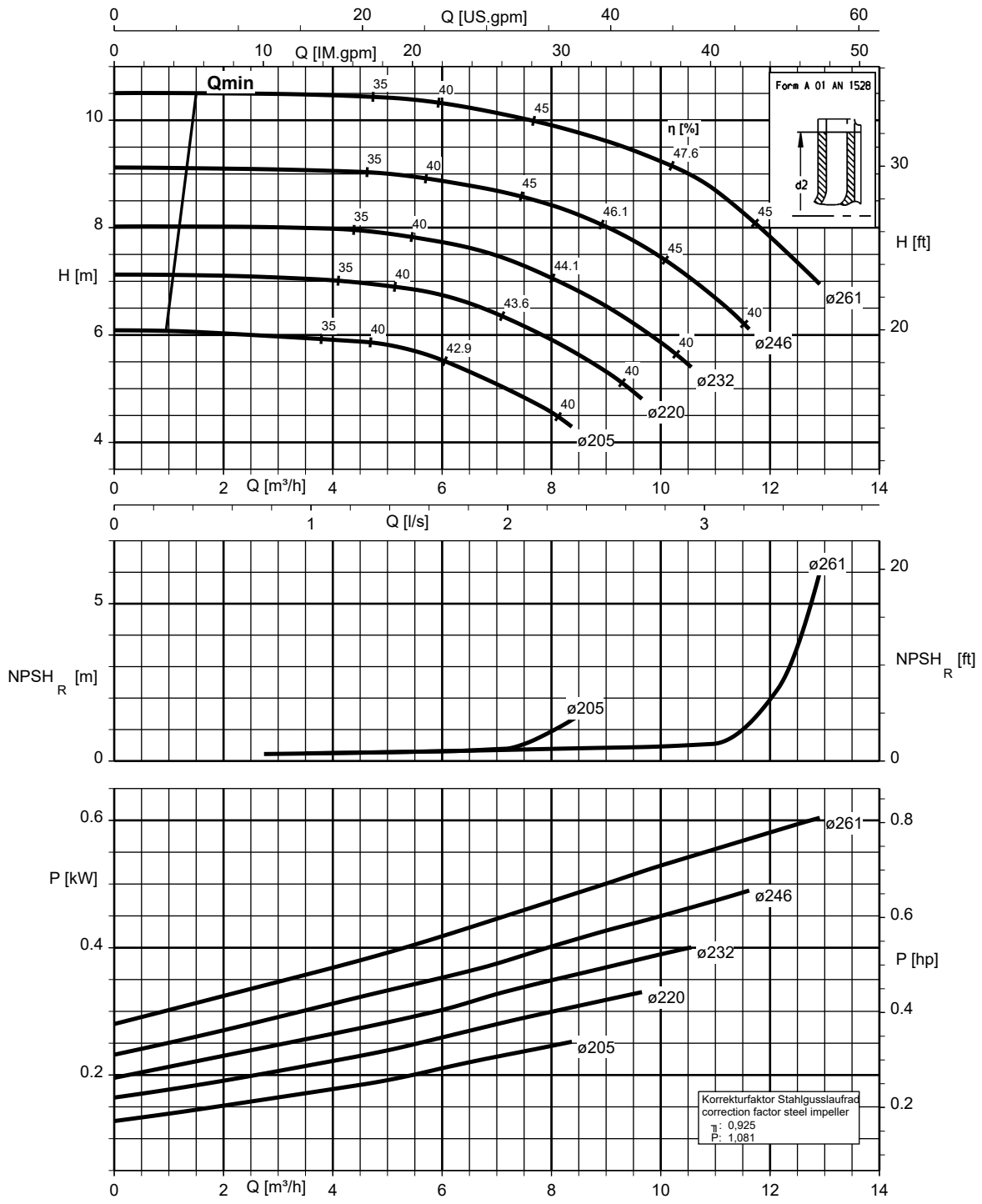



Vlet , Velta 065-040-125, n = 960 rpm

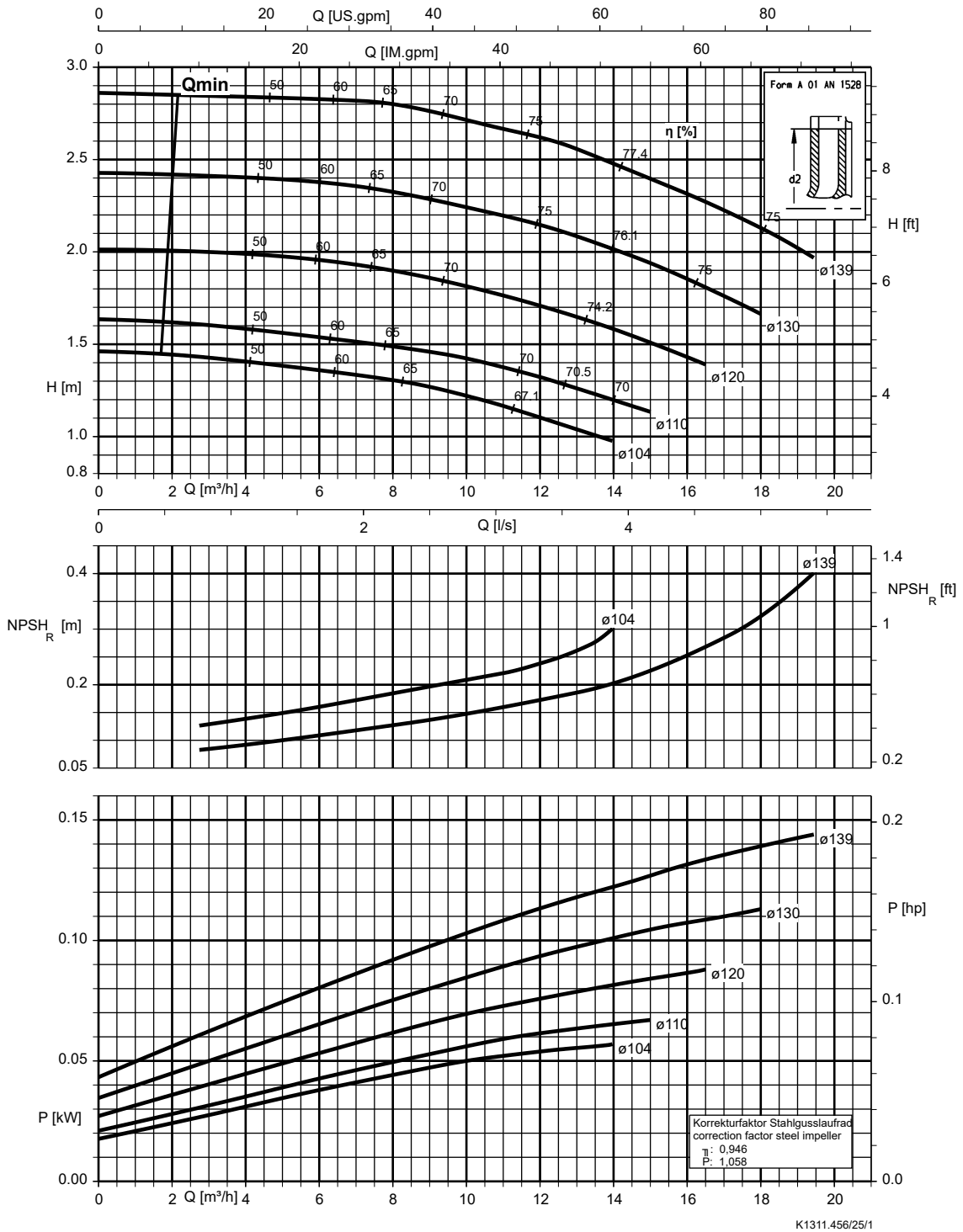

Vlet , Velta 065-040-160, n = 960 rpm

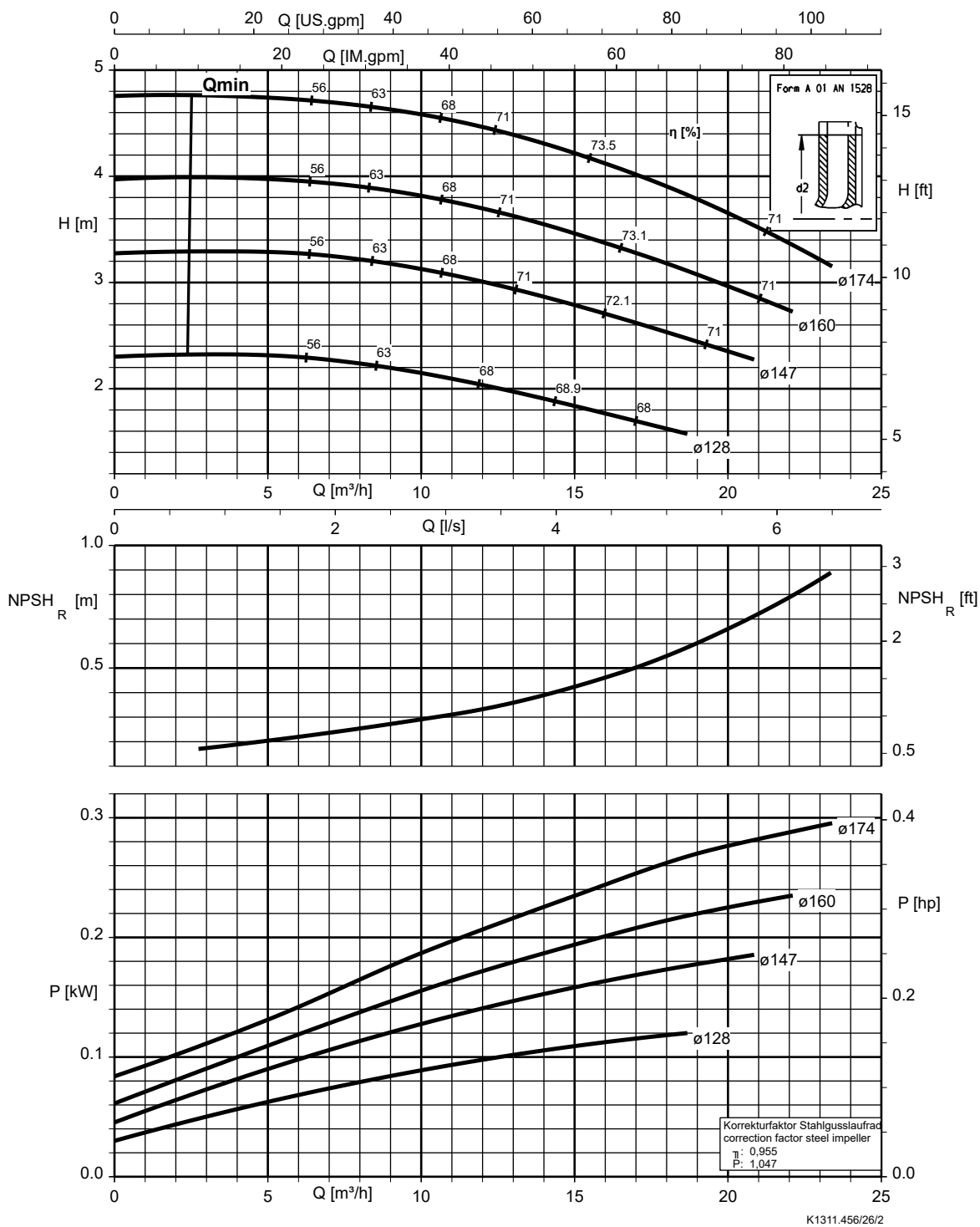

Vlet , Velta 065-040-200, n = 960 rpm

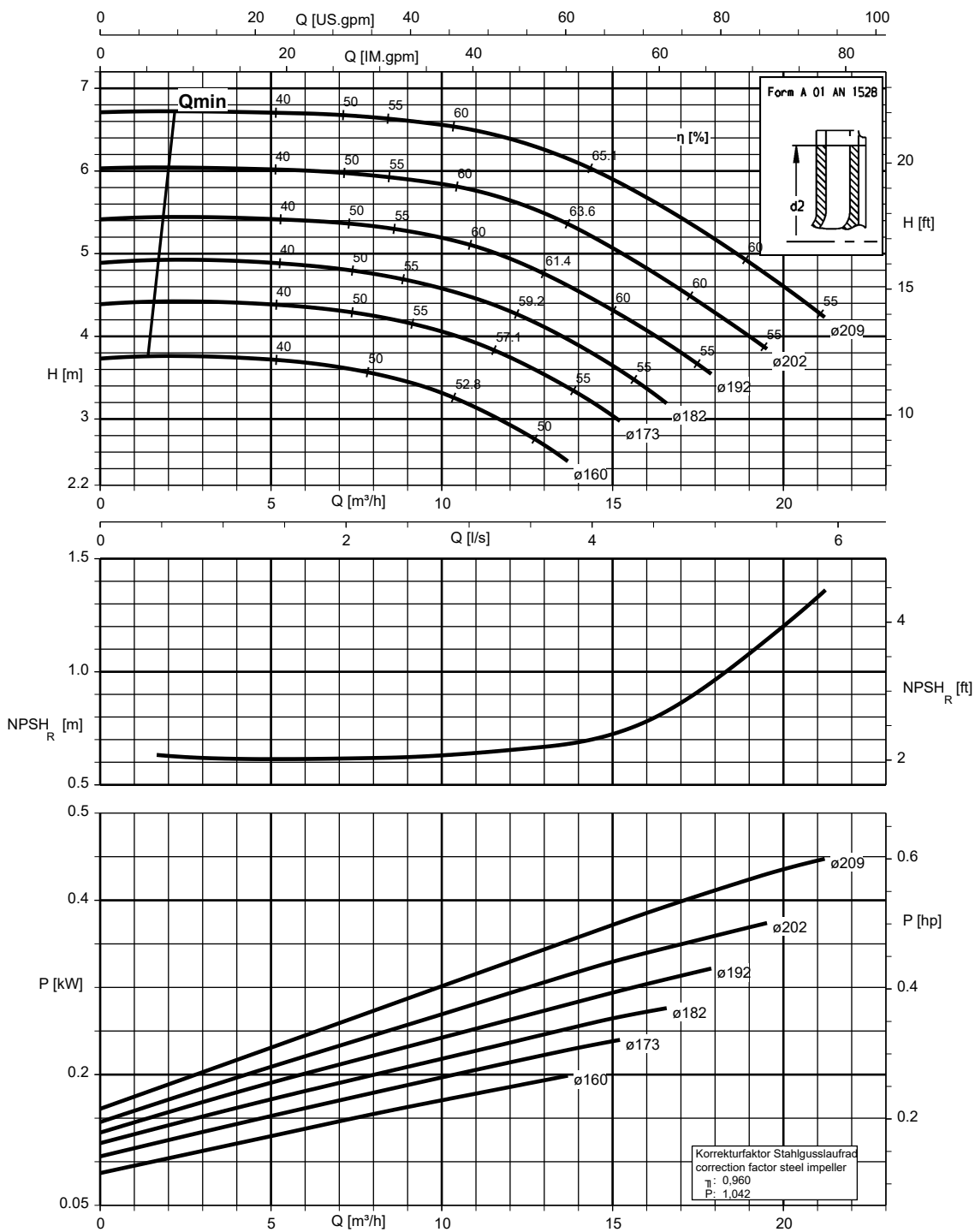

K1311.456/27/1

Vlet , Velta 065-040-250, n = 960 rpm

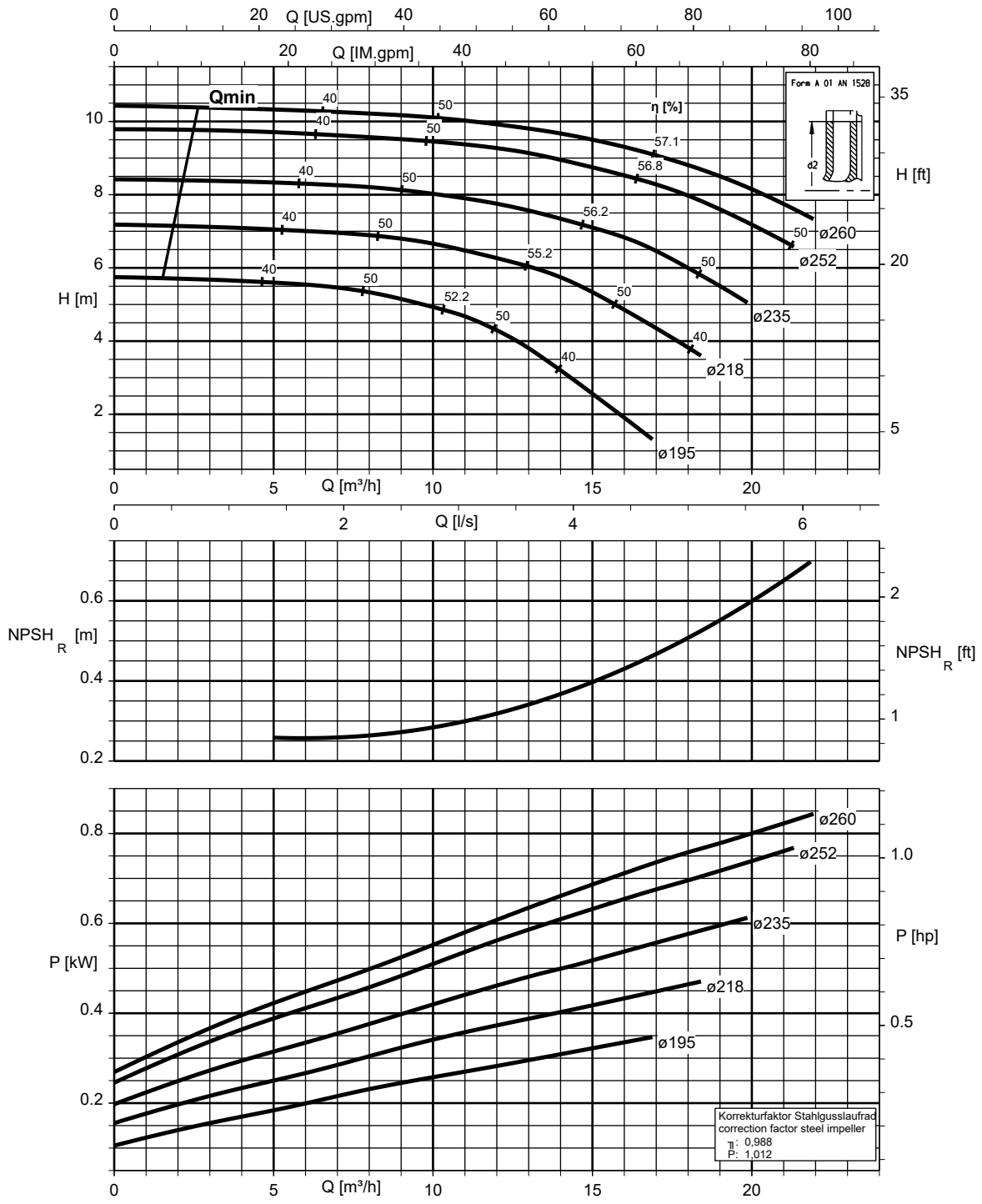

Vlet , Velta 065-040-315, n = 960 rpm

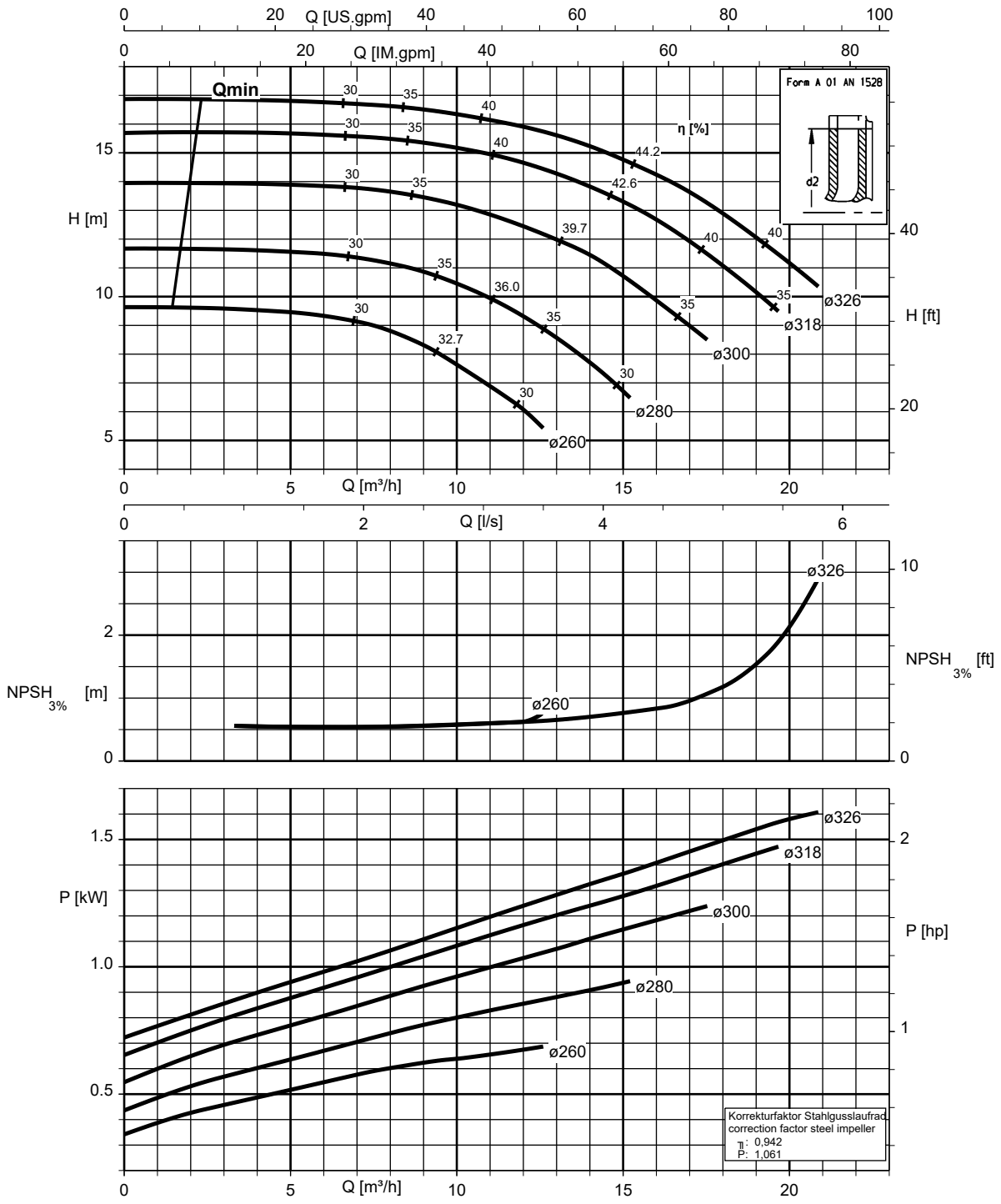

Vlet , Velta 065-050-125, n = 960 rpm

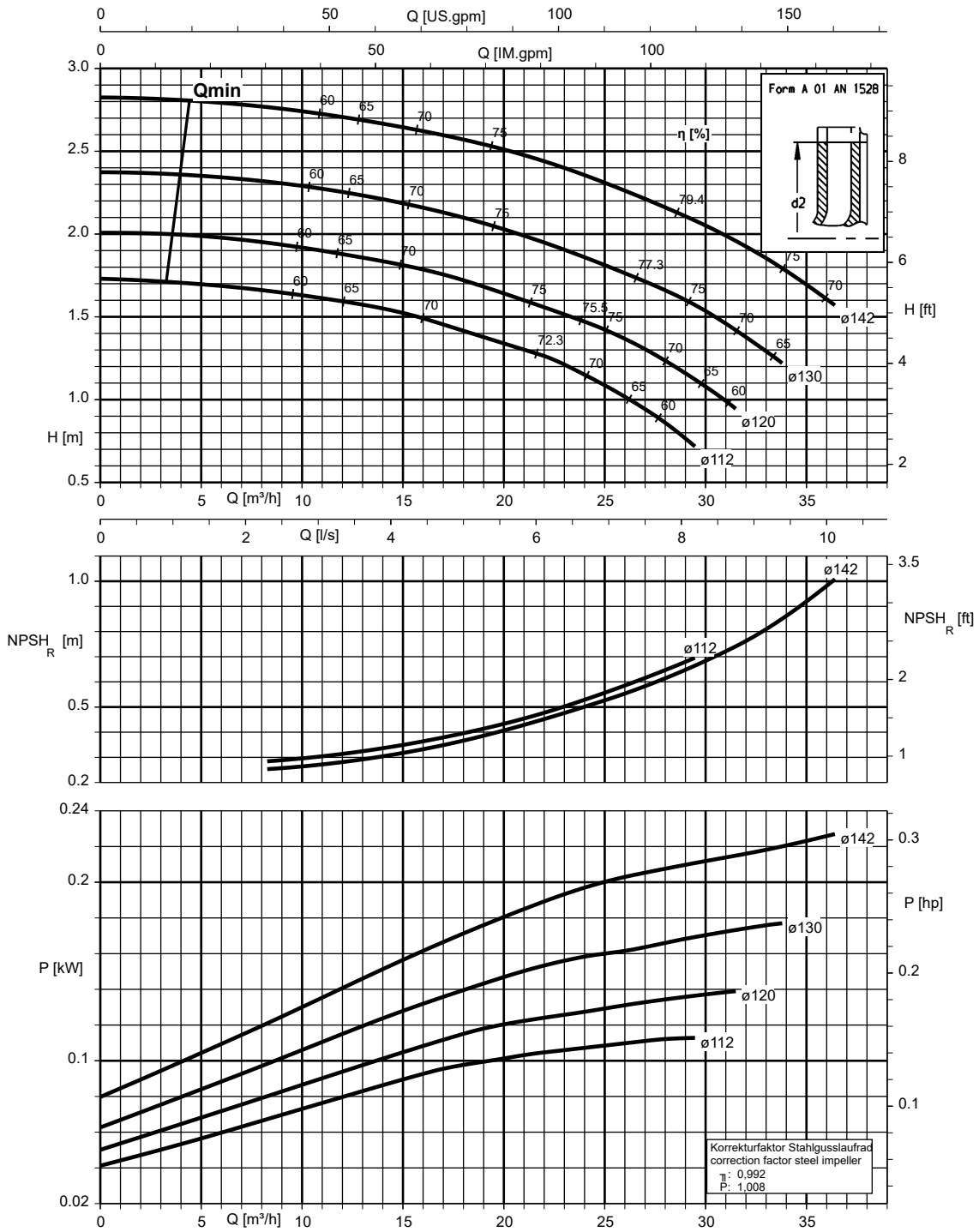

K1311.456/30/1

Vlet , Velta 065-050-160, n = 960 rpm

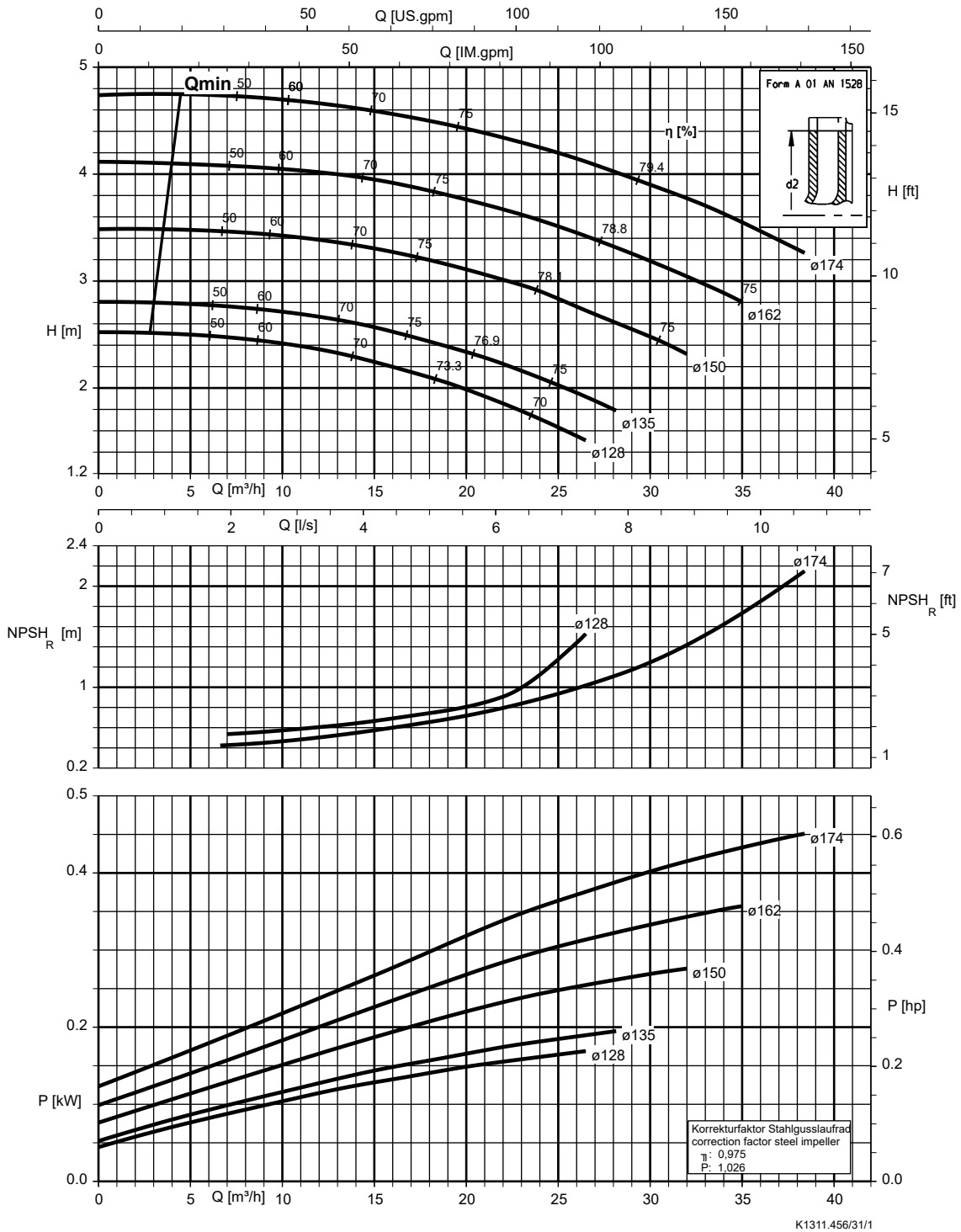

Vlet , Velta 065-050-200, n = 960 rpm

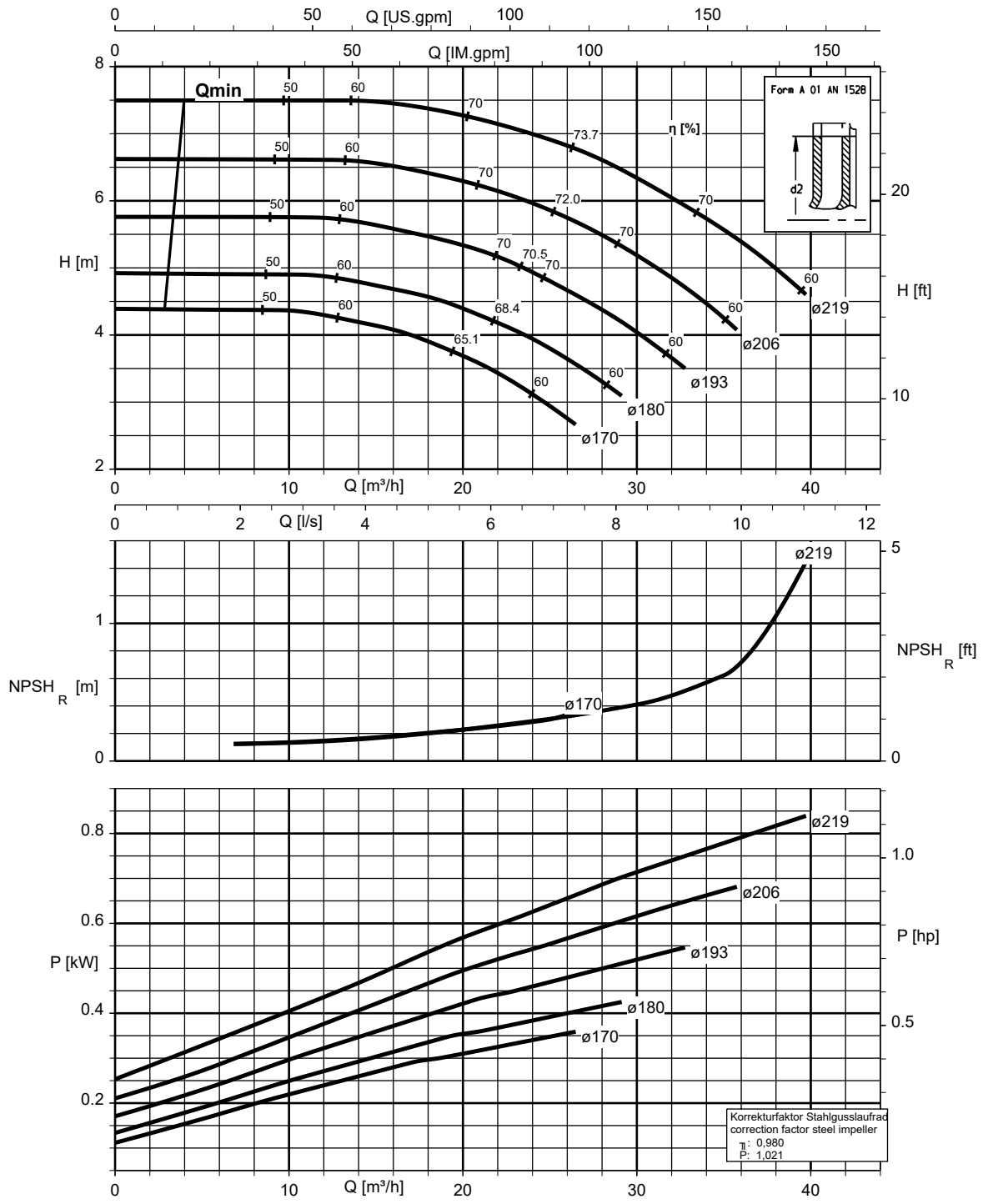



Vlet , Velta 065-050-250, n = 960 rpm

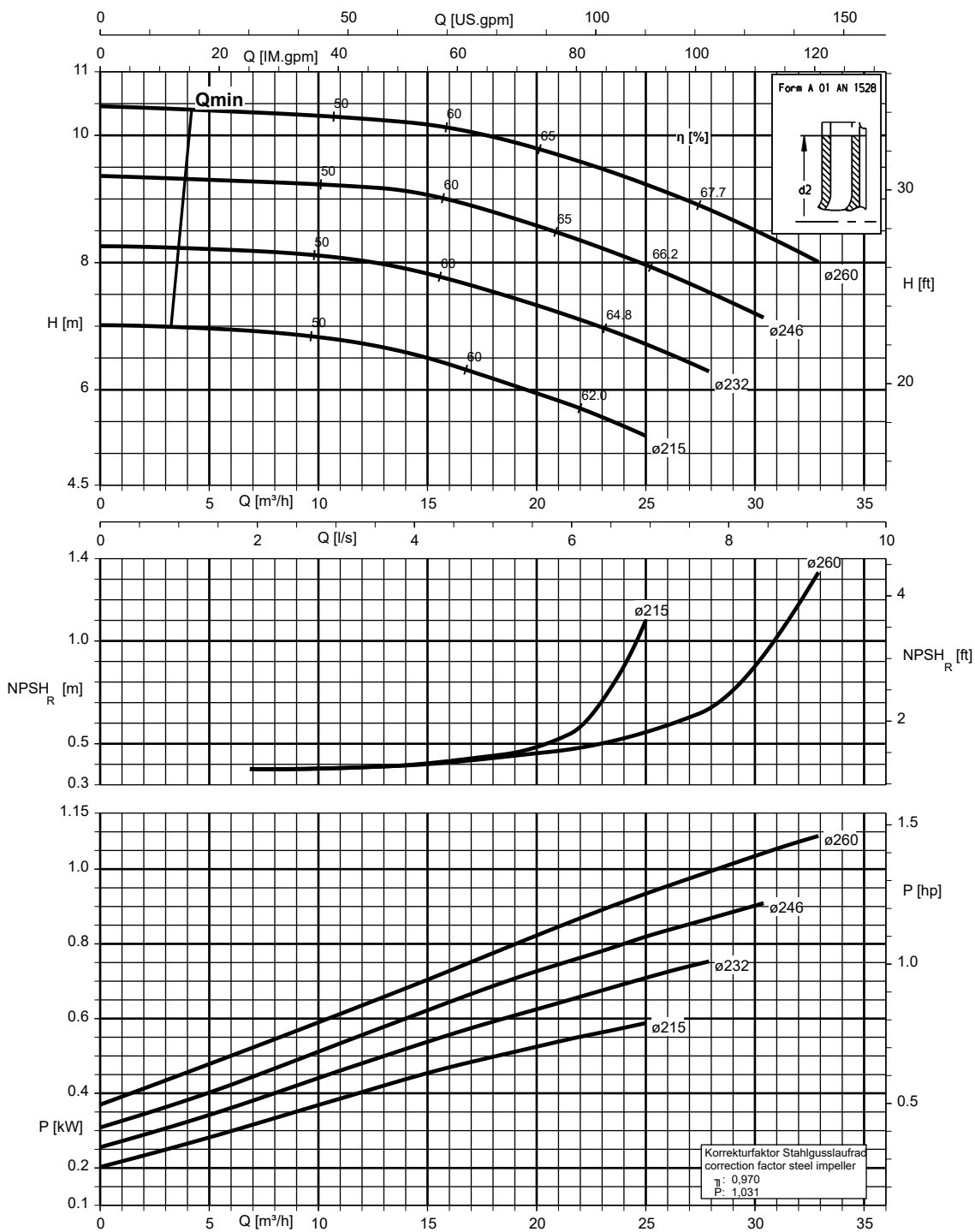

K1311.456/33/1

Vlet , Velta 065-050-315, n = 960 rpm

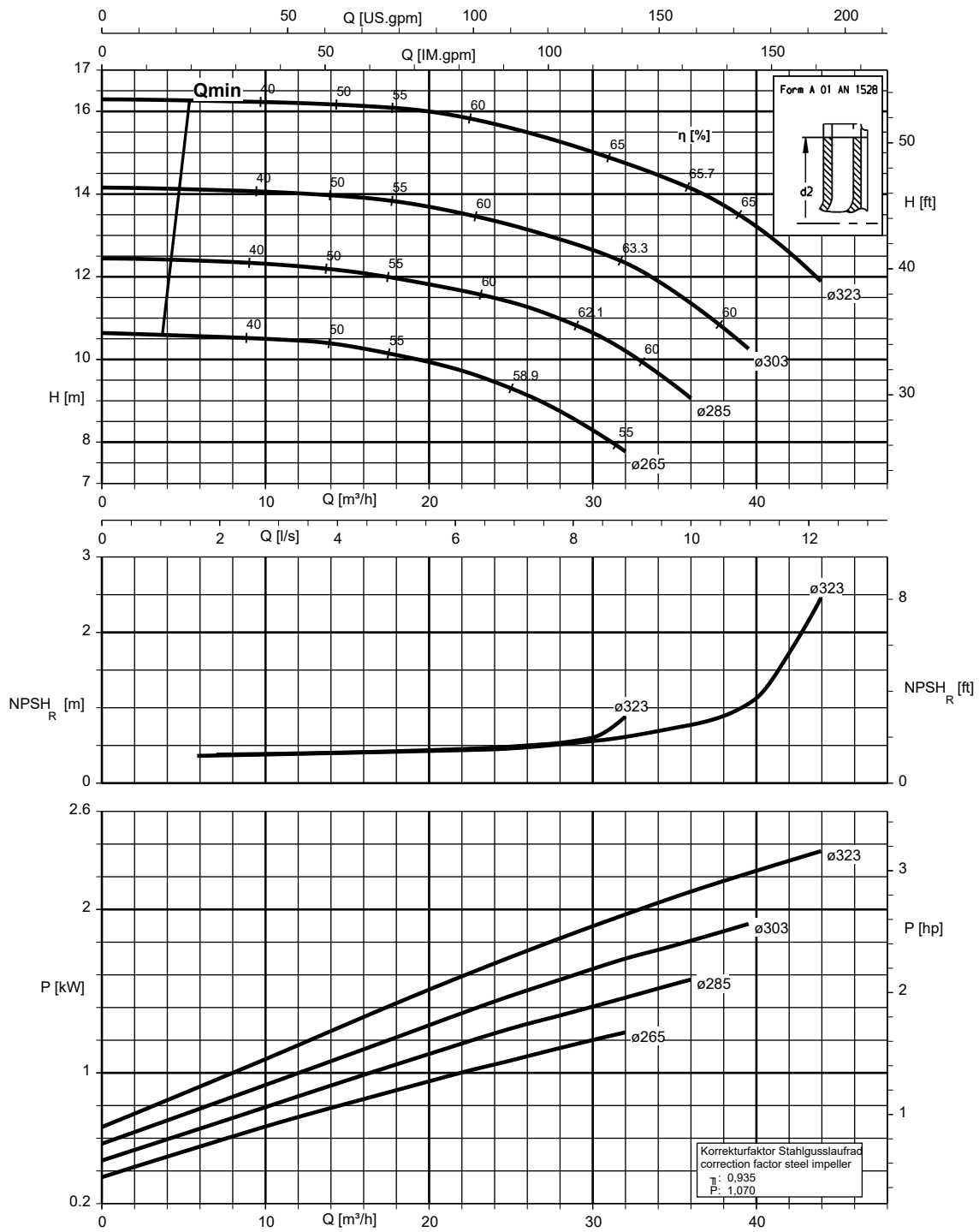

K1311.456/34/2

Vlet , Velta 080-065-125, n = 960 rpm

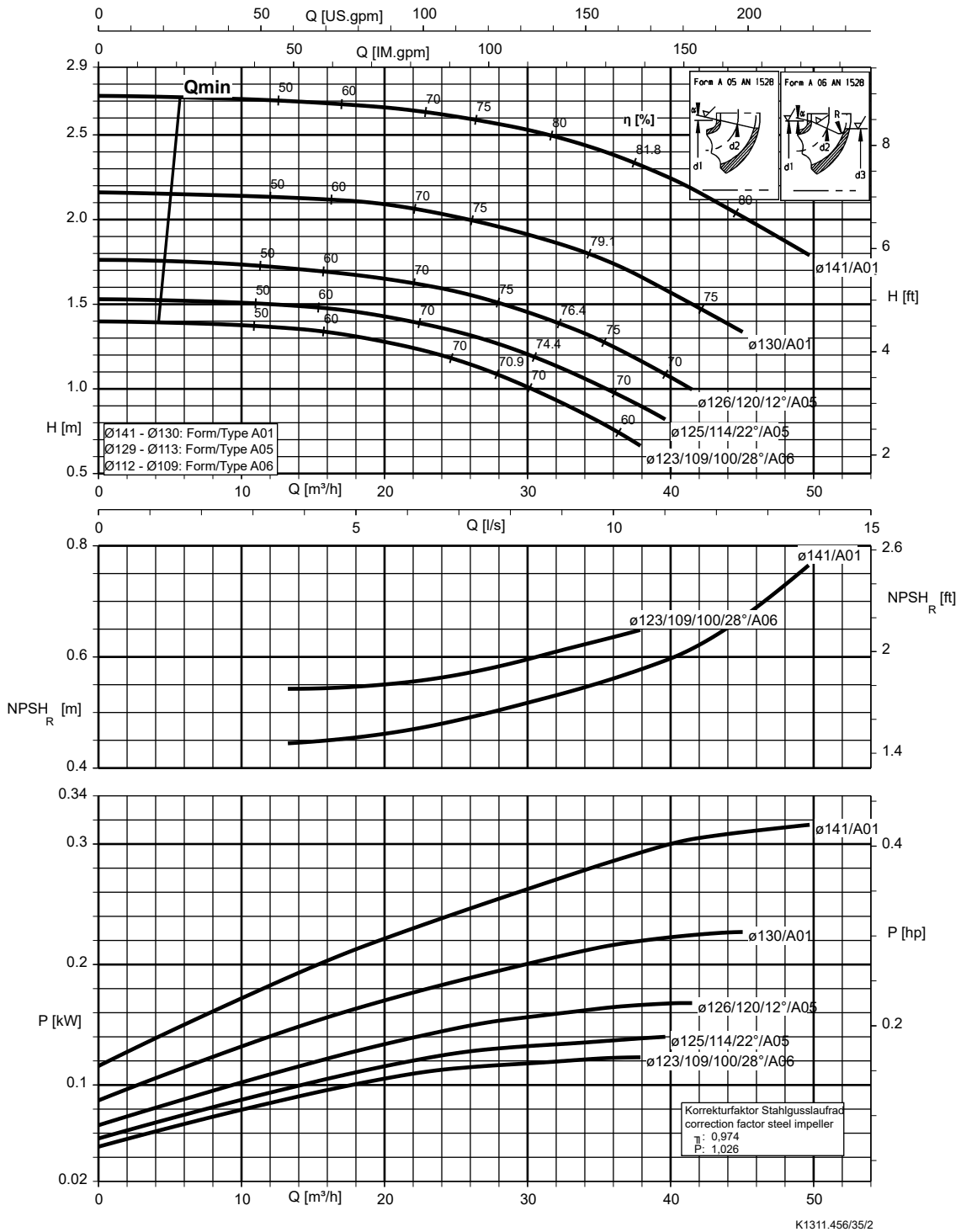

Vlet , Velta 080-065-160, n = 960 rpm

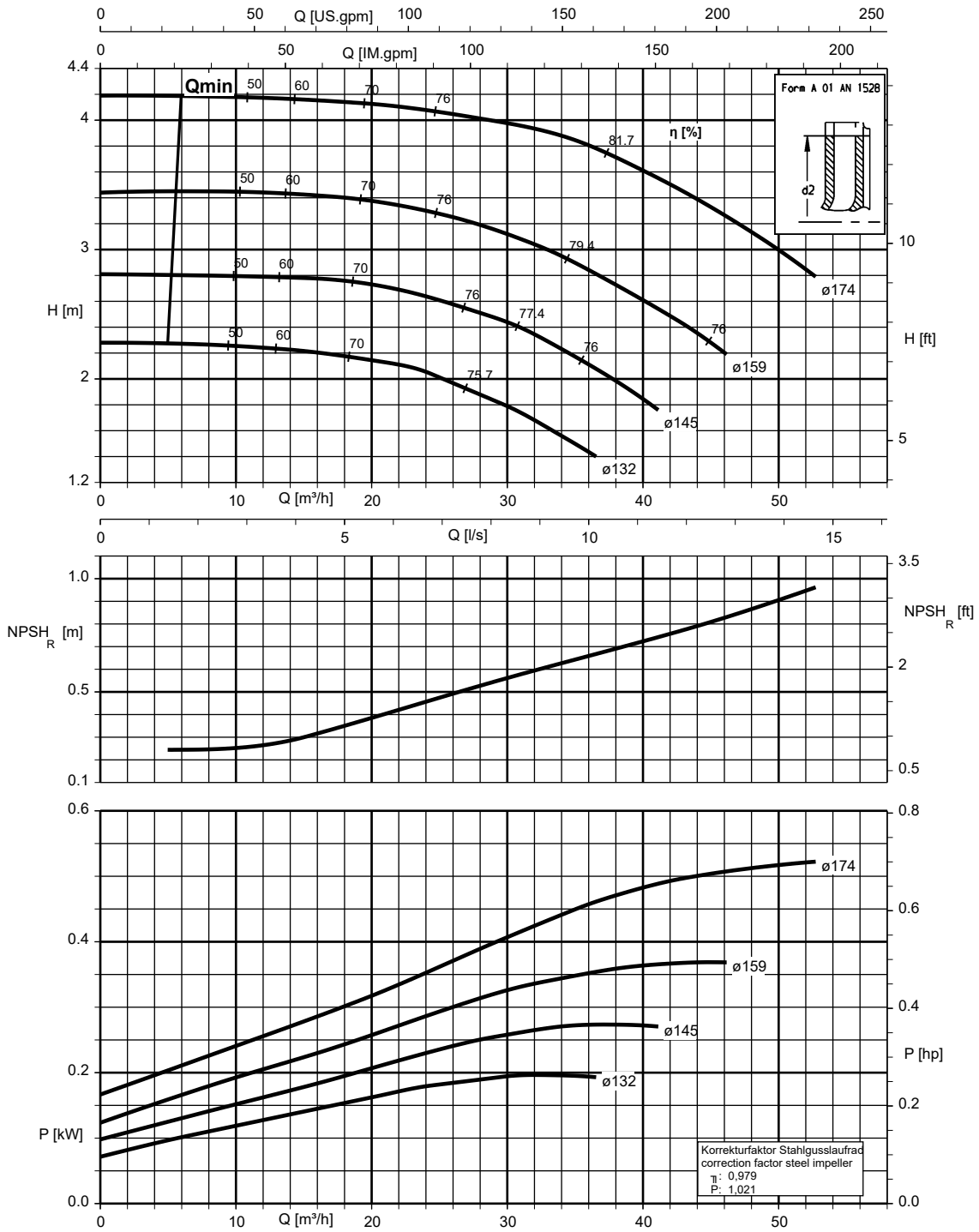

Vlet , Velta 080-065-200, n = 960 rpm

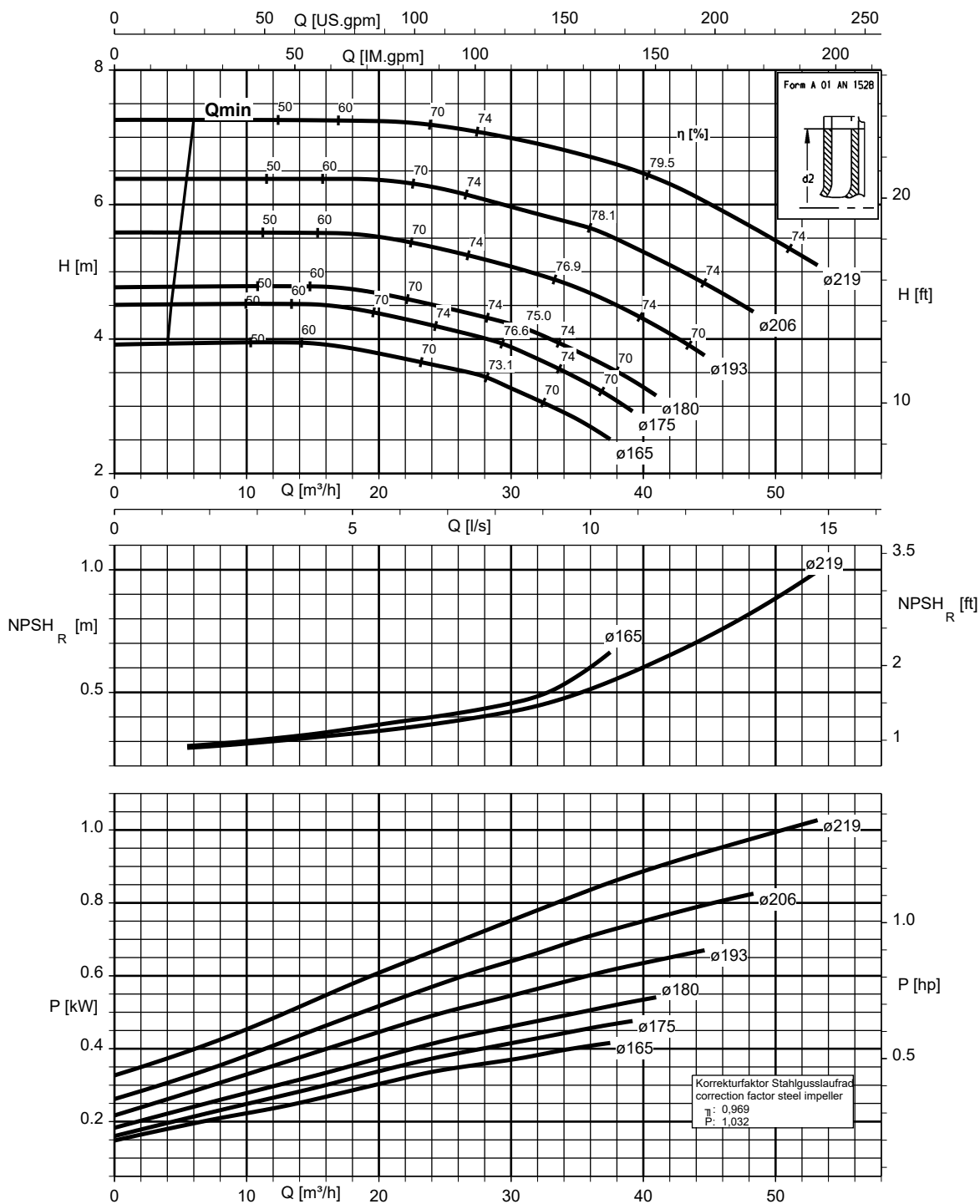

K1311.456/37/2

Vlet, Velta 080-065-250, n = 960 rpm

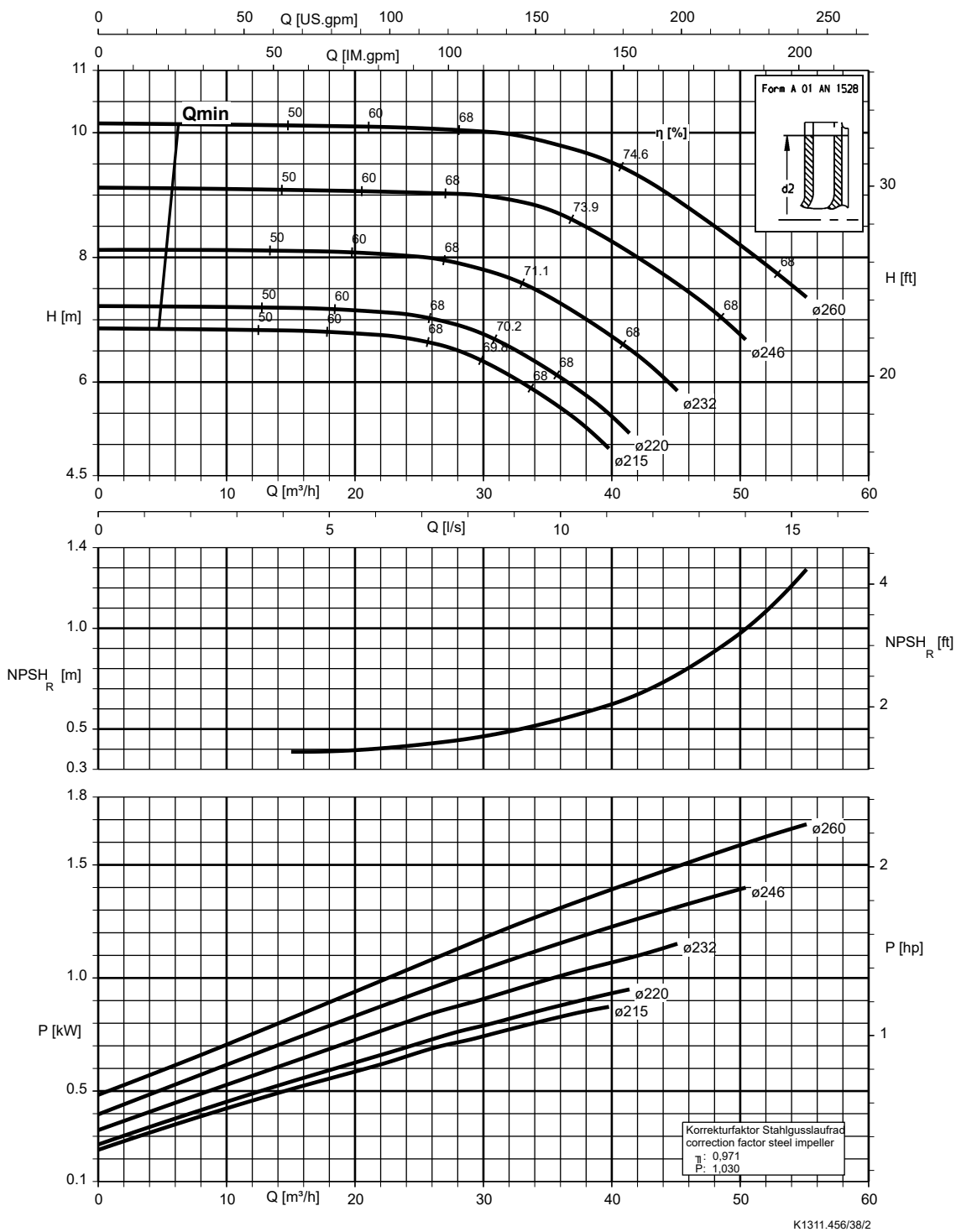

Vlet , Velta 080-065-315, n = 960 rpm

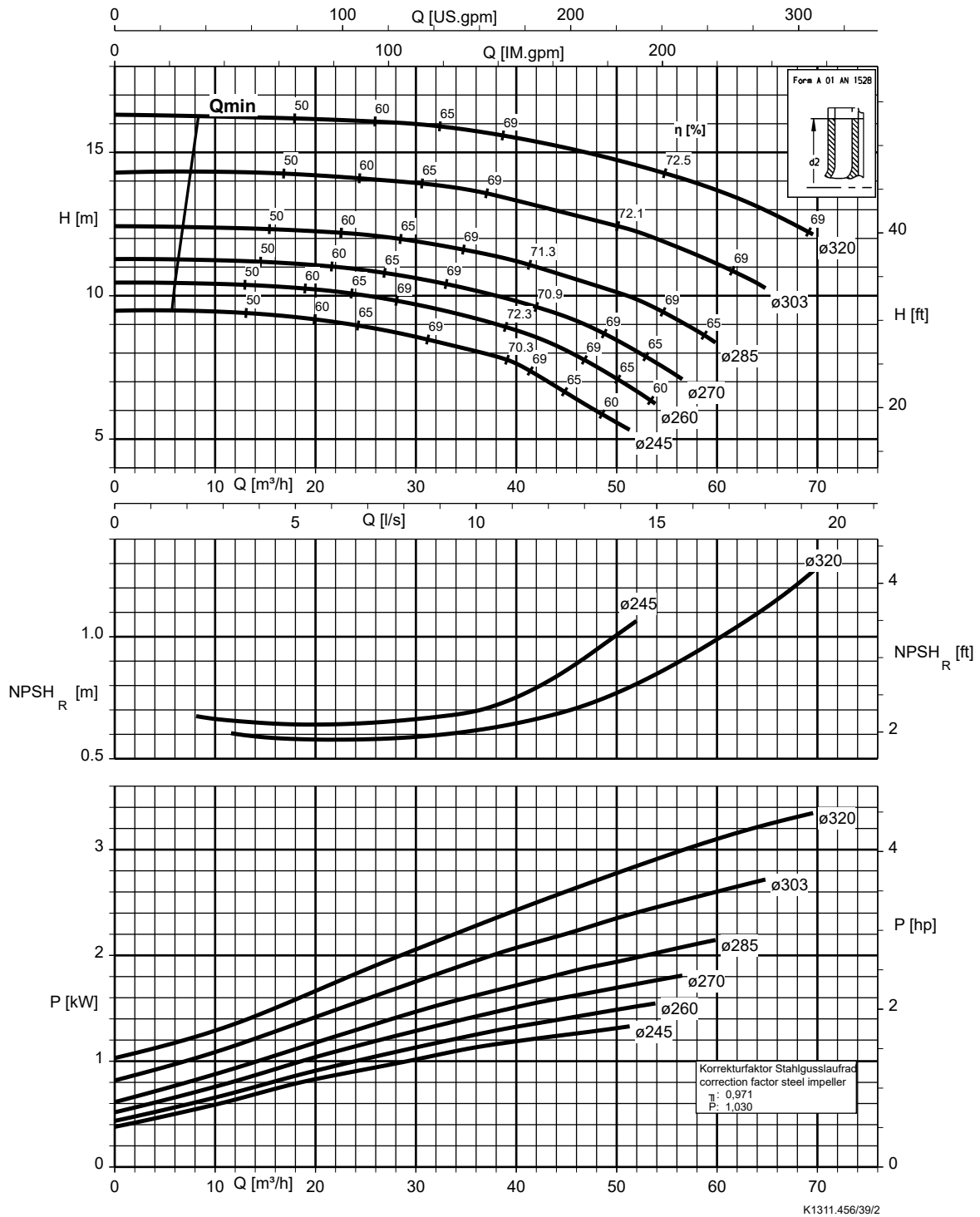

Vlet , Velta 100-080-160, n = 960 rpm

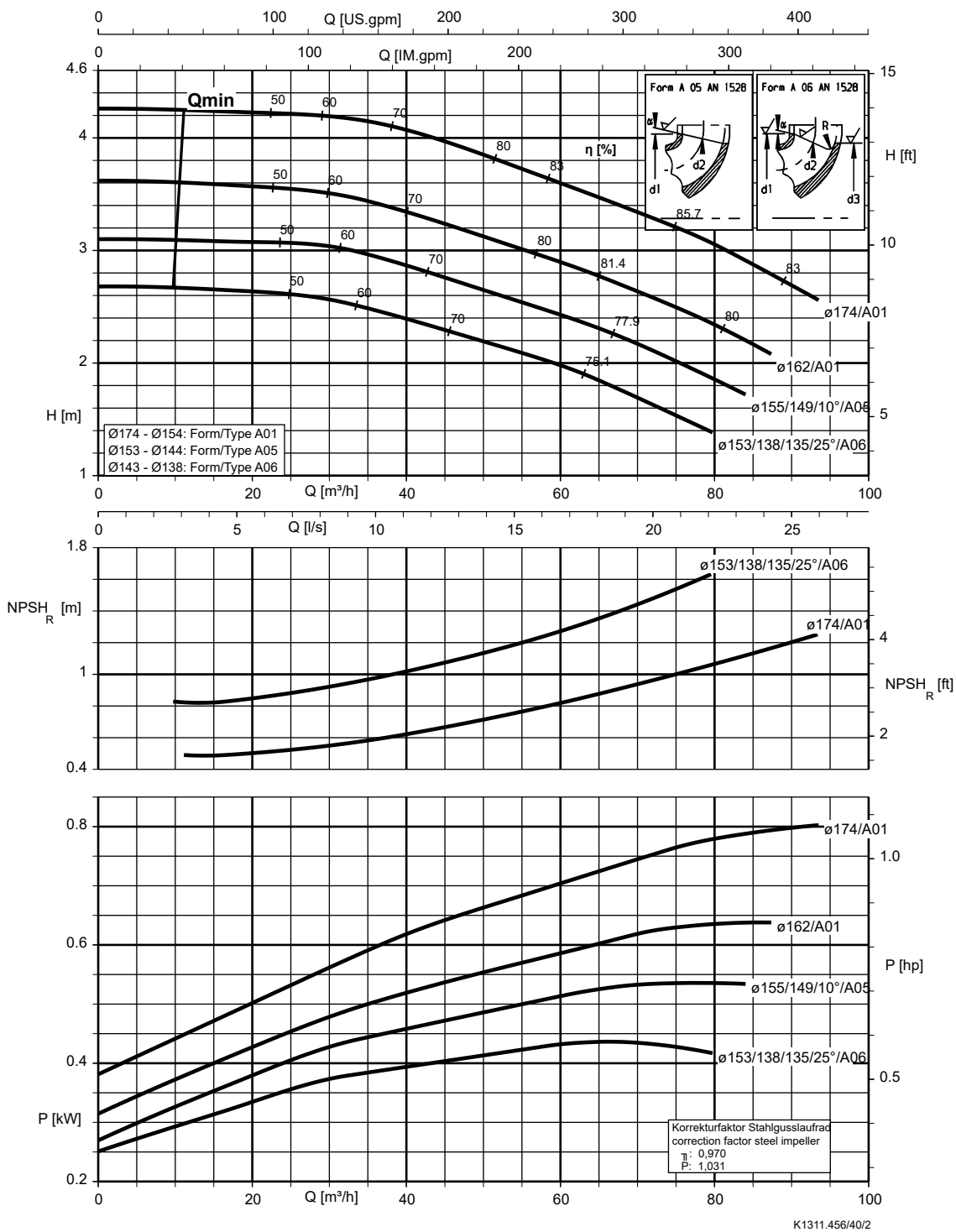

K1311.456/40/2



Vlet , Velta 100-080-200, n = 960 rpm

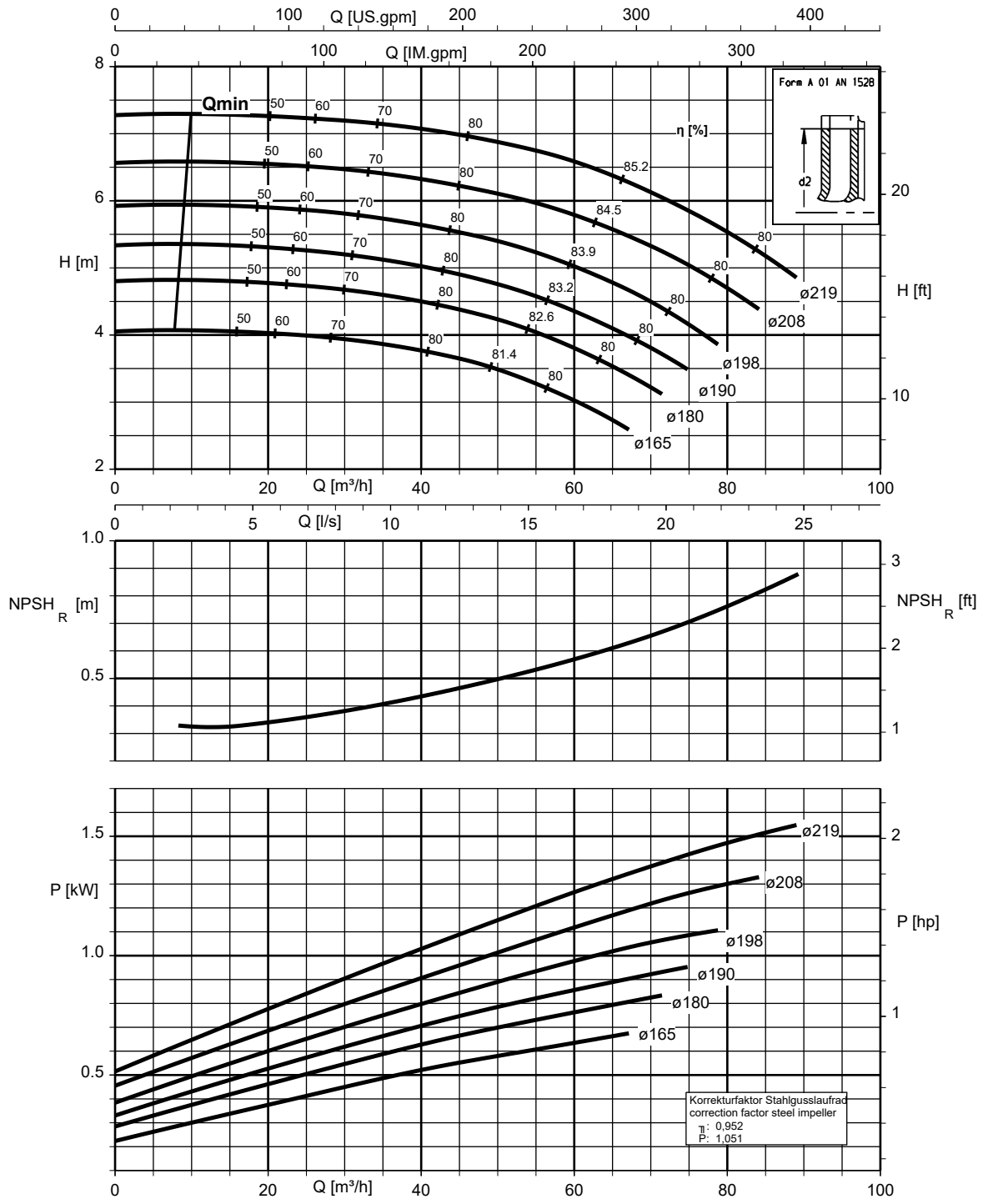

Vlet, Velta 100-080-250, n = 960 rpm

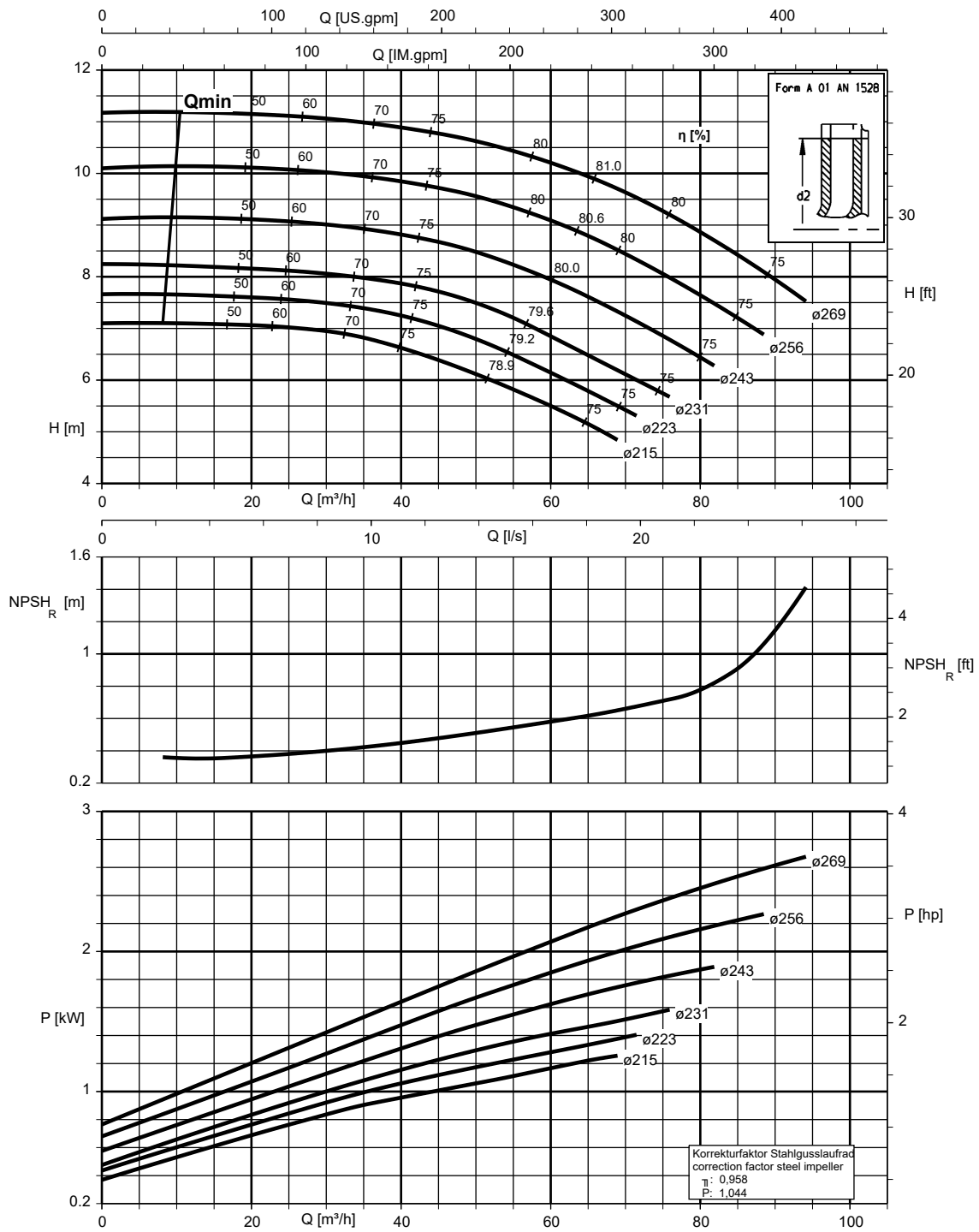

K1311.456/42/2

Vlet , Velta 100-080-315, n = 960 rpm

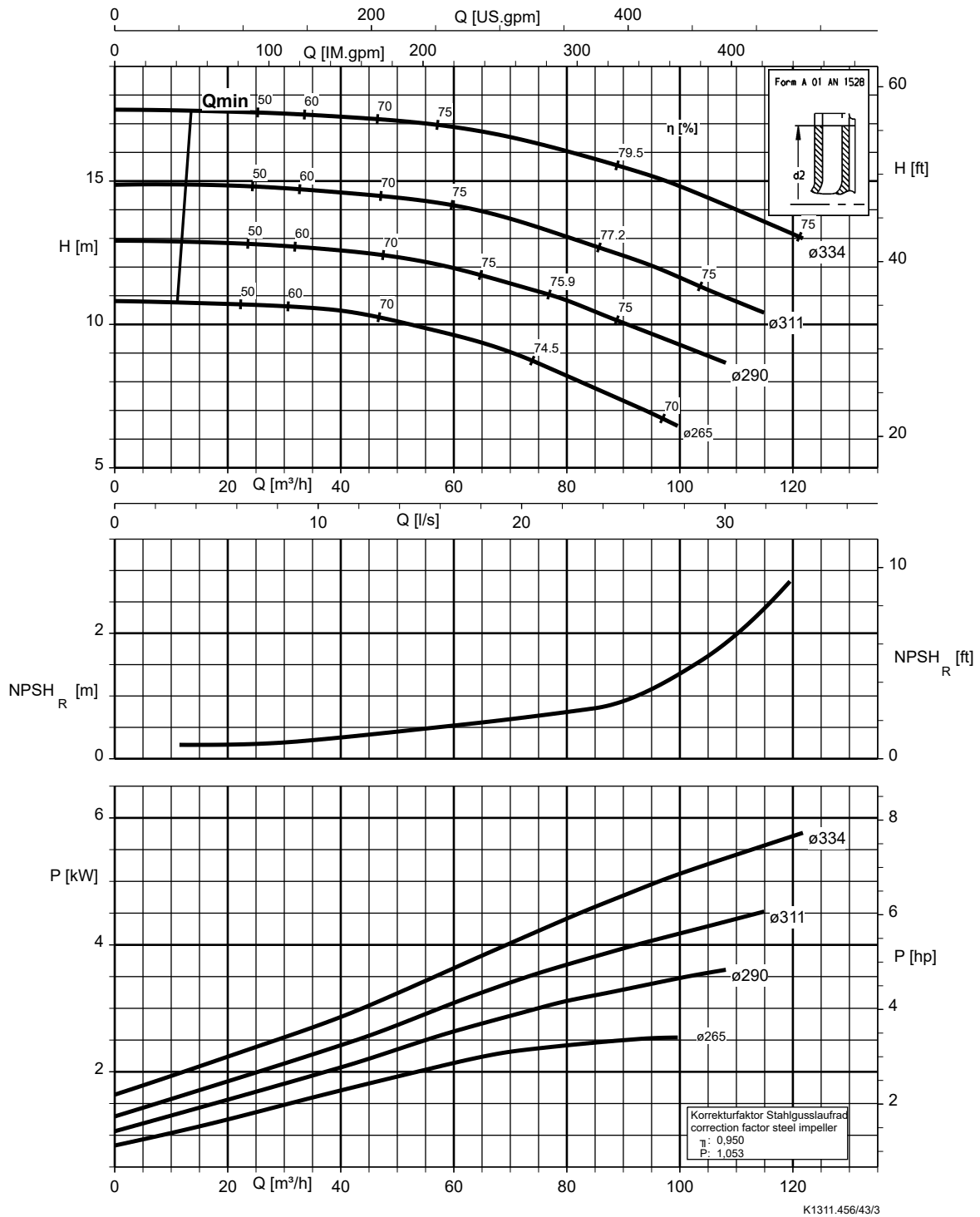

Vlet , Velta 100-080-400, n = 960 rpm

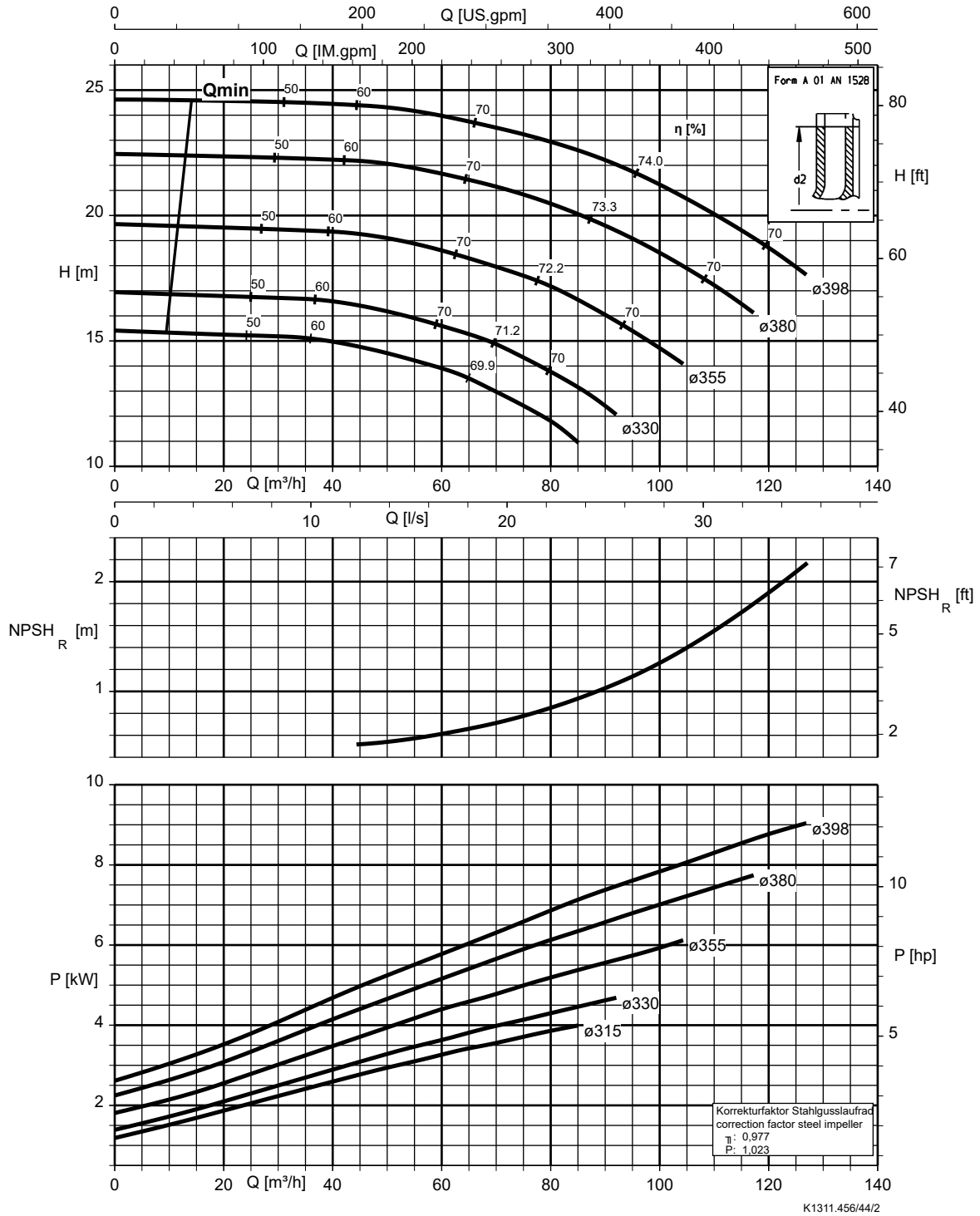

Vlet , Velta 125-100-160, n = 960 rpm

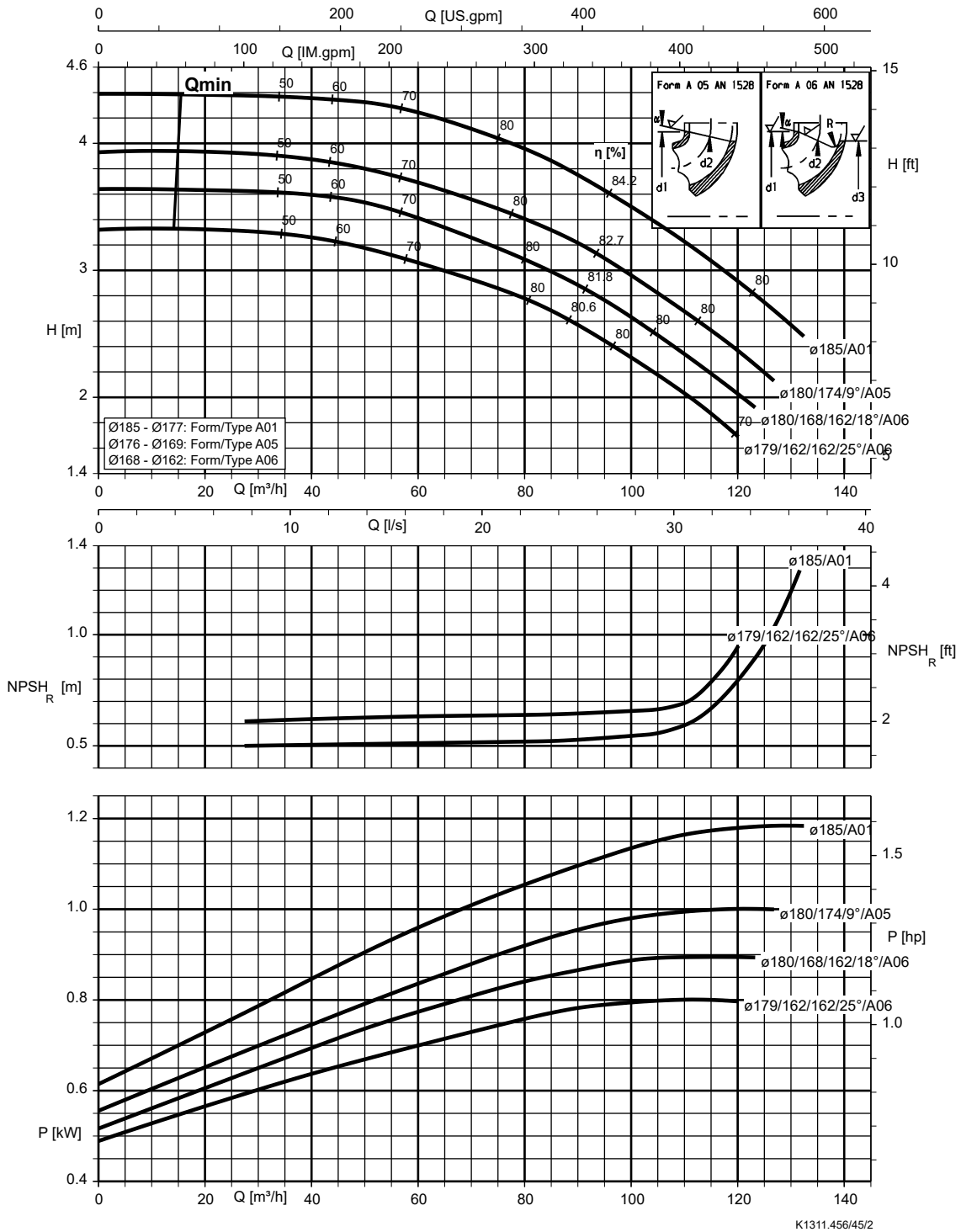

K1311.456/45/2

Vlet , Velta 125-100-200, n = 960 rpm

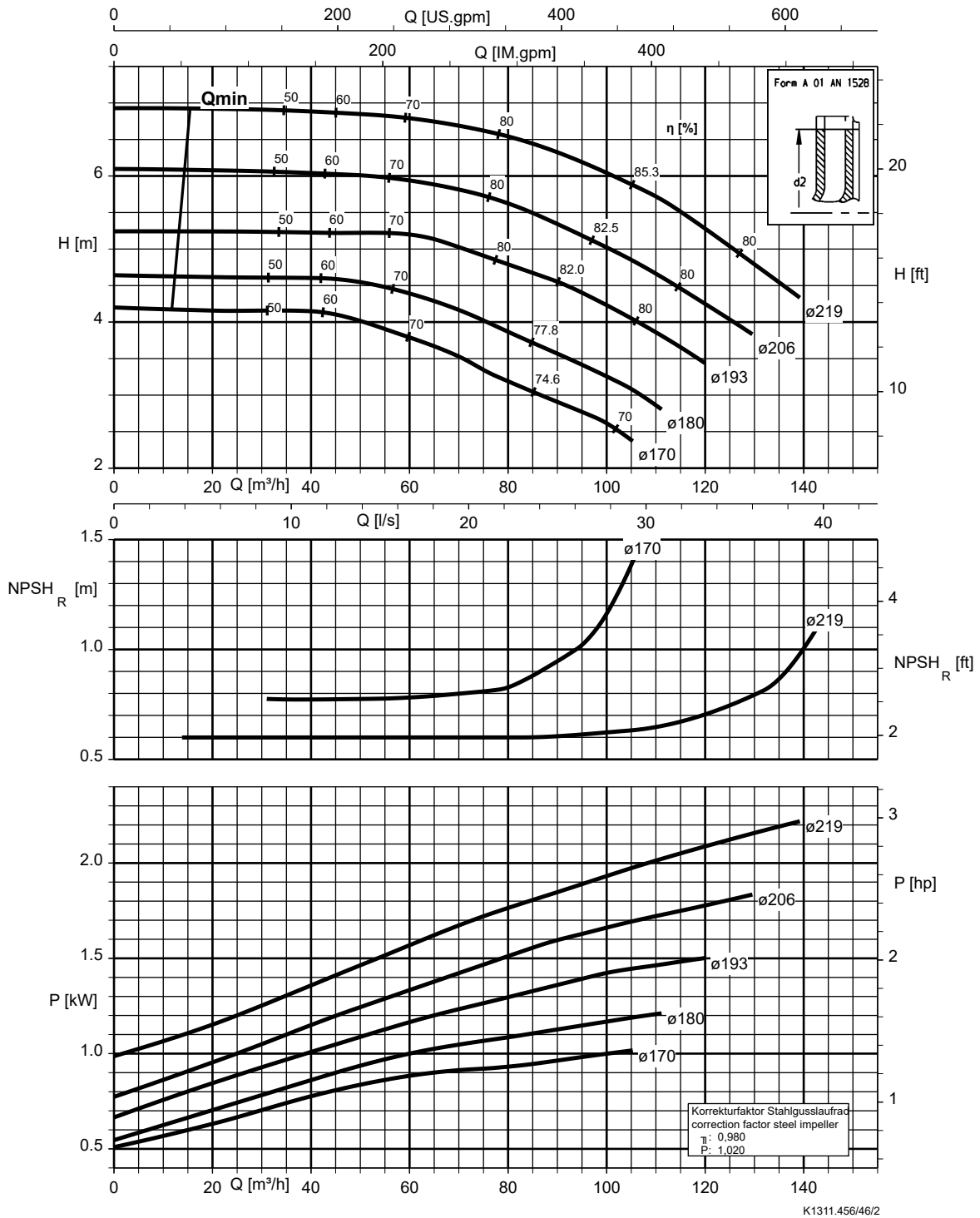

Vlet , Velta 125-100-250, n = 960 rpm

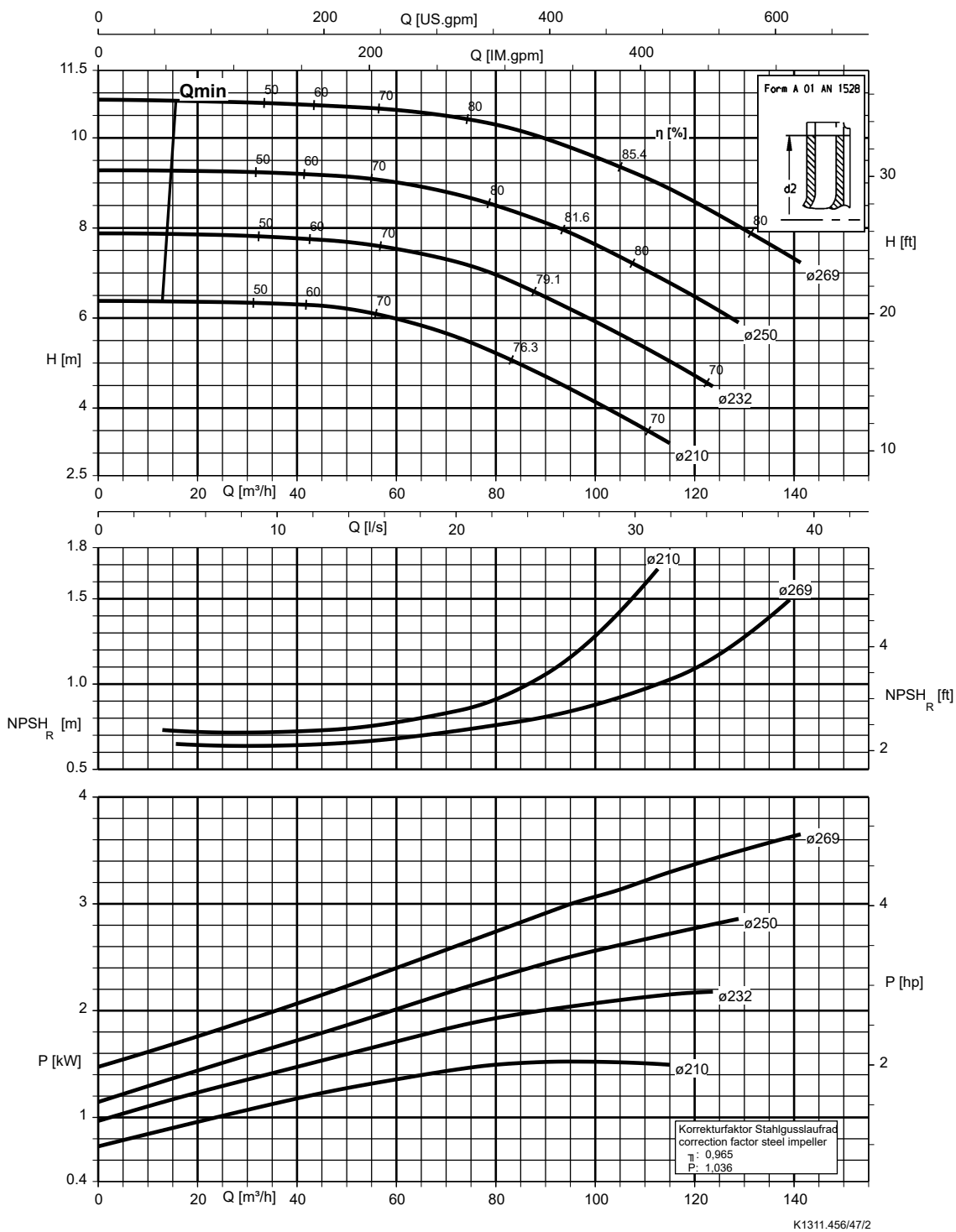

Vlet , Velta 125-100-315, n = 960 rpm

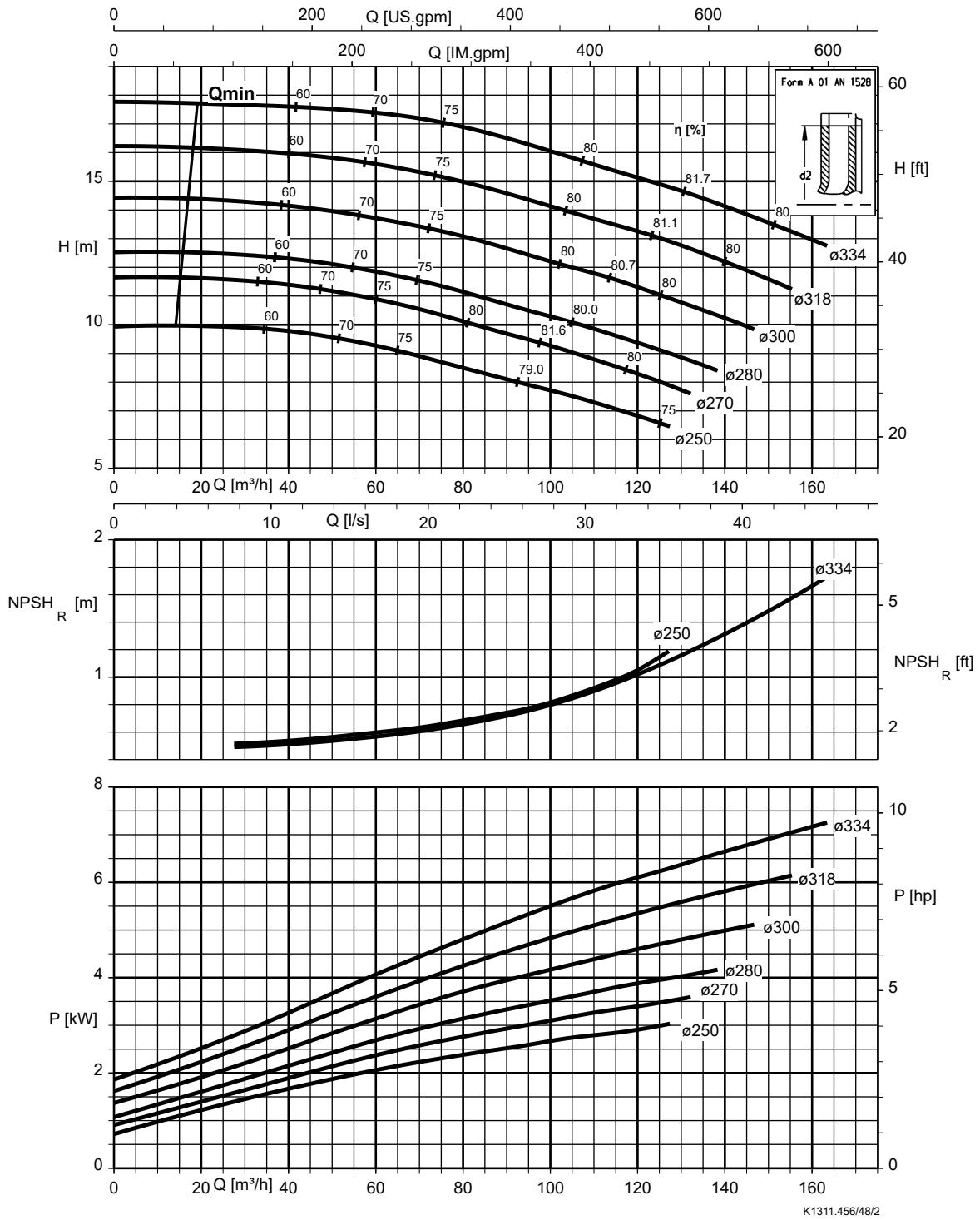



Vlet , Velta 125-100-400, n = 960 rpm

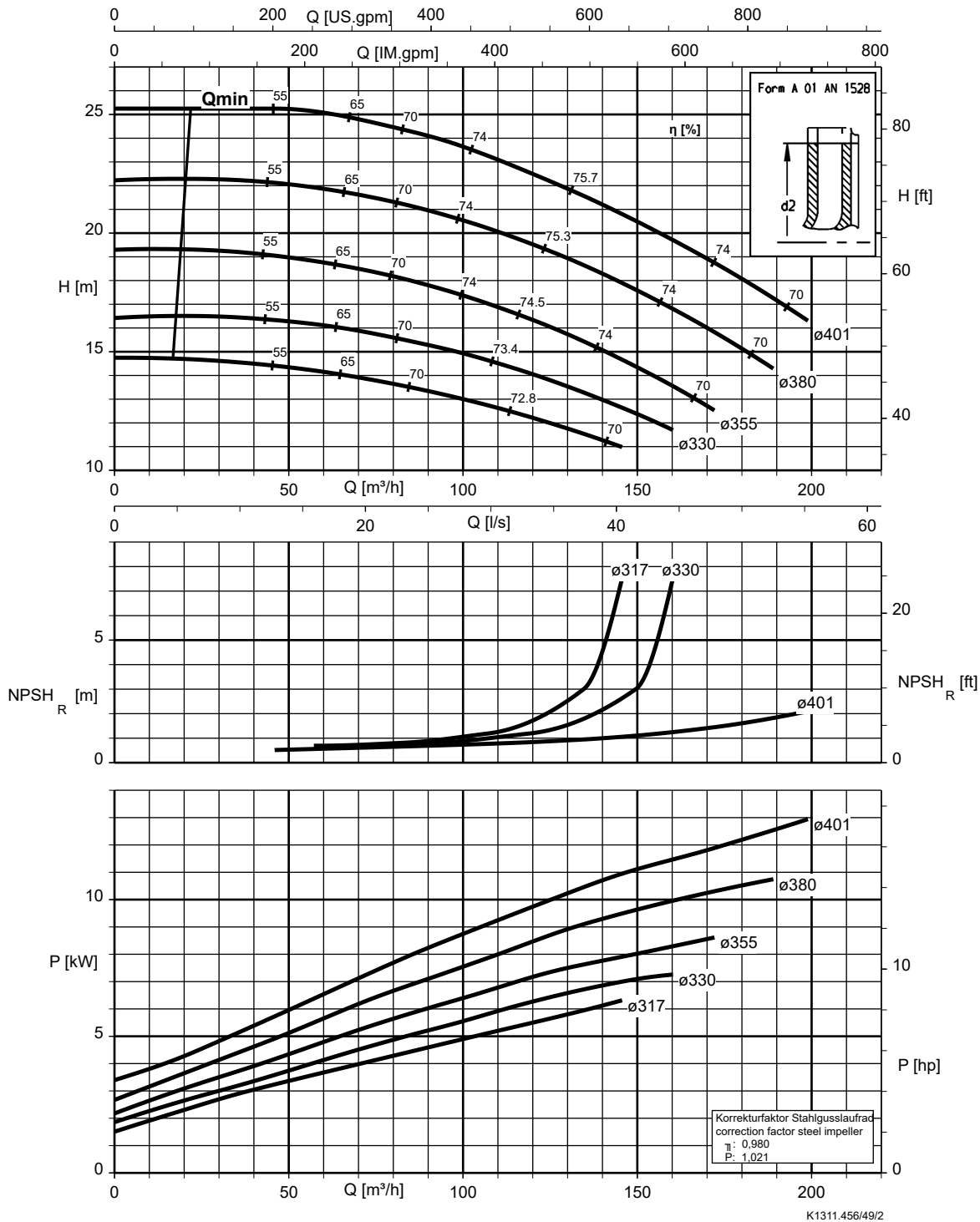

Vlet , Velta 150-125-200, n = 960 rpm

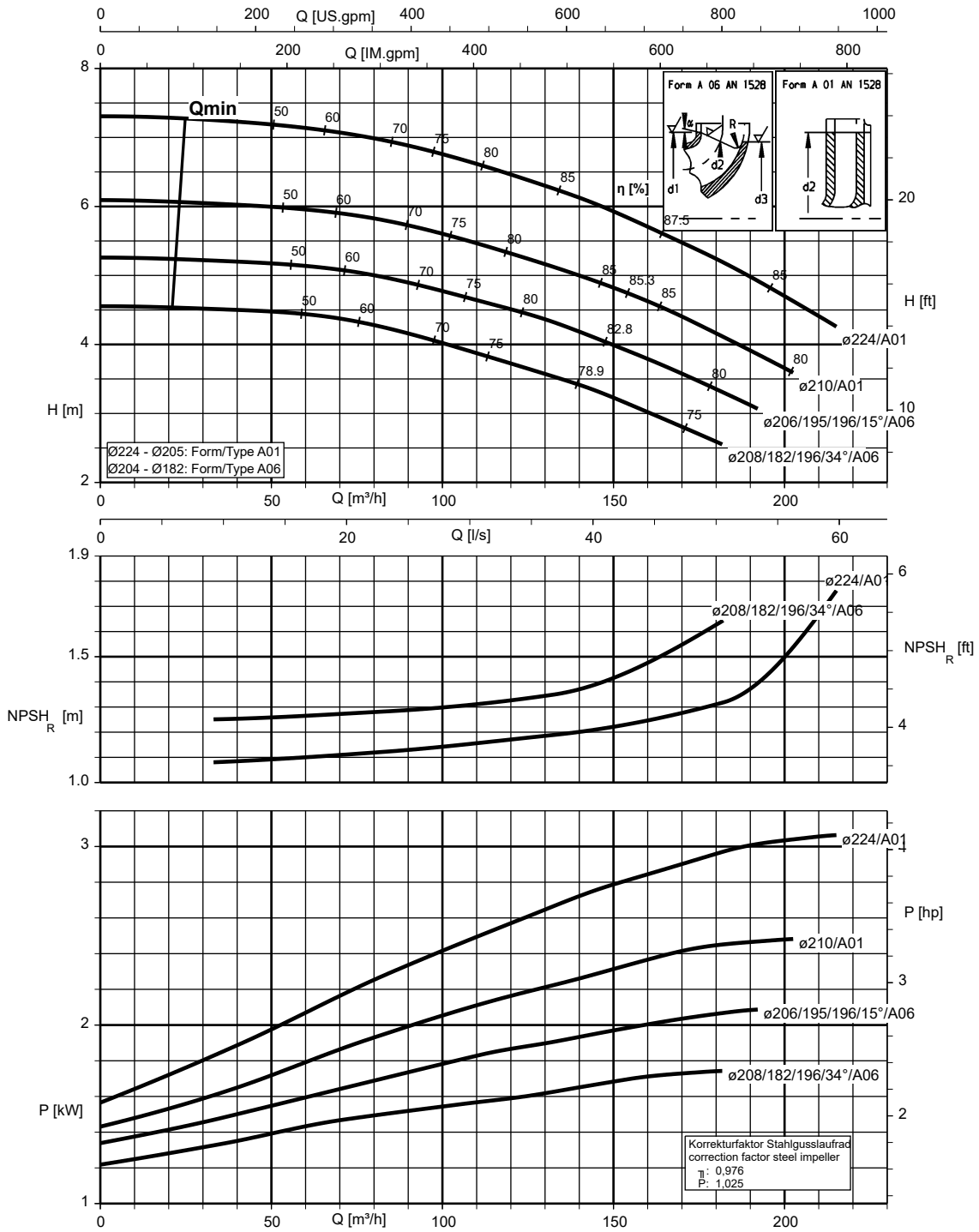

K1311.456/50/2

Vlet , Velta 150-125-250, n = 960 rpm

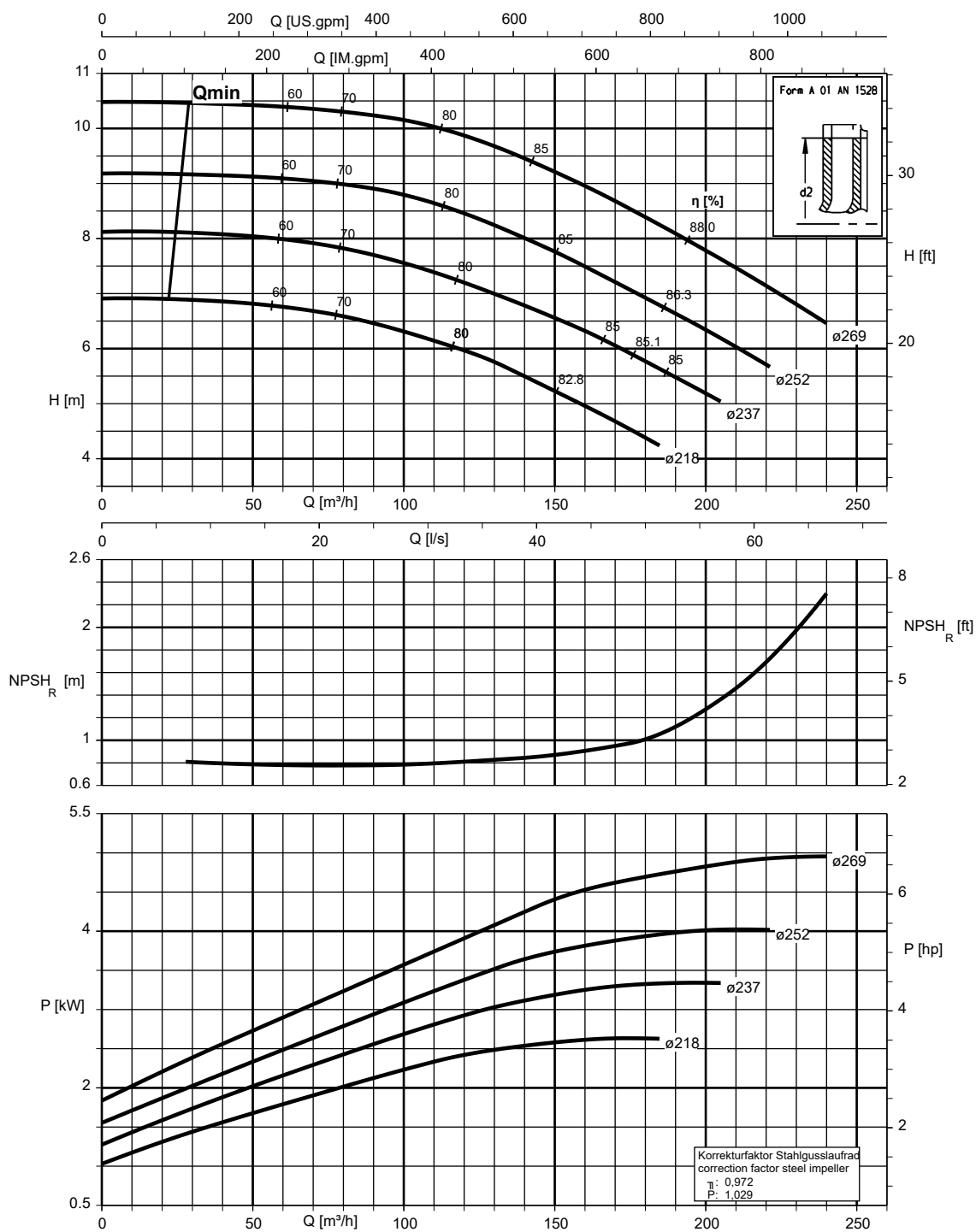

K1311.456/51/2

Vlet , Velta150-125-315, n = 960 rpm

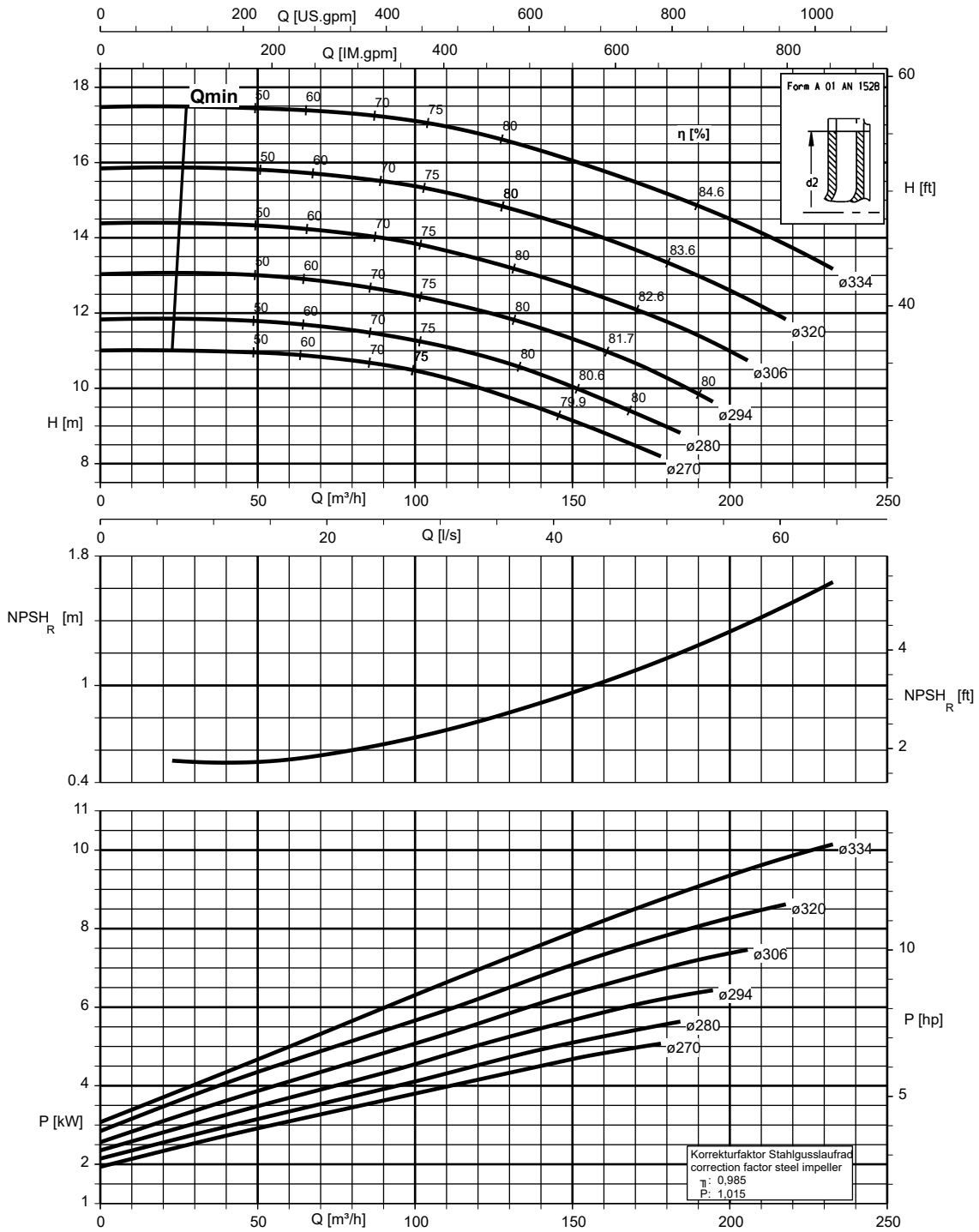

K1311.456/52/2

Vlet , Velta 150-125-400, n = 960 rpm

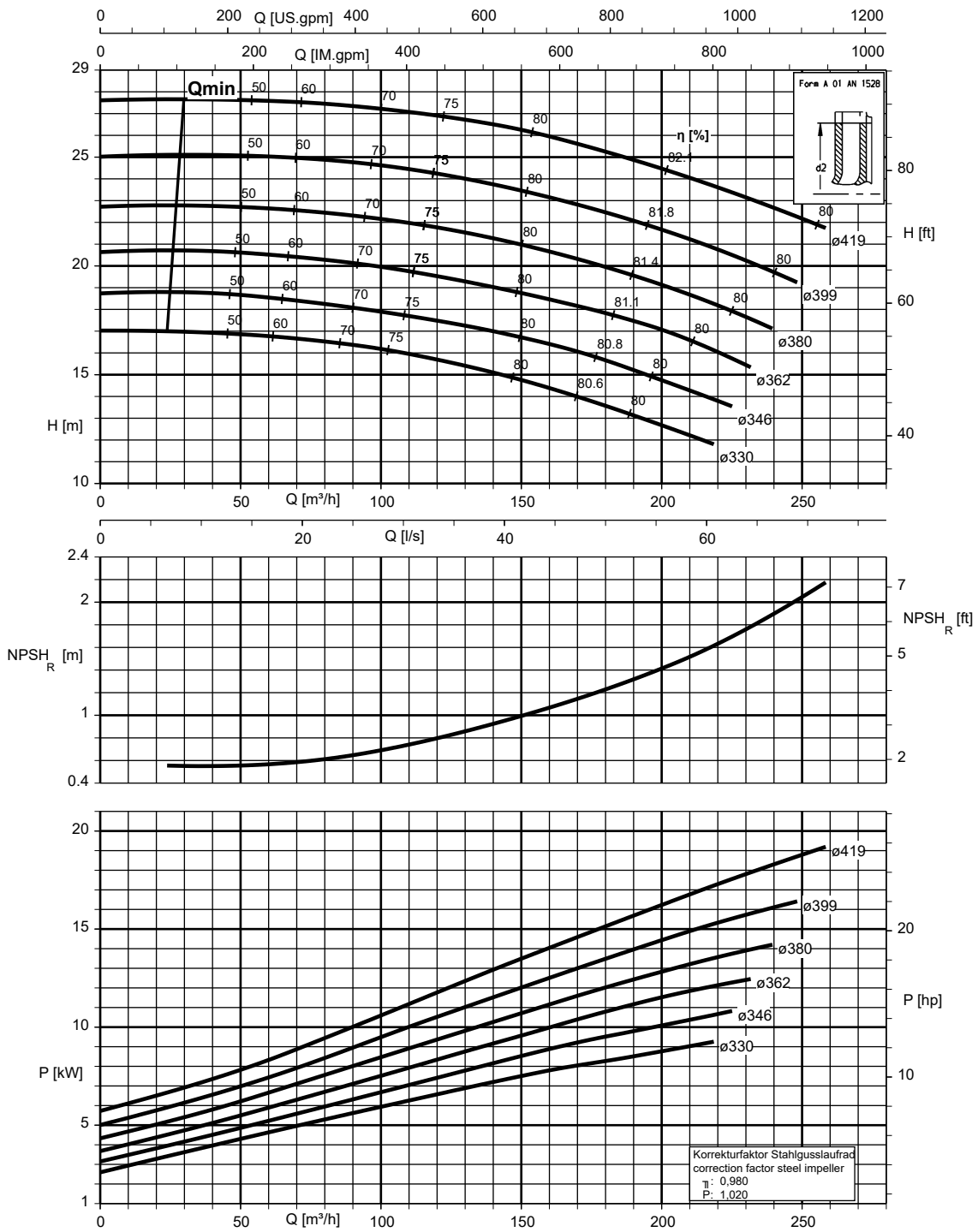

K1311.456/53/2

Vlet , Velta 150-125-510, n = 960 rpm

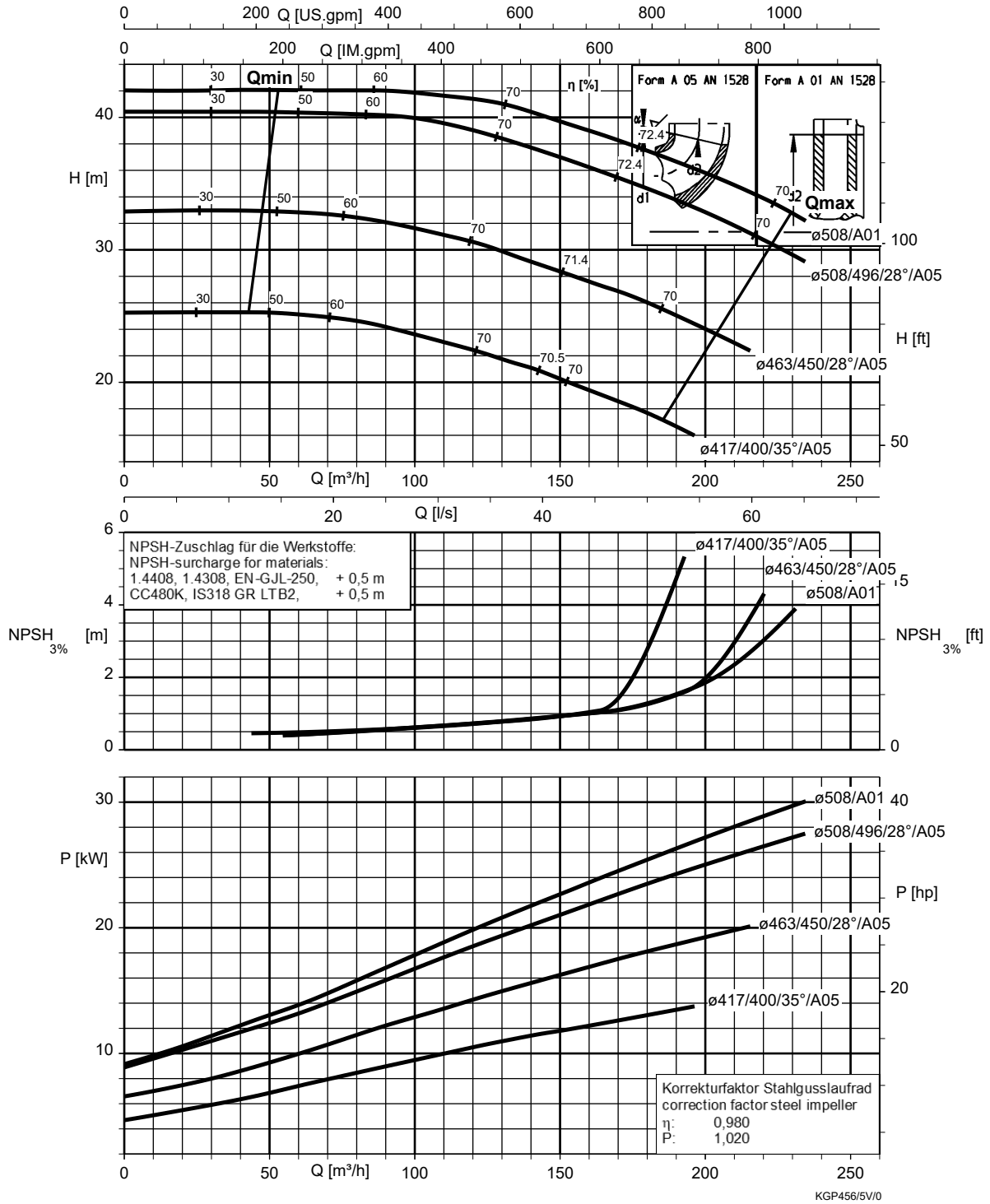

Vlet , Velta 200-150-200, n = 960 rpm

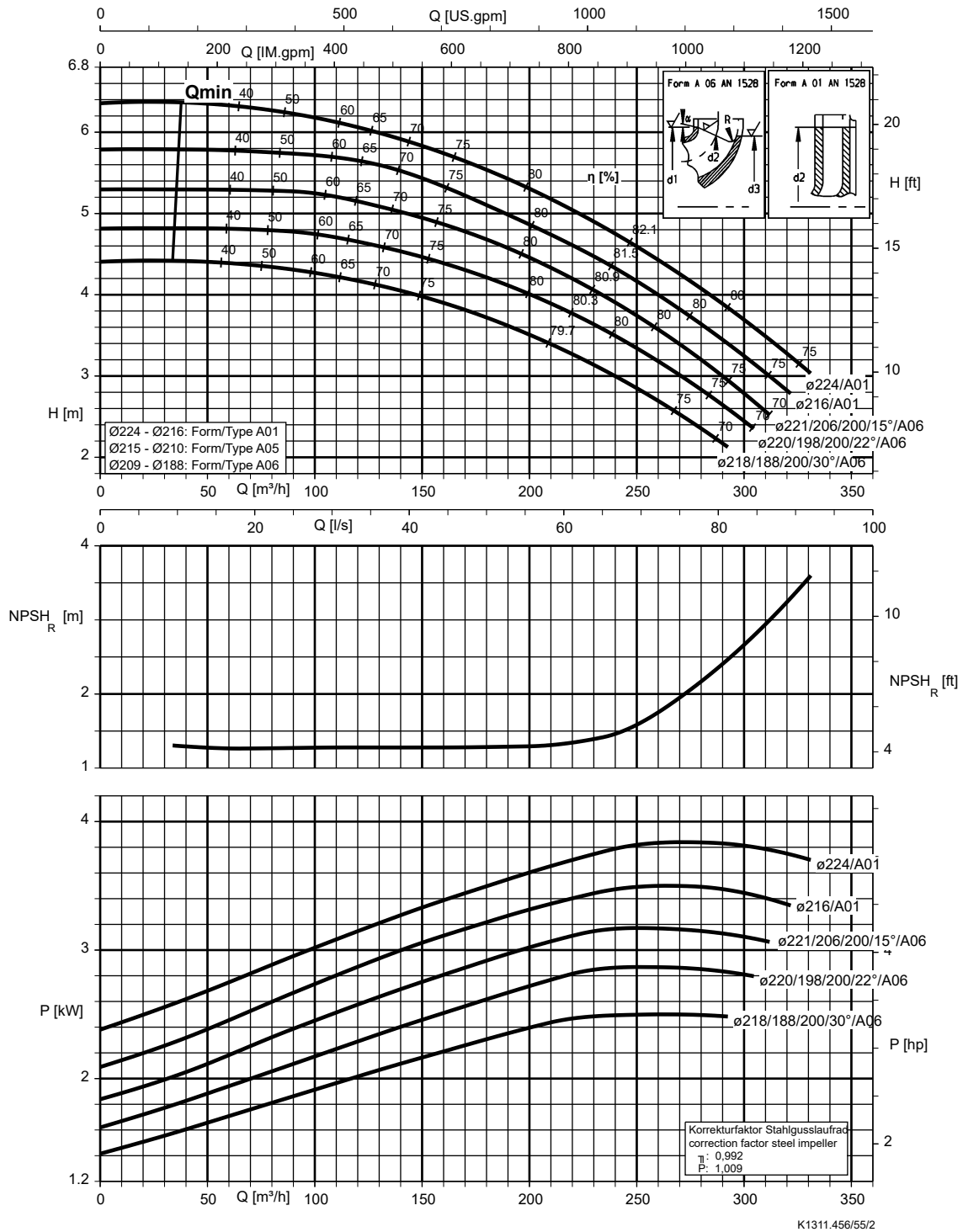

K1311.456/55/2

Vlet , Velta 200-150-250, n = 960 rpm

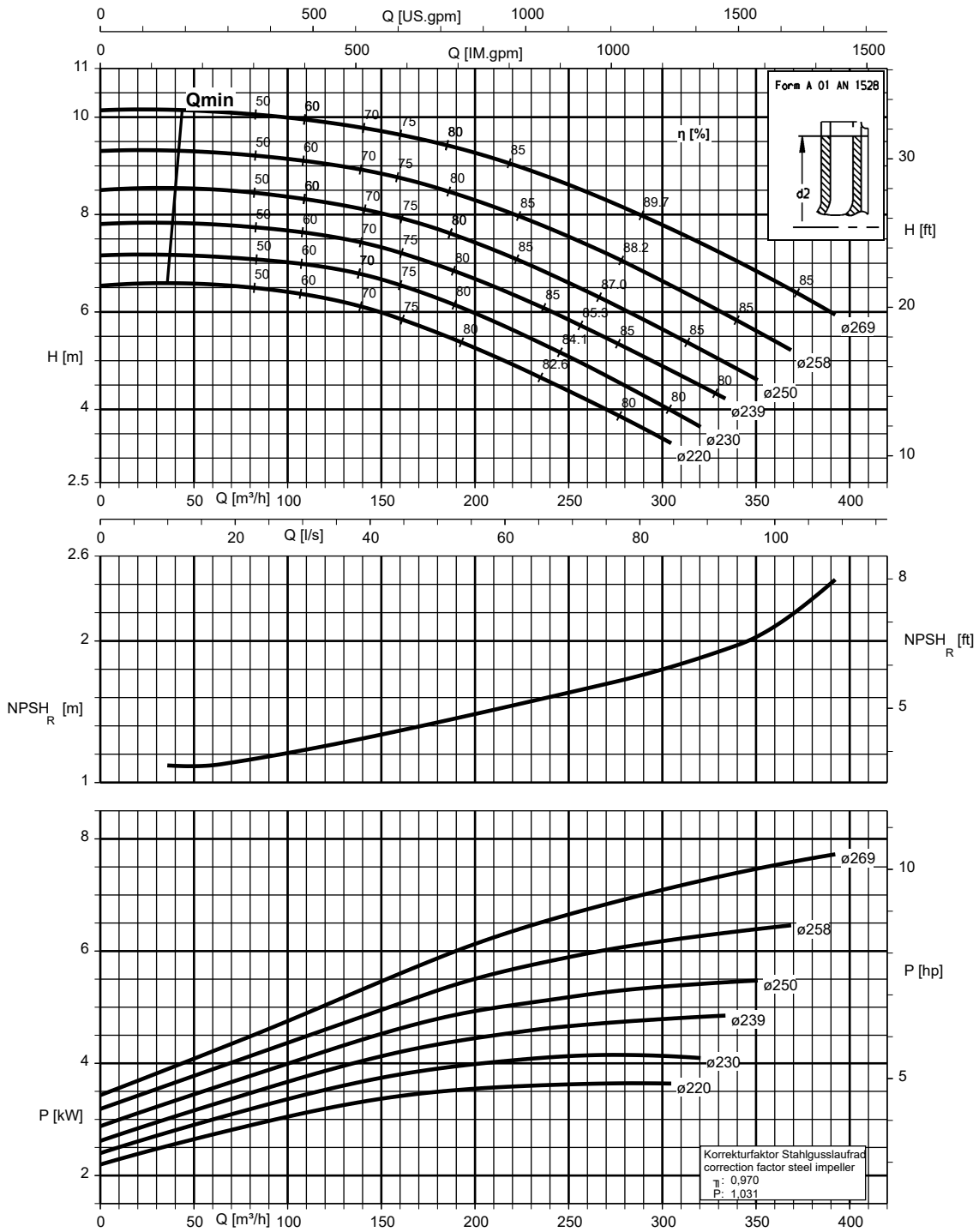

K1311.456/56/2



Vlet , Velta 200-150-315, n = 960 rpm

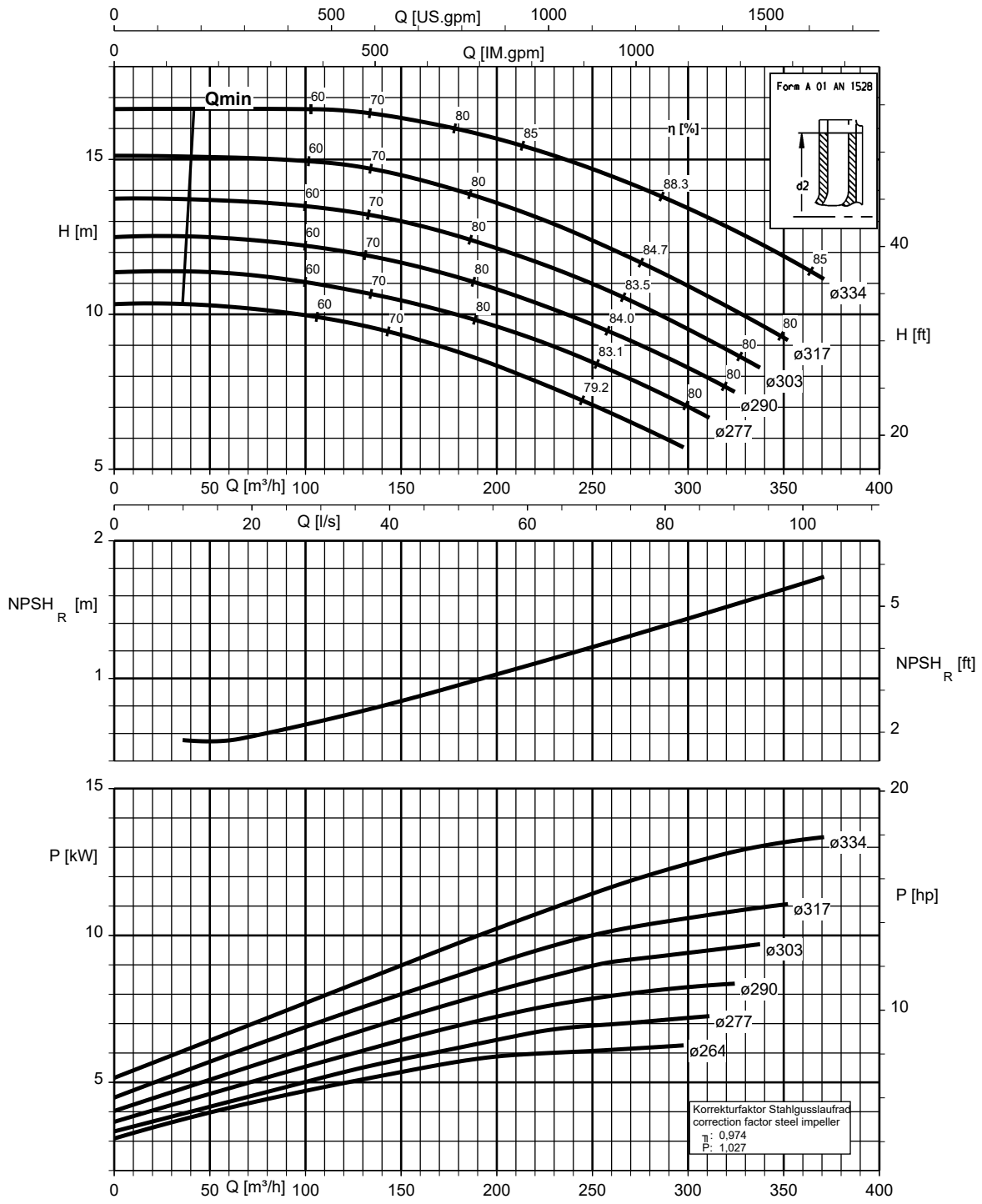

Vlet , Velta 200-150-400, n = 960 rpm

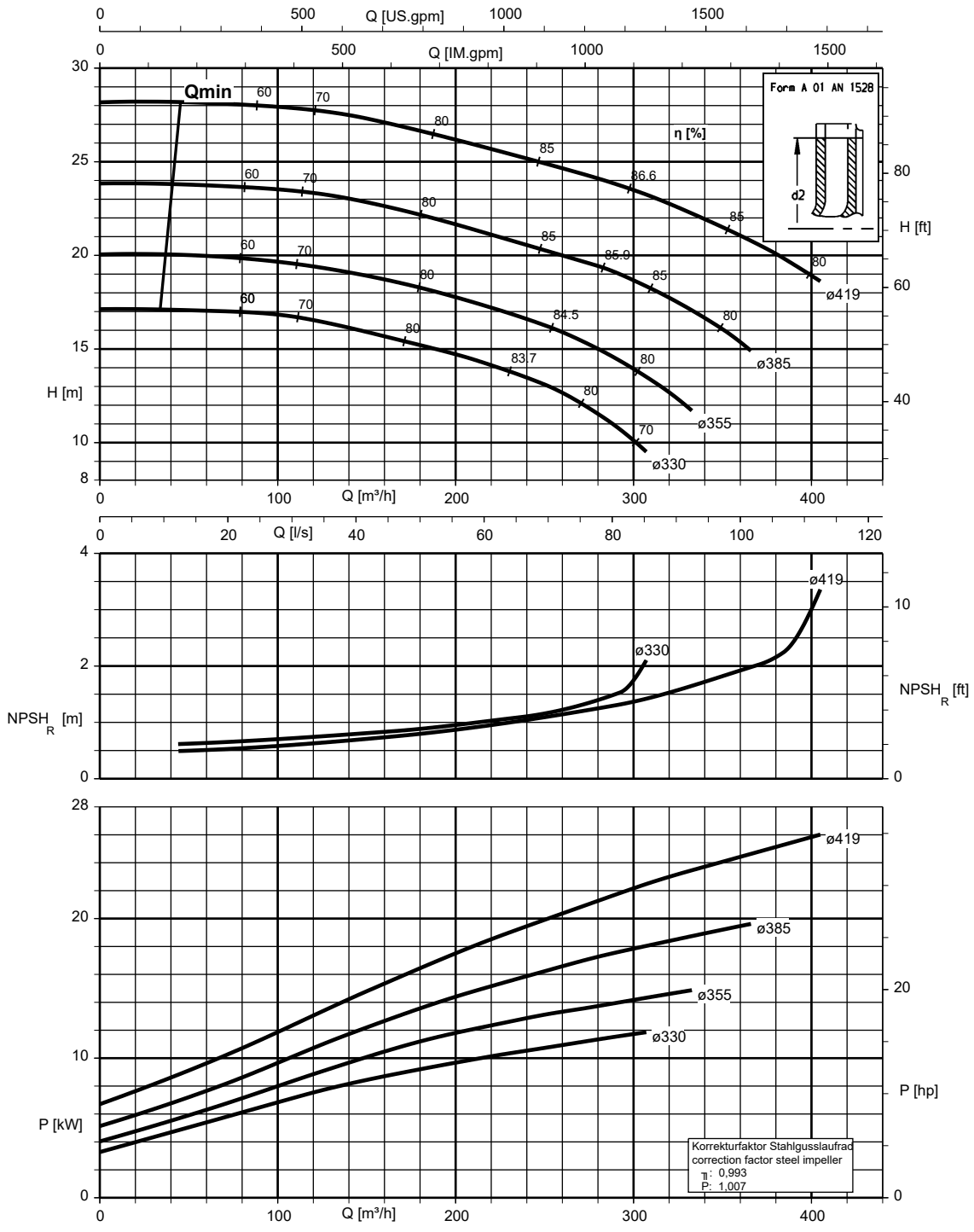

Vlet , Velta 200-150-510, n = 960 rpm

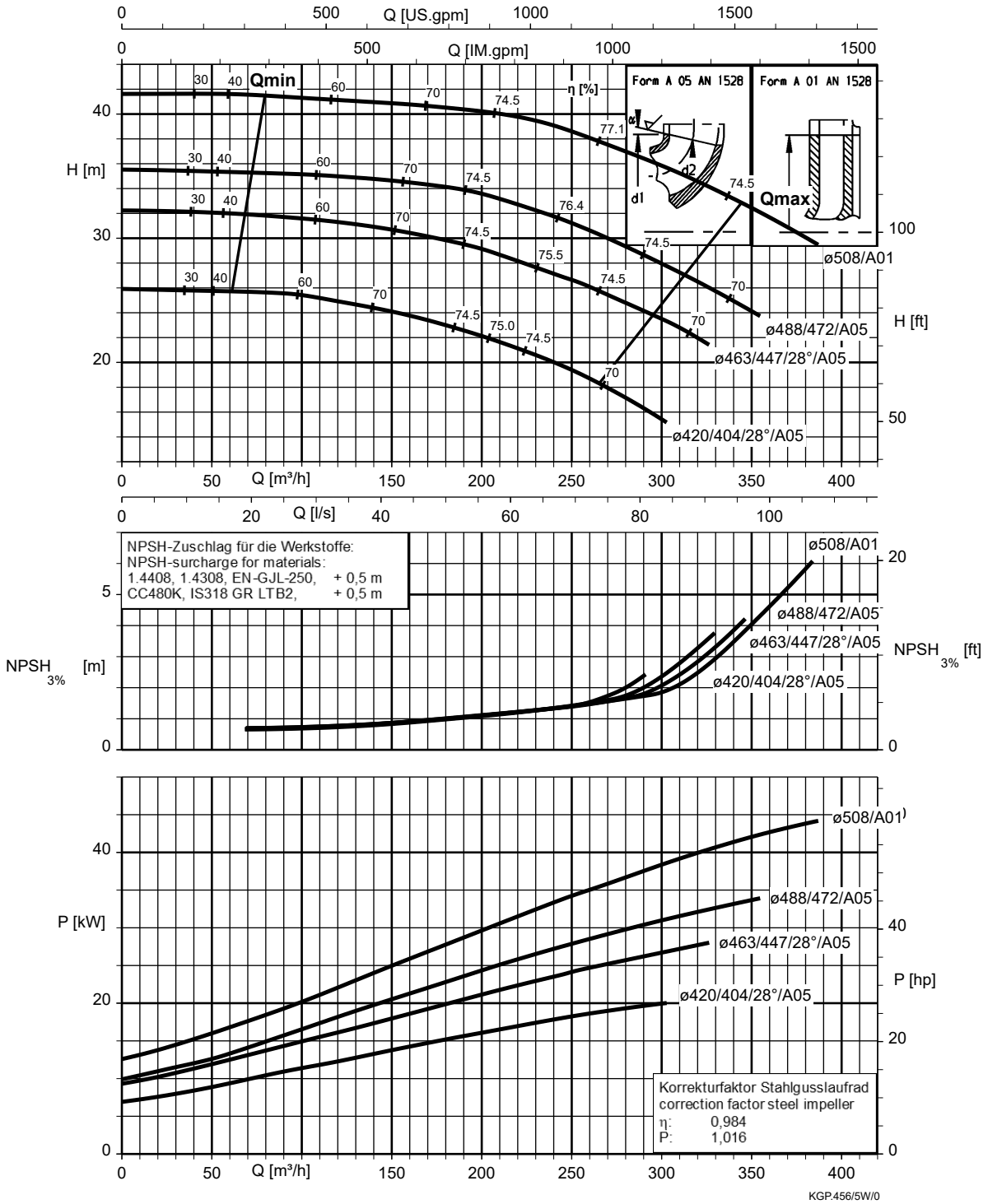

Vlet , Velta 200-200-250, n = 960 rpm

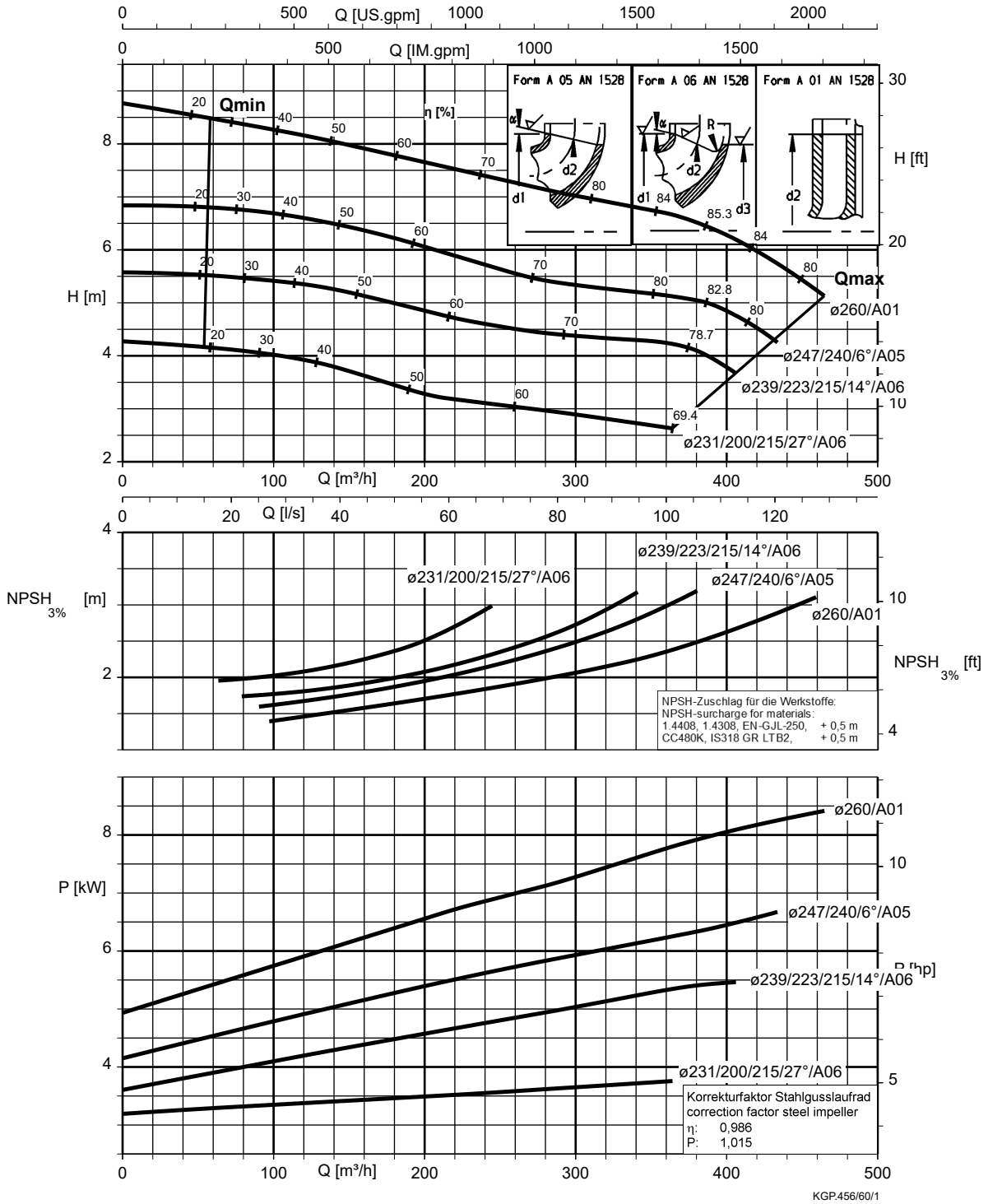

Vlet , Velta 250-200-275, n = 960 rpm

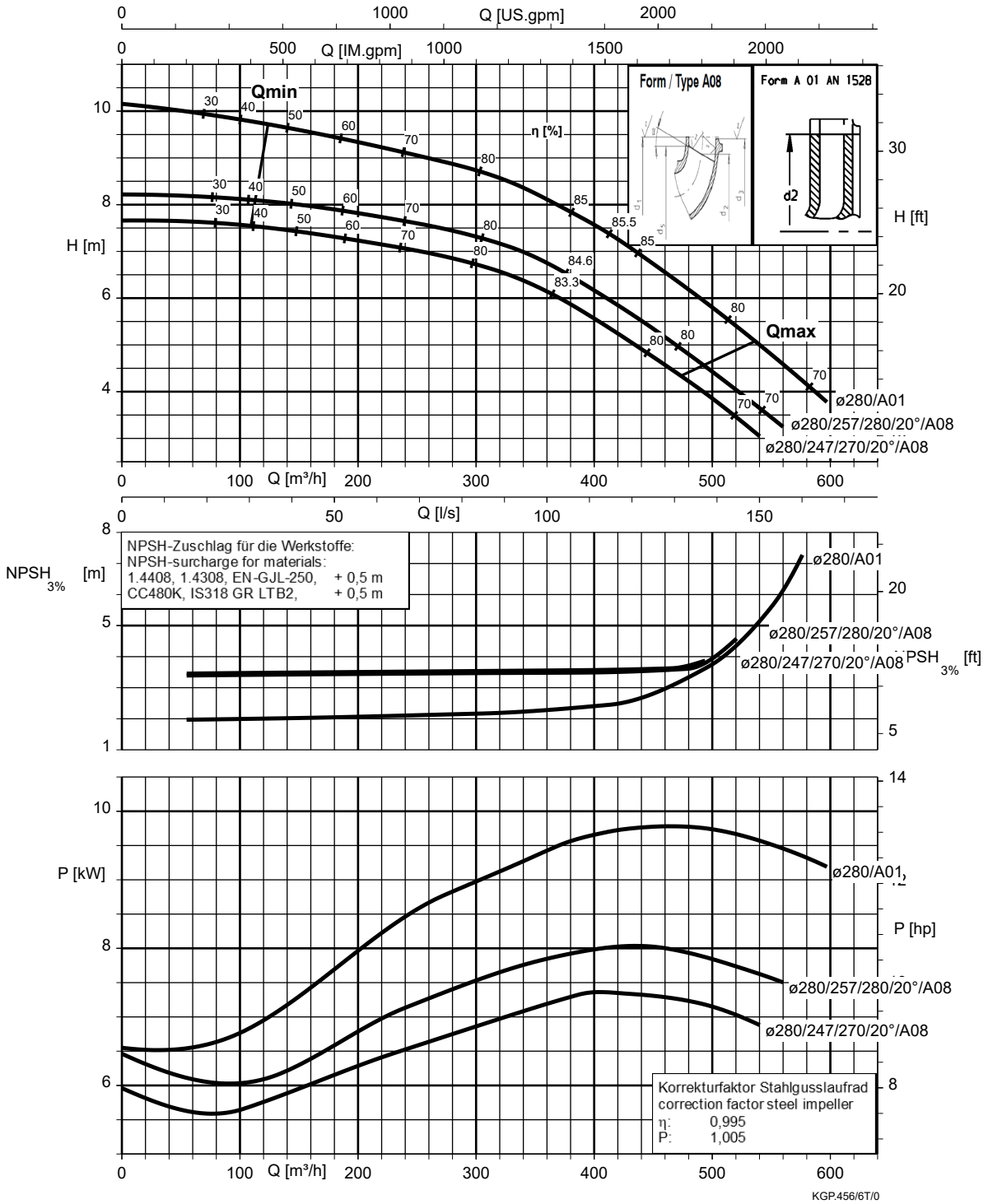

Vlet , Velta 250-200-320, n = 960 rpm

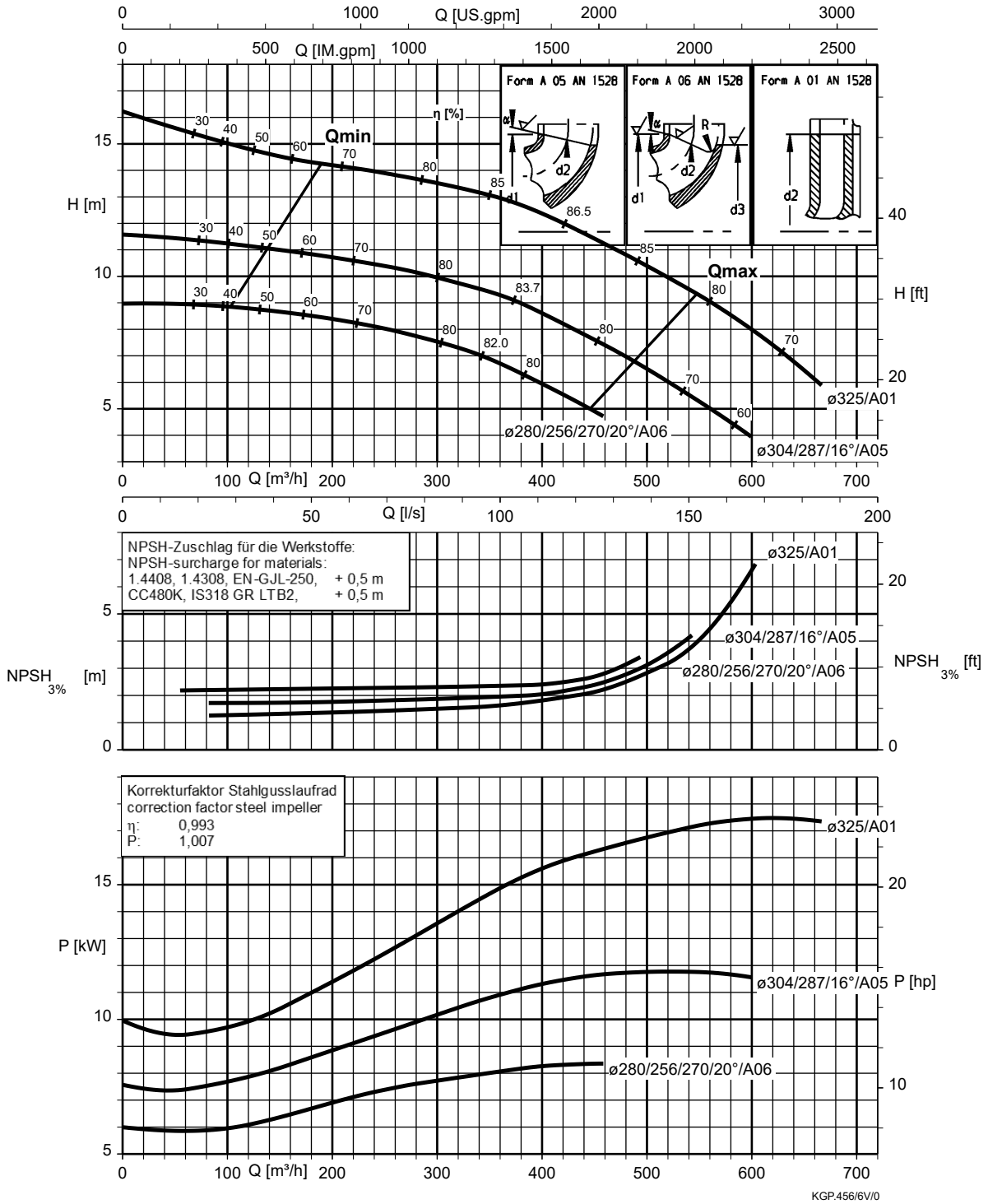

Vlet , Velta 250-200-375, n = 960 rpm

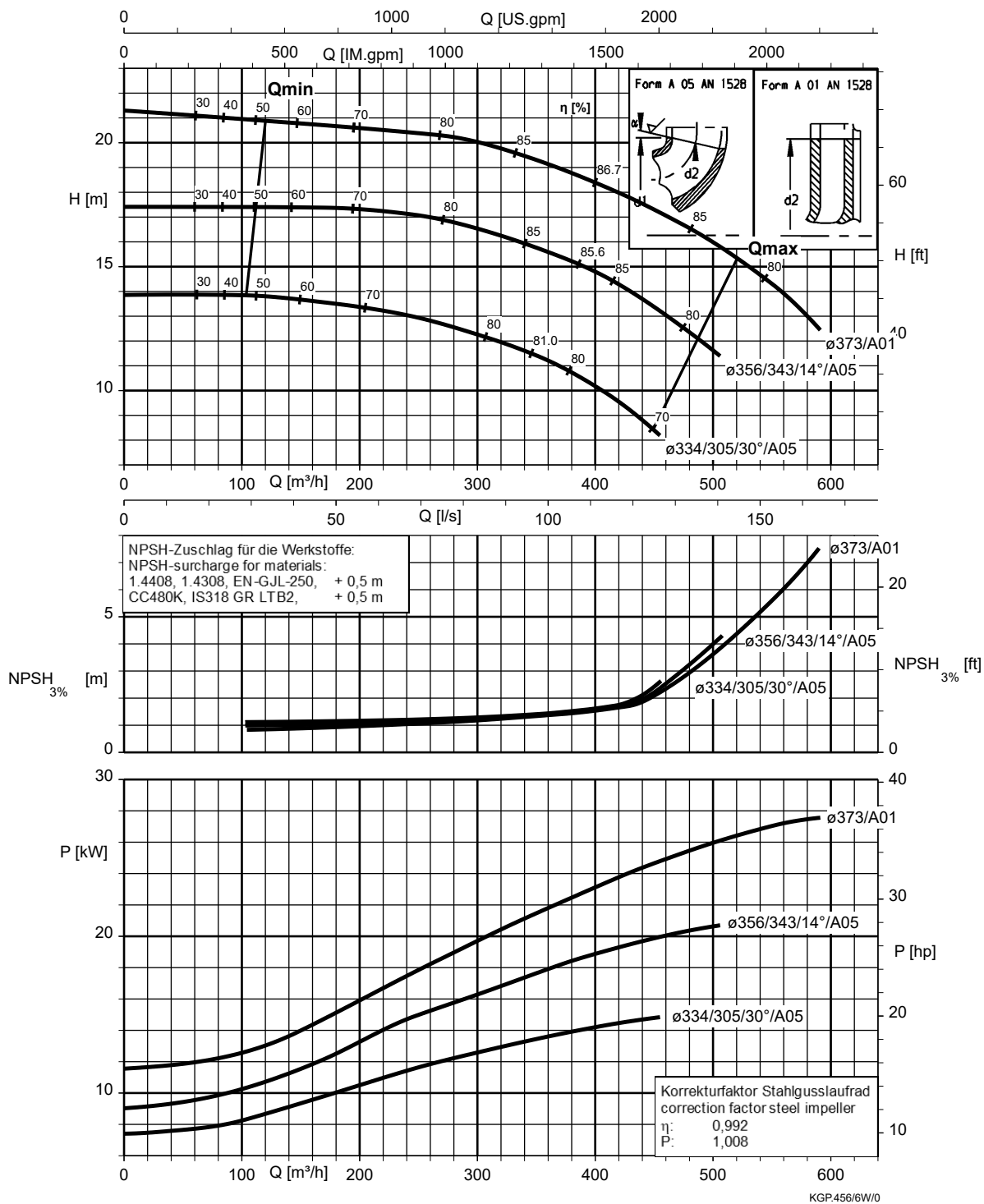

Vlet , Velta 250-200-435 , n = 960 rpm

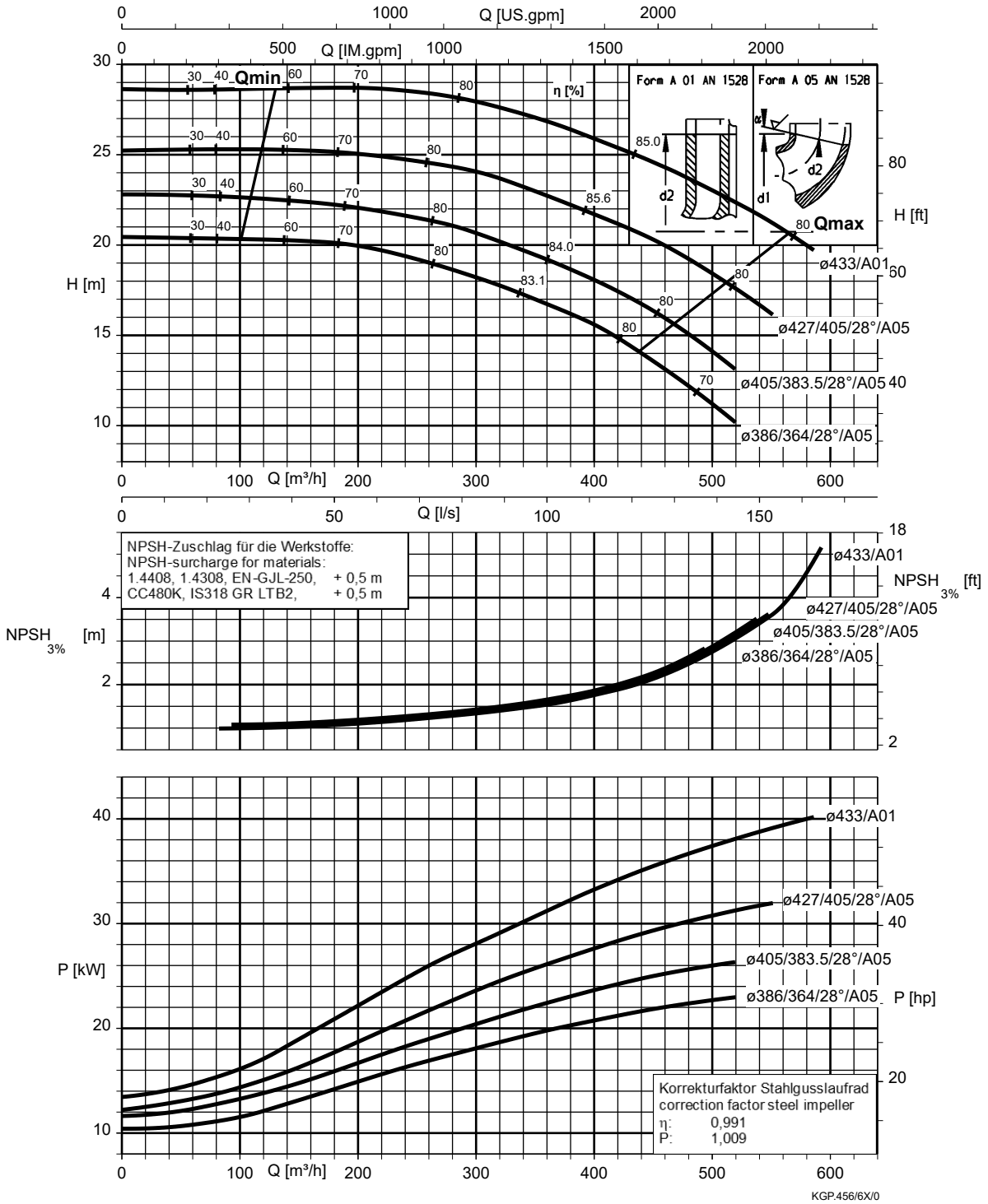



Vlet , Velta 250-200-510 , n = 960 rpm

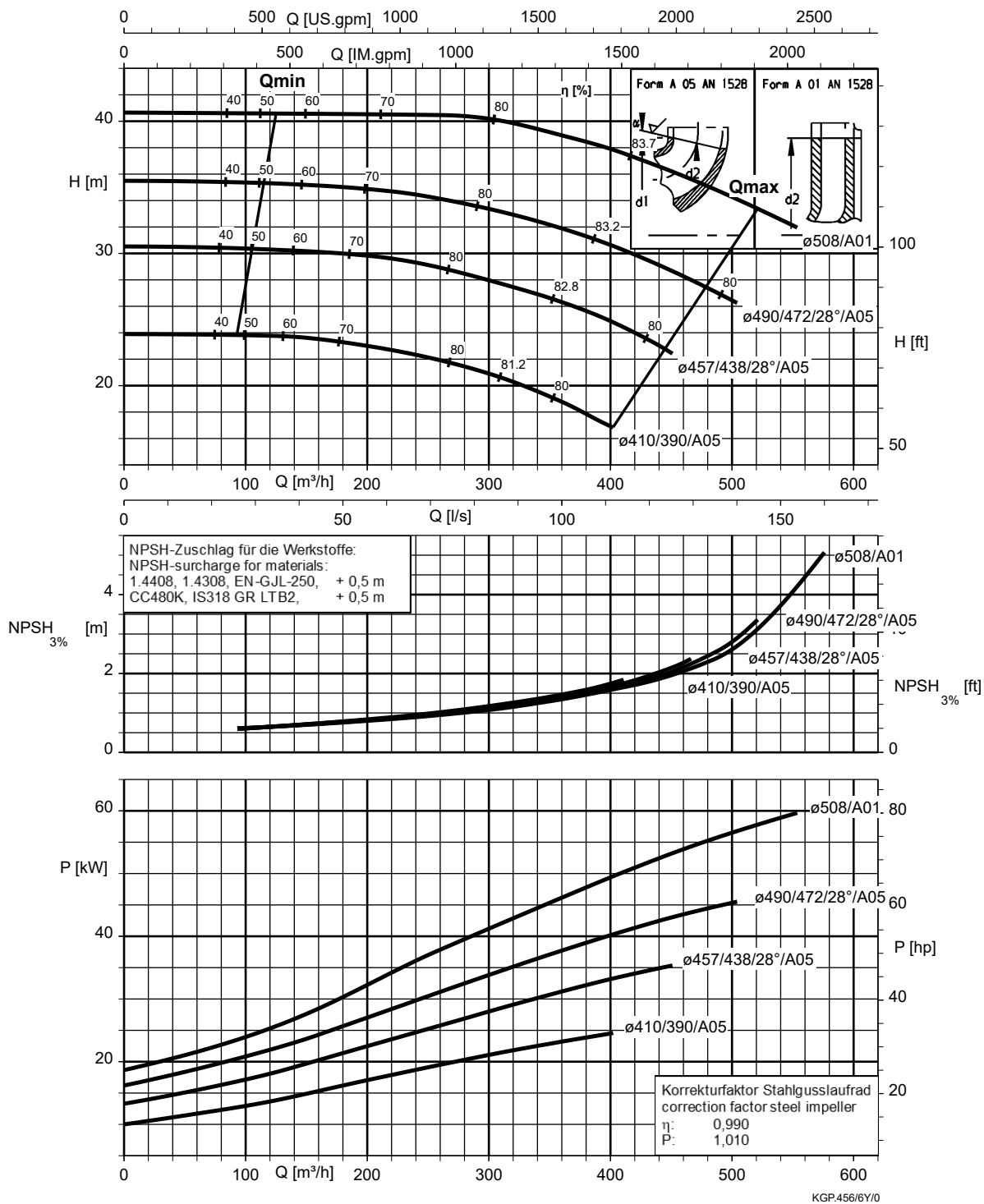

Vlet , Velta 300-250-295, n = 960 rpm

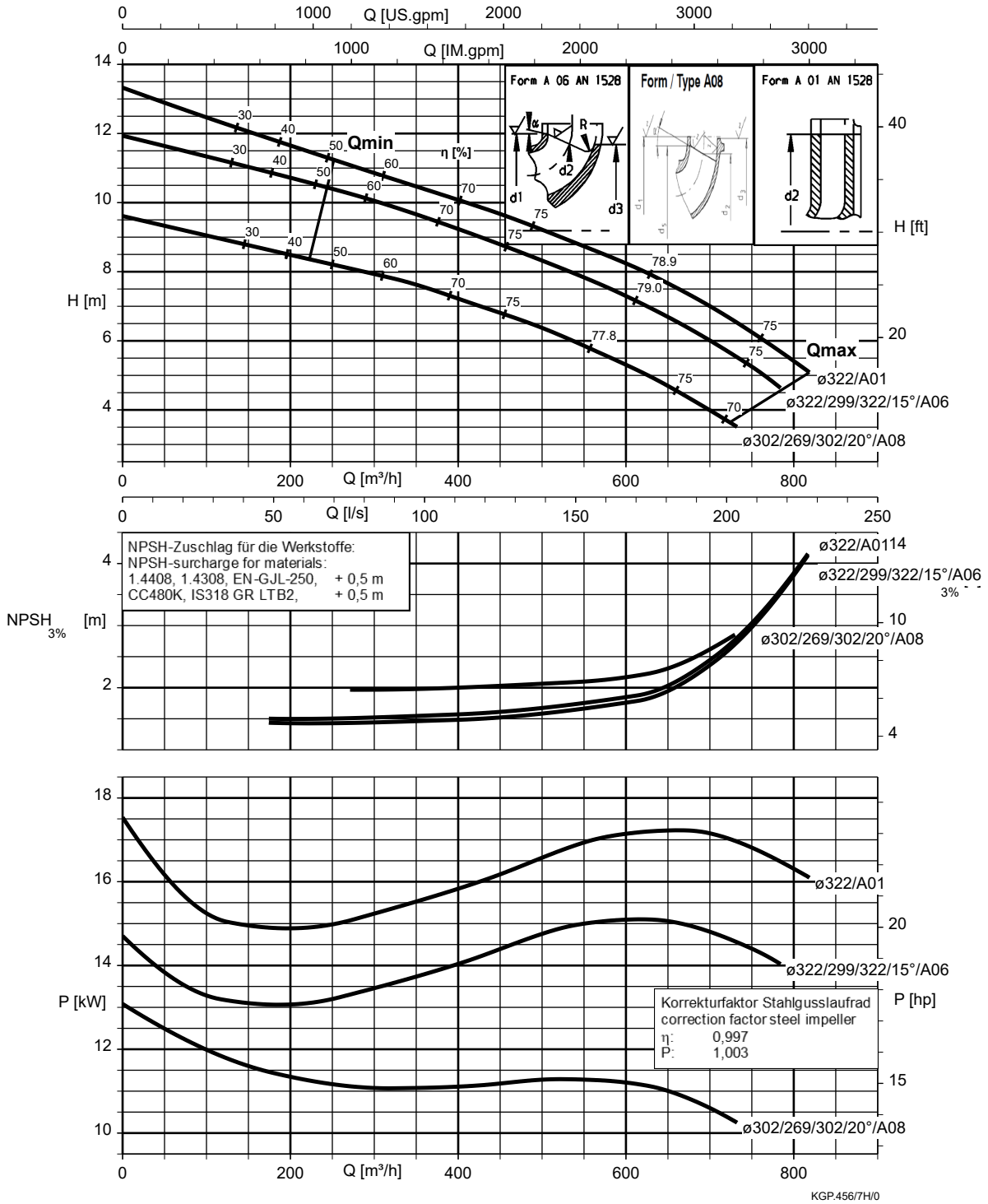

Vlet , Velta 300-250-295.1 , n = 960 rpm

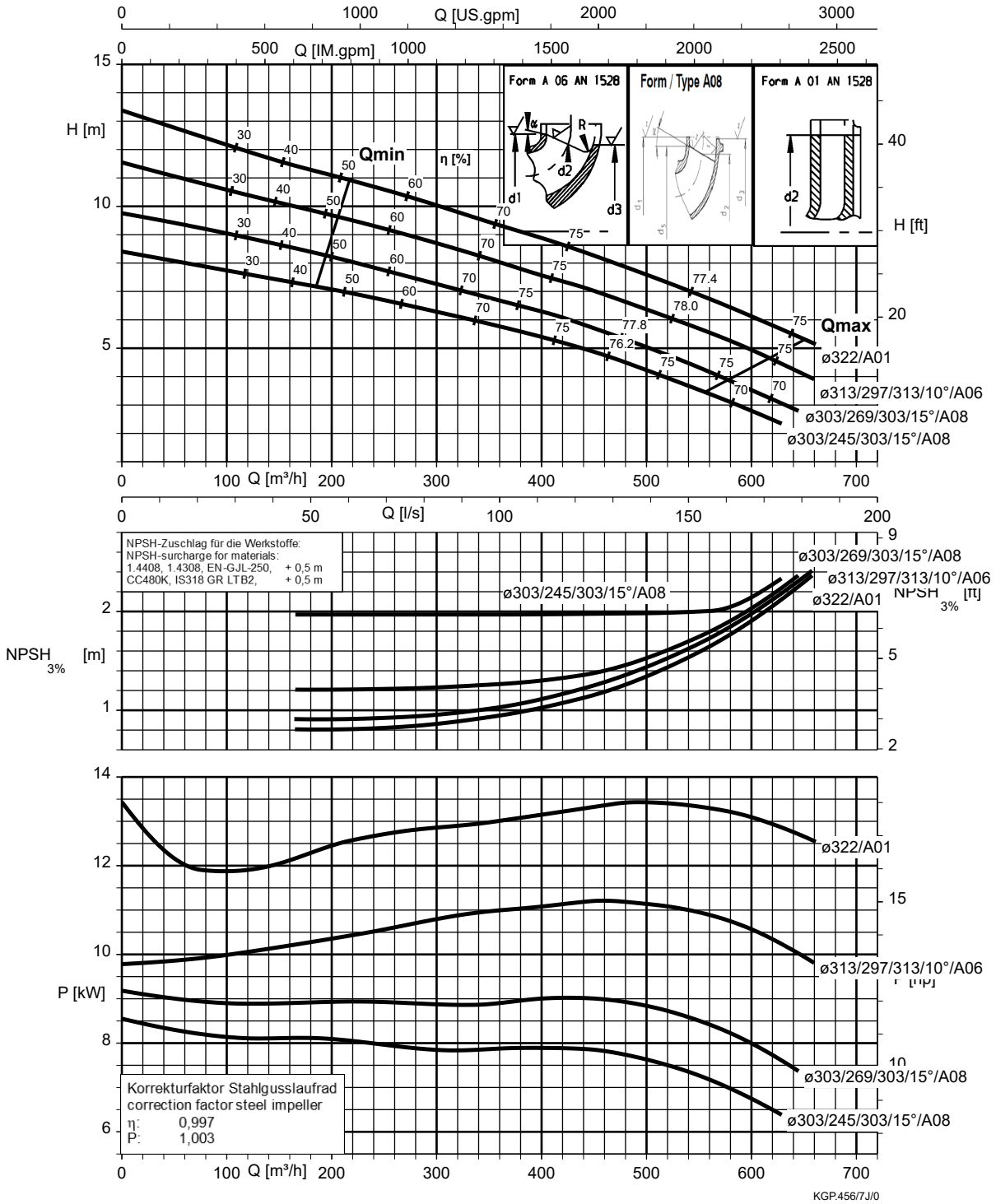

Vlet , Velta 300-250-320 , n = 960 rpm

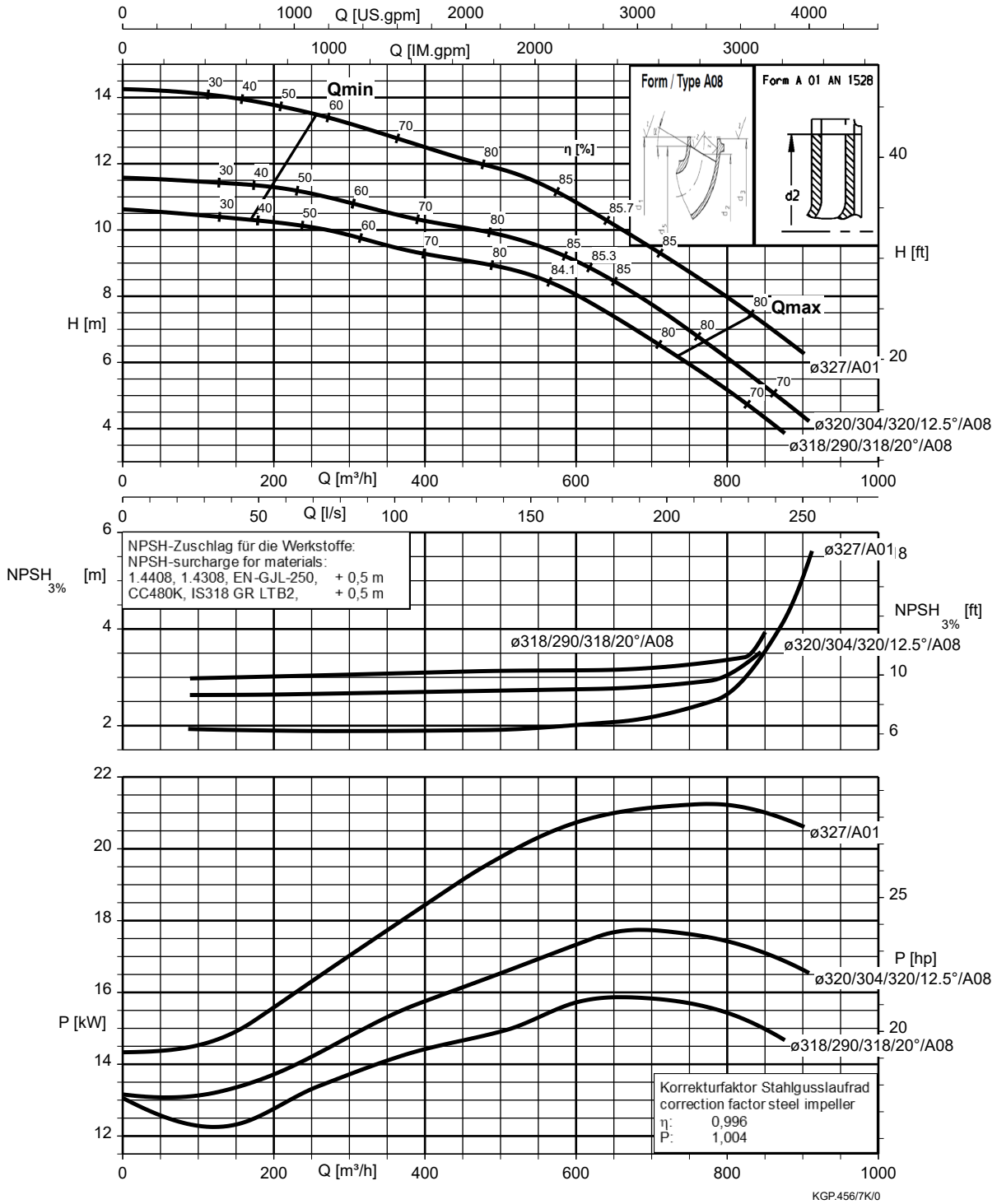

Vlet , Velta 300-250-375, n = 960 rpm

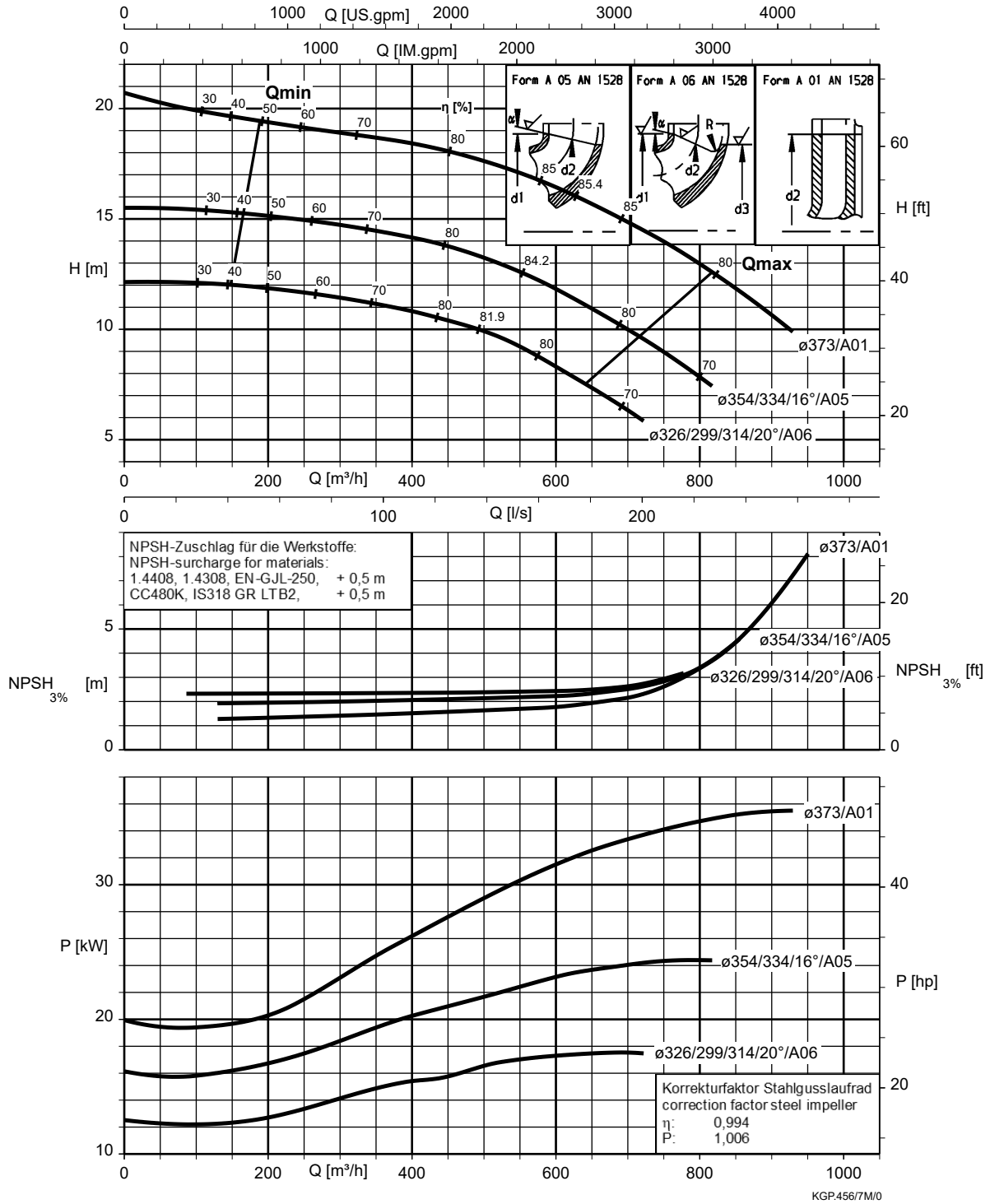

Vlet , Velta 300-250-435, n = 960 rpm

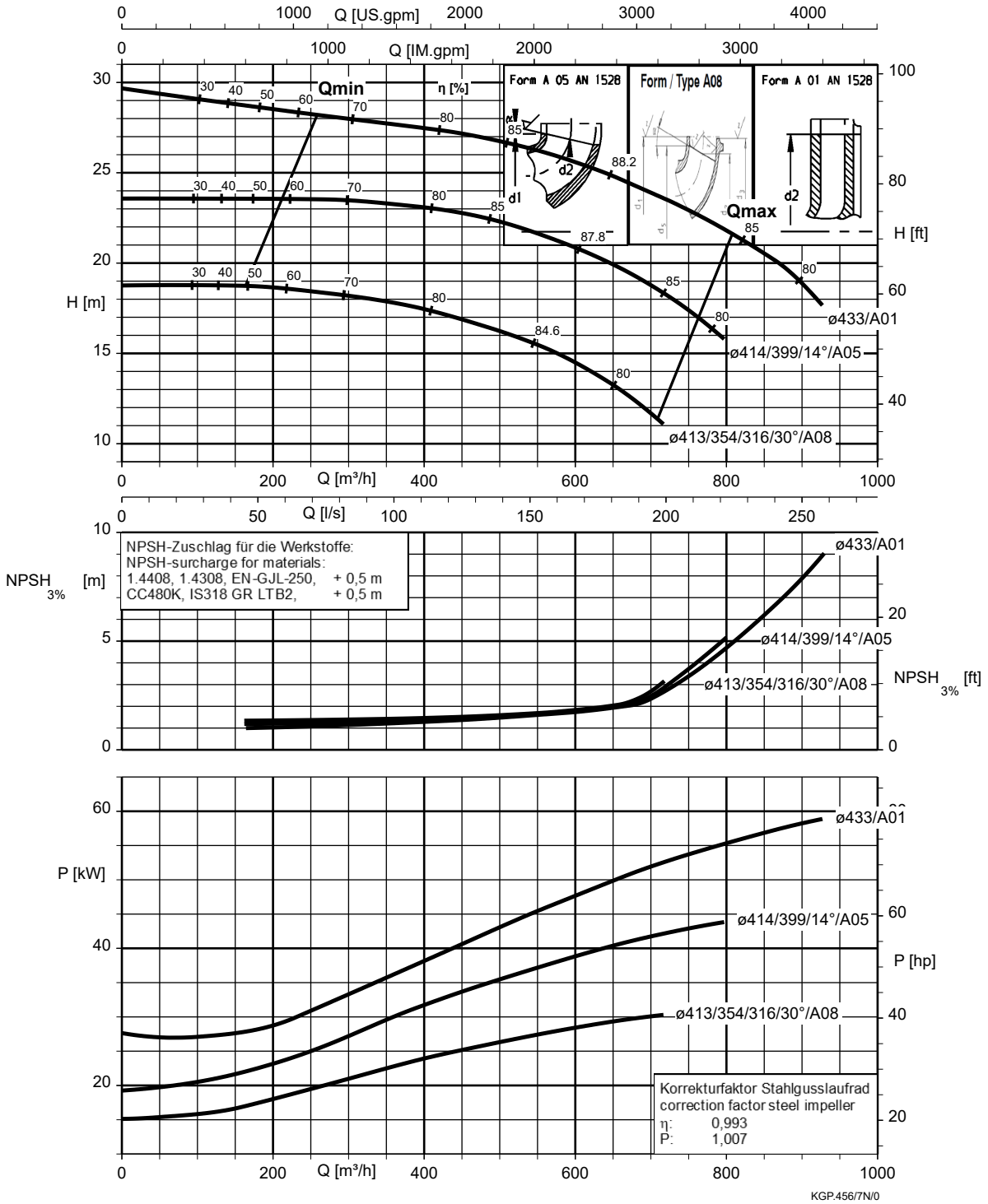

Vlet , Velta 300-250-510, n = 960 rpm

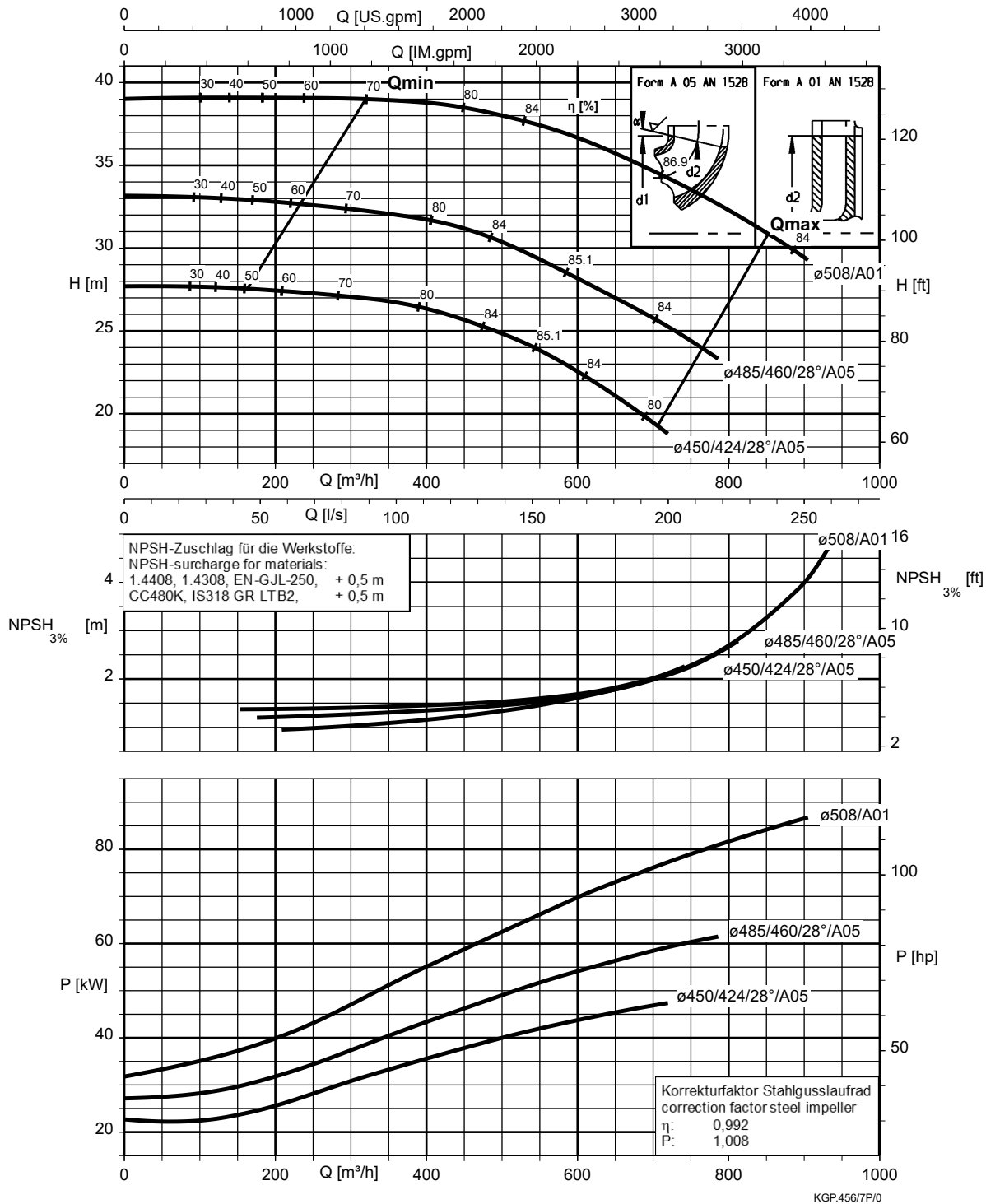

Vlet , Velta 350-300-350, n = 960 rpm

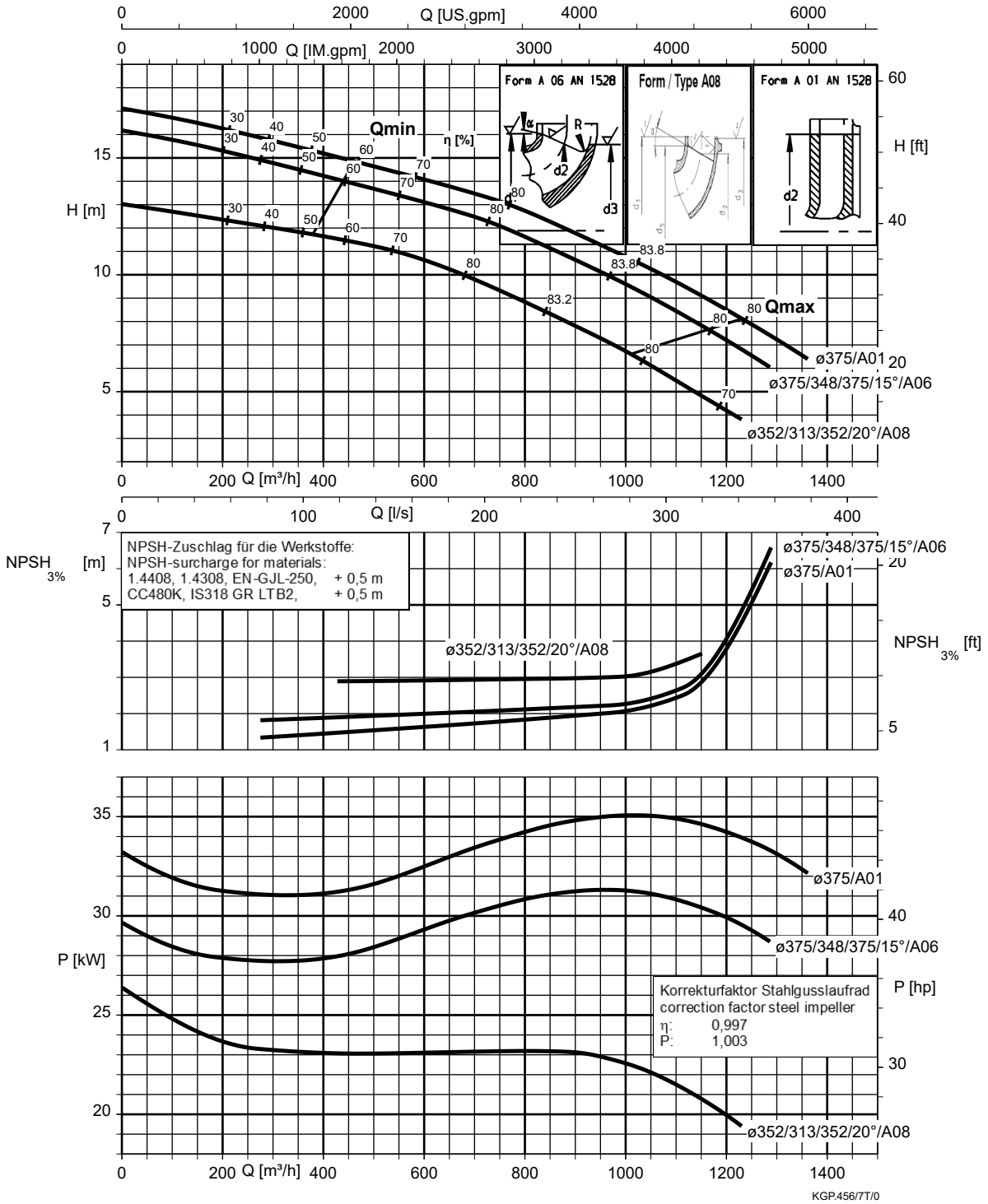



Vlet , Velta 350-300-350.1 , n = 960 rpm

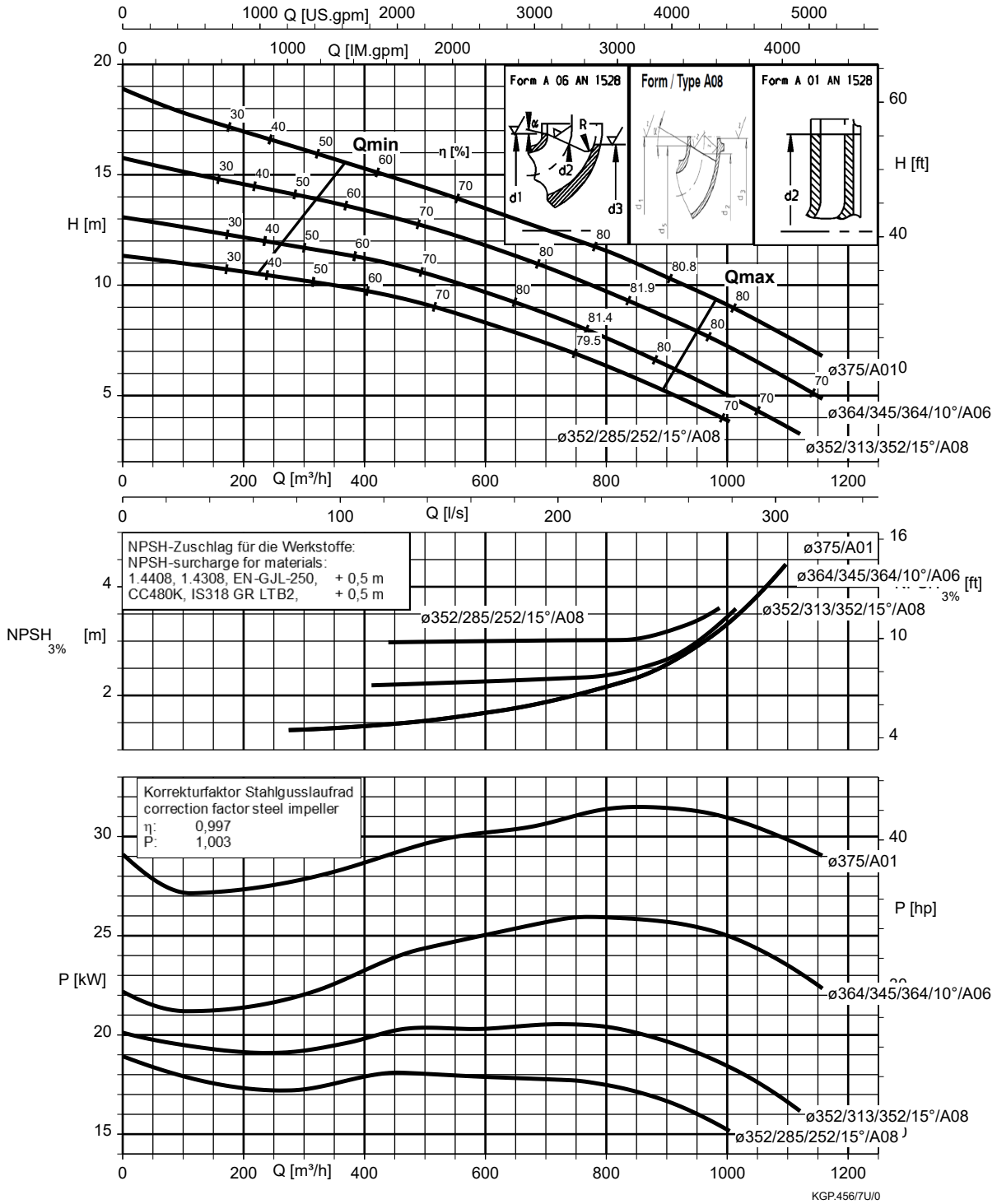

Vlet , Velta 350-300-375, n = 960 rpm

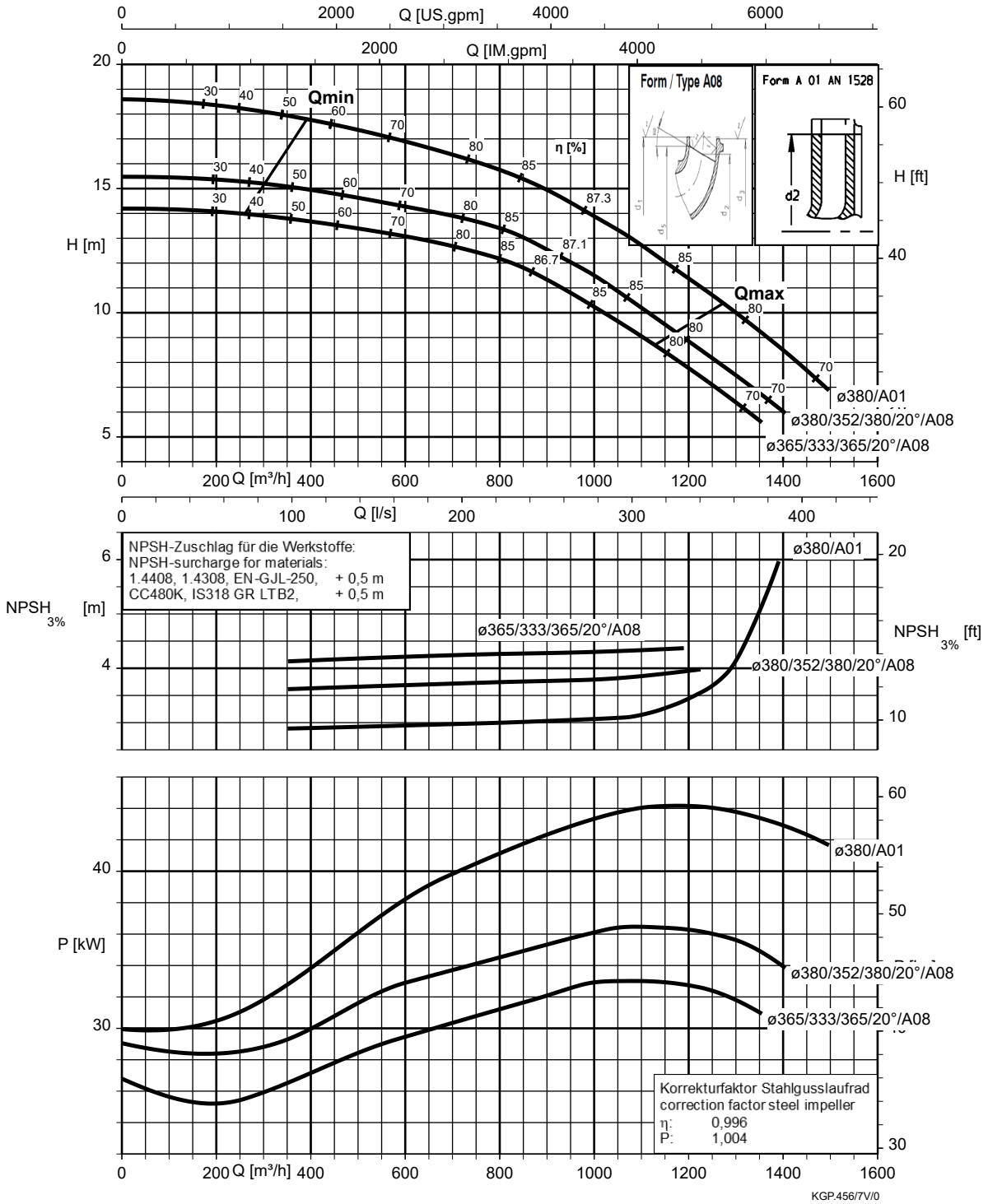

Vlet , Velta 350-300-435 , n = 960 rpm

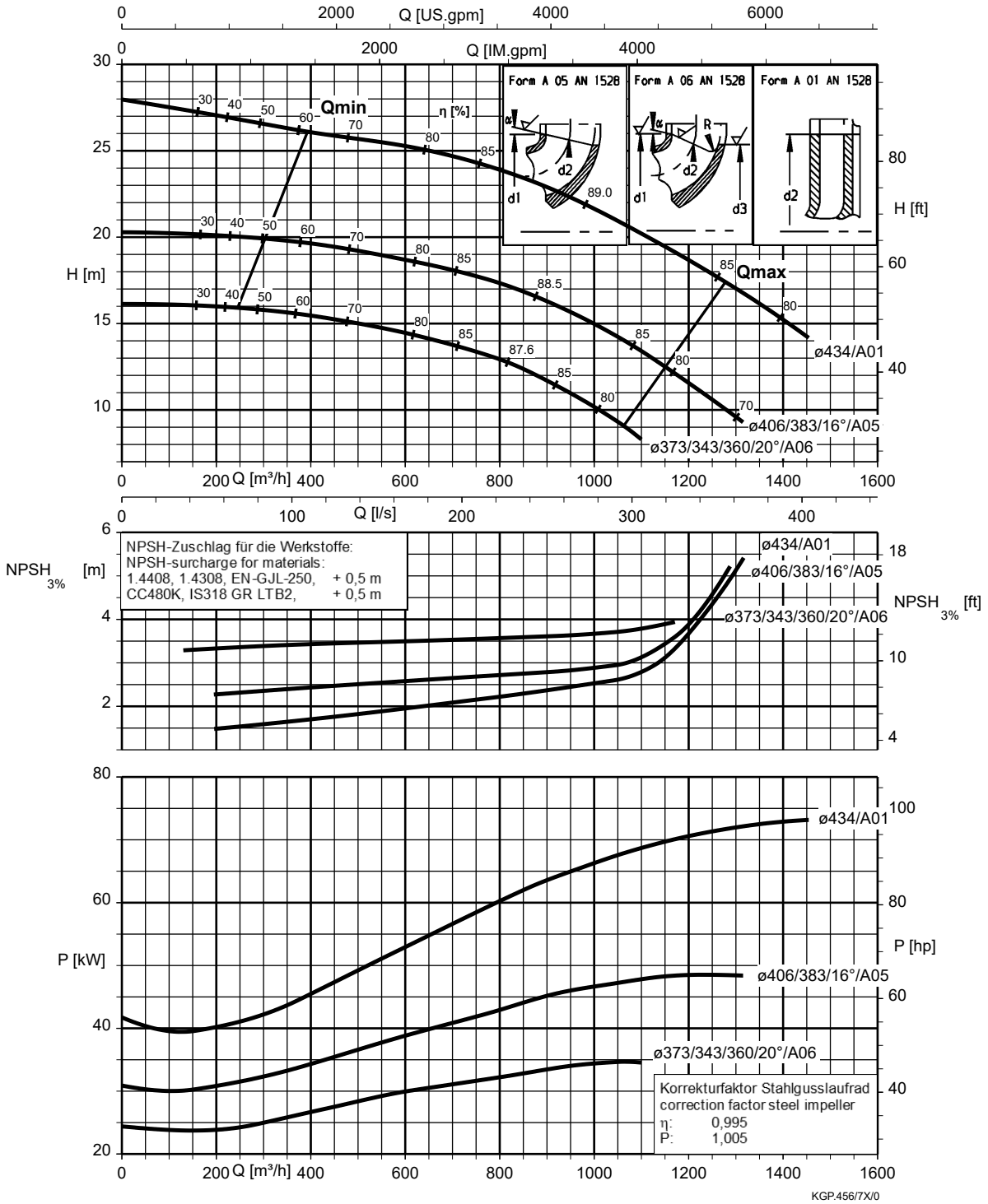

Vlet , Velta 350-300-510 , n = 960 rpm

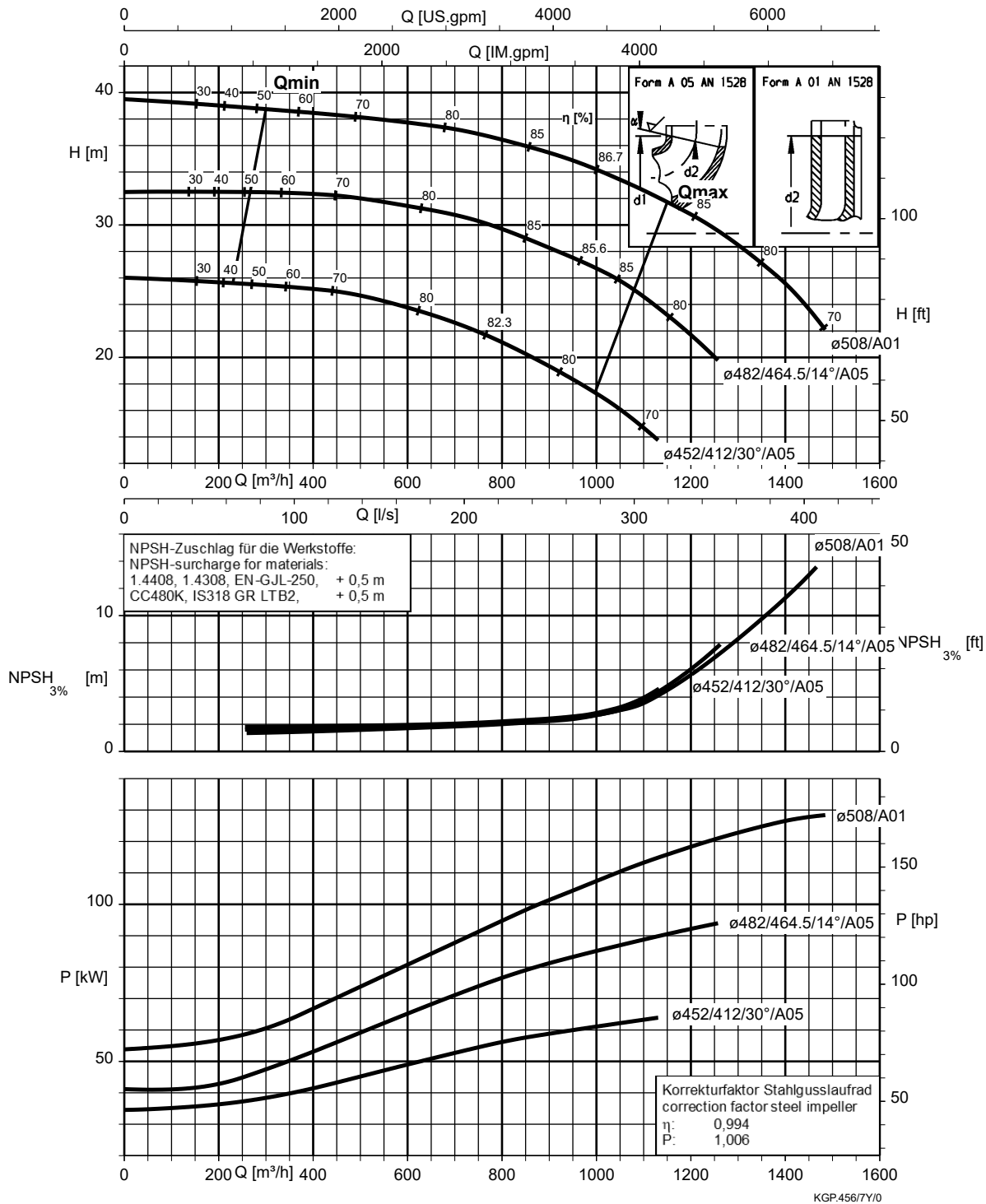

# DIMENSIONS - PUMP BARE SHAFT OUTLINE DRAWING

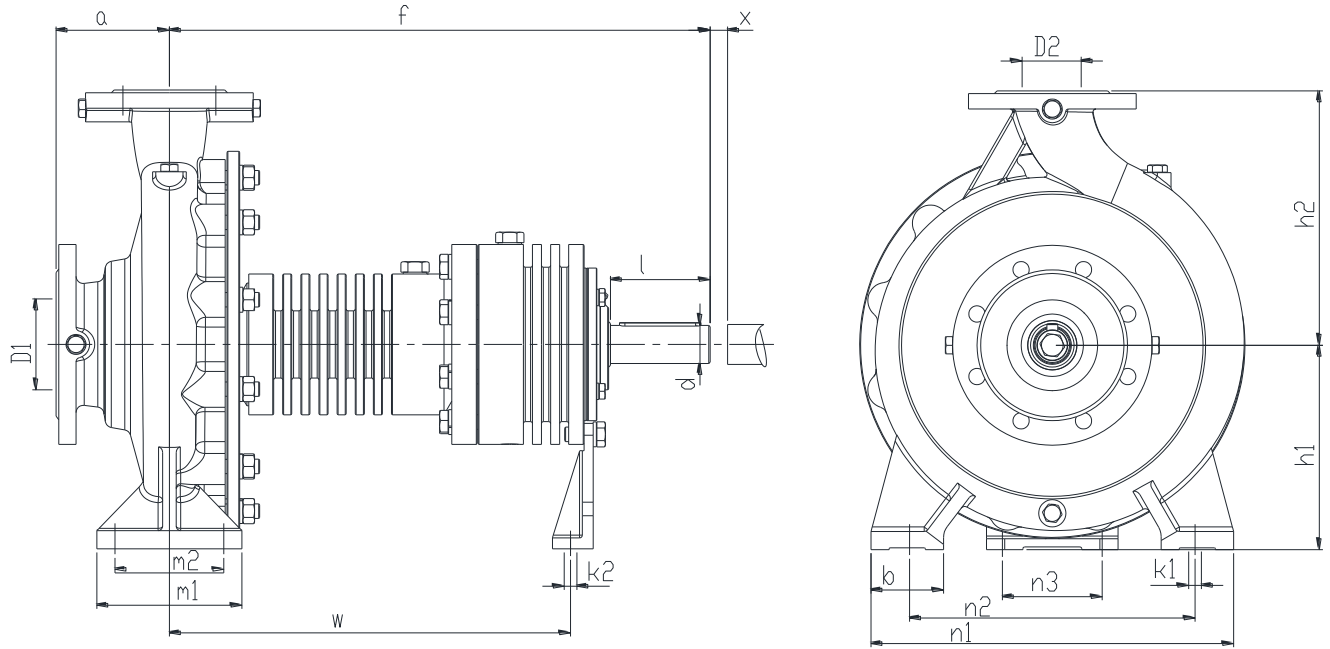

SIZE	Dimensions (mm)																	
	D1	D2	a	f	h1	h2	b	m1	m2	n1	n2	n3	w	x	d	l	k1	k2
32-125	50	32	80	485	112	140	50	100	70	190	140	110	285	100	24	50	M12	M12
32-160	50	32	80	485	132	160	50	100	70	240	190	140	285	100	24	50	M12	M12
32-200	50	32	80	485	160	180	50	100	70	240	190	140	285	100	24	50	M12	M12
32-250	50	32	100	600	180	225	65	125	95	320	250	190	370	100	32	80	M12	M12
40-160	65	40	80	485	132	160	50	100	70	240	190	140	285	100	24	50	M12	M12
40-200	65	40	100	485	160	180	50	100	70	265	212	165	285	100	24	50	M12	M12
40-250	65	40	100	600	180	225	65	125	95	320	250	190	370	100	32	80	M12	M12
40-315	65	40	125	600	200	250	65	125	95	345	280	215	370	100	32	80	M12	M12
50-160	80	50	100	485	160	180	50	100	70	265	212	165	285	100	24	50	M12	M12
50-200	80	50	100	485	160	200	50	100	70	265	212	165	285	100	24	50	M12	M12
50-250	80	50	125	600	180	225	65	125	95	320	250	190	370	100	32	80	M12	M12
50-315	80	50	125	600	225	280	65	125	95	345	280	215	370	100	32	80	M12	M12
65-160	100	65	100	600	160	200	65	125	95	280	212	150	370	100	32	80	M12	M12
65-200	100	65	100	600	180	225	65	125	95	320	250	190	370	140	32	80	M12	M12
65-250	100	65	125	600	200	250	80	160	120	360	280	200	370	140	32	80	M16	M12
65-315	100	65	125	630	225	280	80	160	120	400	315	240	370	140	42	110	M16	M12
80-160	125	80	125	600	180	225	65	125	95	320	250	190	370	140	32	80	M12	M12
80-200	125	80	125	600	180	250	65	125	95	345	280	215	370	140	32	80	M16	M12
80-250	125	80	125	600	225	280	80	160	120	400	315	240	370	140	32	80	M16	M12
80-315	125	80	125	630	250	315	80	160	120	400	315	240	370	140	42	110	M16	M12
100-200	125	100	125	600	200	280	80	160	120	360	280	200	370	140	32	80	M16	M12
100-250	125	100	140	630	225	280	80	160	120	400	315	240	370	140	42	110	M16	M12
100-315	125	100	140	630	250	315	80	160	120	400	315	240	370	140	42	110	M16	M12
125-250	150	125	140	630	250	355	80	160	120	400	315	240	370	140	42	110	M16	M12
125-315	150	125	140	630	280	355	100	200	150	500	400	300	370	140	42	110	M20	M12

# ASSEMBLY DRAWING WITH PART LIST

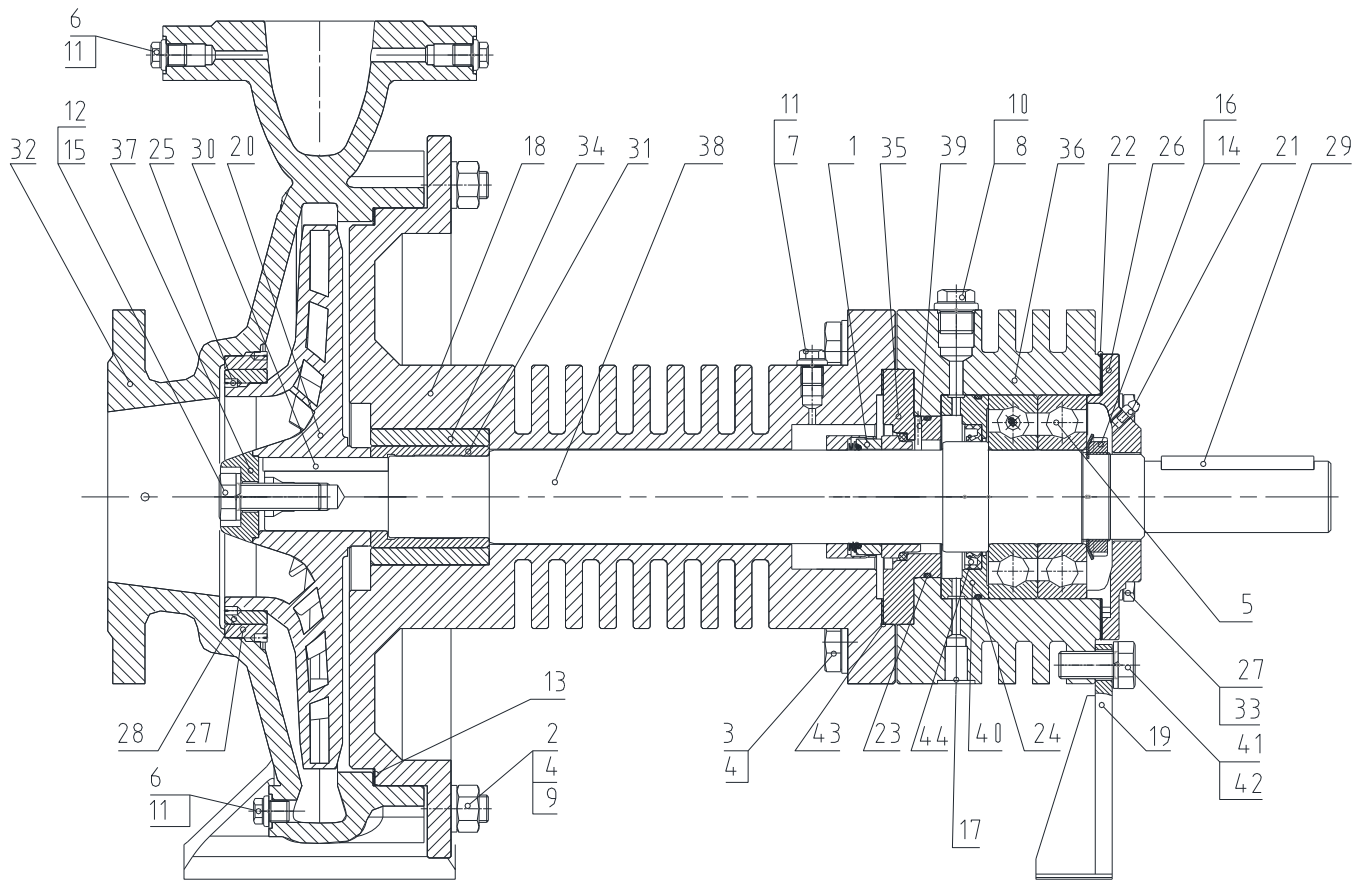

1	Mechanical seal	12	Impeller fixing screw	23	O-ring	34	Plate bearing
2	Nut	13	Gasket	24	O-ring	35	Mechanical seal cover
3	Screw	14	Lock nut	25	Screw for wearing rings fixing	36	Bearing bracket
4	Washer	15	Washer	26	Bearing cover	37	Disc
5	Ball bearings	16	Locking washer	27	Casing wearing ring	38	Shaft
6	Screw	17	Leakage connection R1/2"	28	Impeller wearing ring	39	Spring pin
7	Air venting crews	18	Volute casing cover	29	Key	40	Seat ring holder
8	Screw	19	Foot	30	Key	41	Screw
9	Screw	20	Impeller	31	Sleeve	42	Washer
10	Washer	21	Greaser	32	Volute casing	43	Gasket
11	Washer	22	Gasket	33	Washer	44	Lip seal

# PUMP EXPLODED VIEW

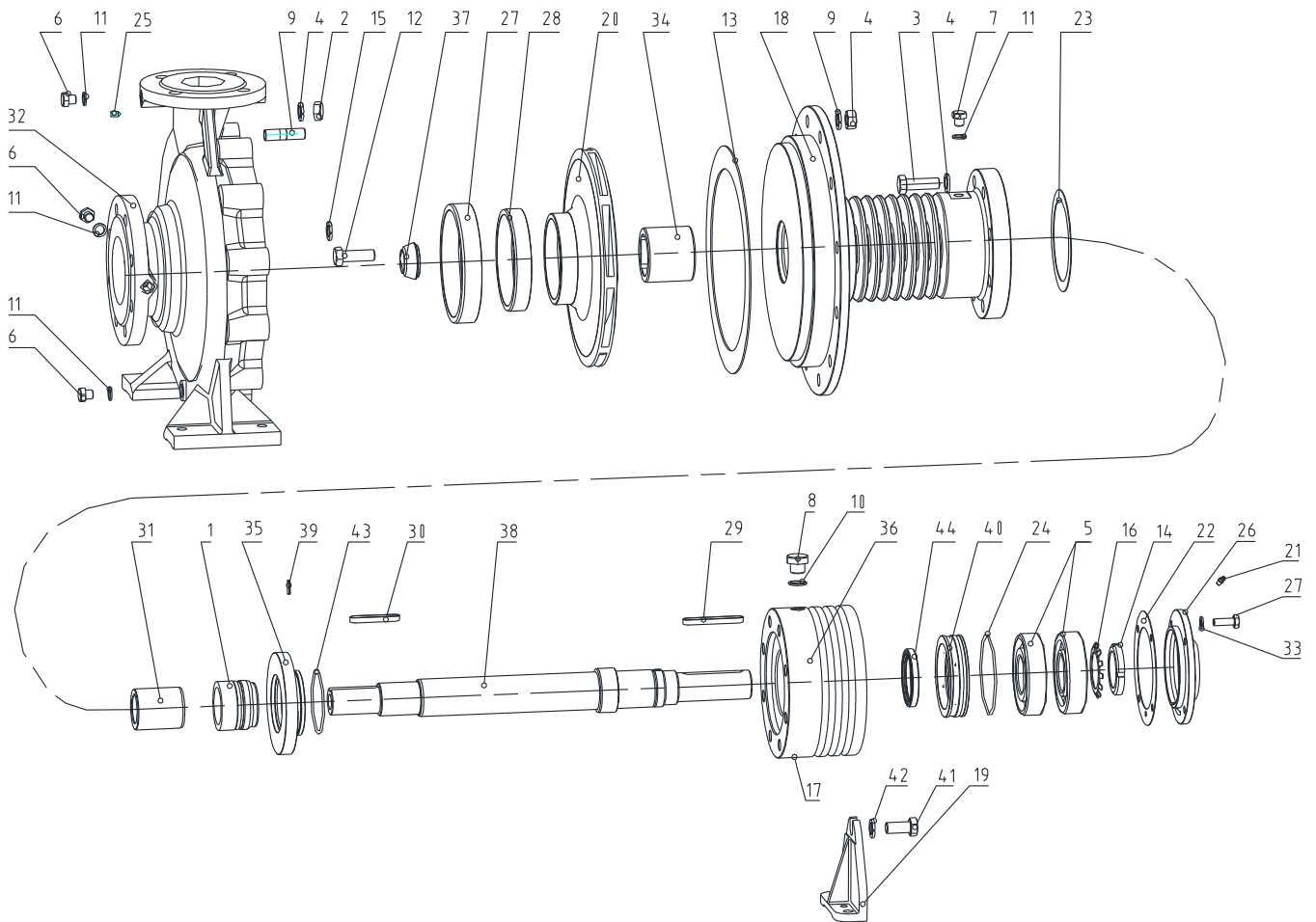

1	Mechanical seal	12	Impeller fixing screw	23	O-ring	34	Plate bearing
2	Nut	13	Gasket	24	O-ring	35	Mechanical seal cover
3	Screw	14	Lock nut	25	Screw for wearing rings fixing	36	Bearing bracket
4	Washer	15	Washer	26	Bearing cover	37	Disc
5	Ball bearings	16	Locking washer	27	Casing wearing ring	38	Shaft
6	Screw	17	Leakage connection	28	Impeller wearing ring	39	Spring pin
7	Air venting screw	18	Volute casing cover	29	Key	40	Seat ring holder
8	Screw	19	Foot	30	Key	41	Screw
9	Screw	20	Impeller	31	Sleeve	42	Washer
10	Washer	21	Greaser	32	Volute casing	43	Gasket
11	Washer	22	Gasket	33	Washer	44	Lip seal

[www.volcano-pump.com](http://www.volcano-pump.com)