

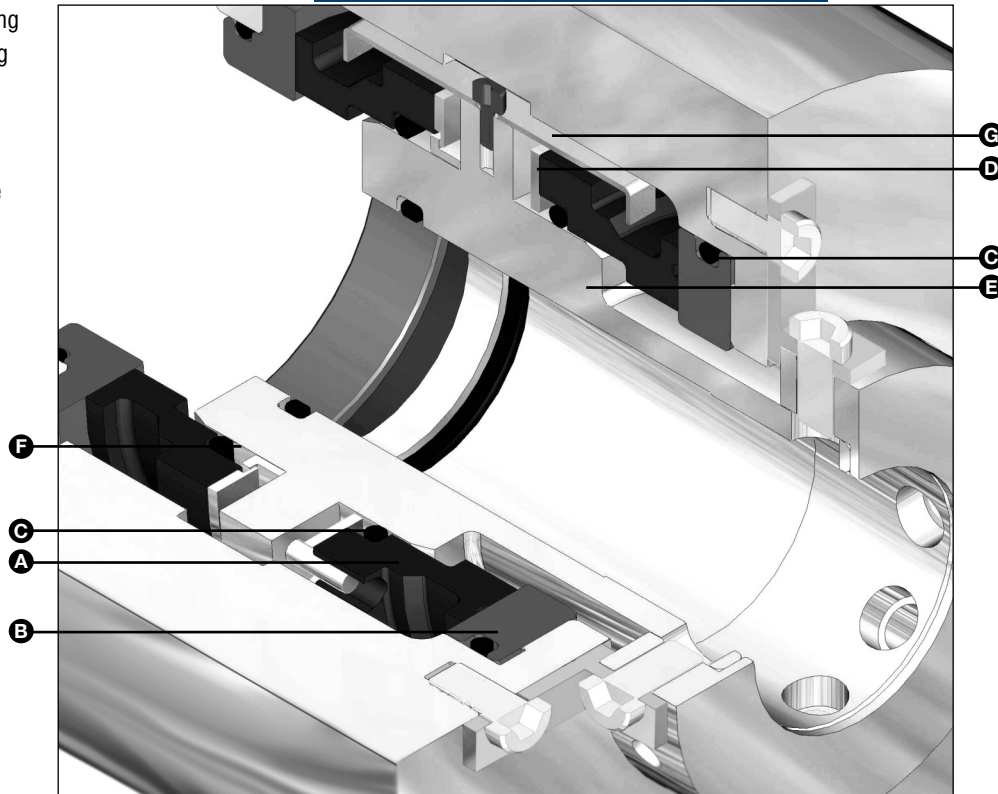

- A – Face/Primary Ring
- B – Seat/Mating Ring
- C – O-Ring
- D – Disc
- E – Sleeve
- F – Retaining Sleeve
- G – Retaining Clip



Patent numbers: 5,938,206 and 6,142,478

Product Description

The universal vessel seal (7800 Series) is a modular cartridge seal for use in a wide variety of mixing and agitating equipment and covering a broad application range. The 7828G and 7828GD are heavy duty, gas-lubricated double seals designed for top entry mixers. The universal vessel seal uses modular hardware that provides maximum interchangeability. Four combinations of seal face technology provide the user with unmatched flexibility and value.

- Type 7828G - Non-contacting, gas lubricated double seal uses dry nitrogen as a barrier gas and patented spiral groove technology to separate the primary seal faces eliminating contact and creating a wear free environment, which insures 100% product purity and no batch contamination. Patented features enable the seal to maintain lift-off in the presence of extreme radial runout and even angular misalignment of the seal faces. The cartridge is reverse pressure balanced and will remain closed in the event that barrier gas pressure is lost. Materials of construction are FDA approved.
- Type 7828GD - Where reduced barrier gas consumption is desirable, the 7828GD is a unique hybrid that offers a combination of non-contacting seal faces inboard and dry contacting faces outboard. Type 7828GD uses adaptive hardware that is identical to the 7828G.

Note: Modular bearing housing and debris well are optional on both seals.

Performance Capabilities

- Temperature: -40°F to 400°F/-40°C to 205°C
- Pressure: vacuum to 210 psig /14.5 bar g barrier pressure
- Speed: 0 to 400 fpm/2 m/s
- Axial movement: 0.093"/2.36mm max.
- Runout: 0.125"/3.18mm TIR

Design Features

- Patented grooved rotor allows equal lift in the presence of up to 0.125" radial runout.
- Patented primary ring shape responds under pressure, further enhancing very low speed face separation and lift-off.
- Double cartridge uses common springs, allowing for self-adjustment to axial motion.
- Optimized drive minimizes seal face to seal cartridge hardware interaction eliminating low speed hang-up.
- Completely modular design, the universal vessel seal offers maximum application flexibility.

TYPE 7828G/7828GD

7800 SERIES UNIVERSAL VESSEL SEAL

Type 7828G Typical Arrangement

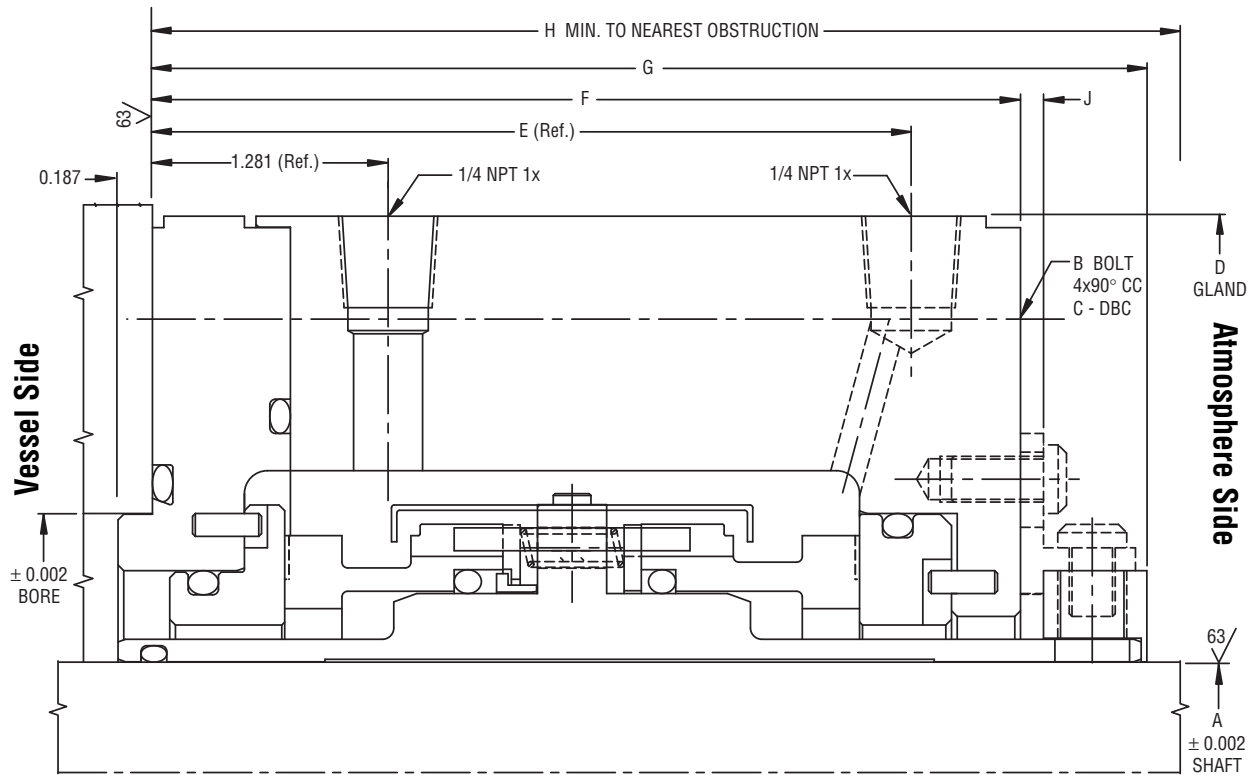

Type 7828G Dimensional Data (inches)

Shaft Size Range	A	B	C	D	E	F	G	H	J
Up to 1.500	1.500	0.375	4.625	5.343	3.375	3.968	4.656	4.781	0.094
1.625 – 2.000	2.000	0.500	5.500	6.500	4.125	4.718	5.437	5.562	0.125
2.125 – 2.500	2.500	0.500	6.000	7.000	4.125	4.718	5.437	5.562	0.125
2.625 – 3.000	3.000	0.500	6.500	7.500	4.125	4.718	5.437	5.562	0.125
3.125 – 3.500	3.500	0.500	7.000	8.000	4.125	4.718	5.437	5.562	0.125
3.625 – 4.000	4.000	0.500	7.500	8.500	4.125	4.718	5.437	5.562	0.125
4.125 – 4.500	4.500	0.500	8.000	9.000	4.125	4.718	5.437	5.562	0.125
4.625 – 5.000	5.000	0.500	9.000	9.875	4.125	4.718	5.437	5.562	0.125

Non-Contacting Operation

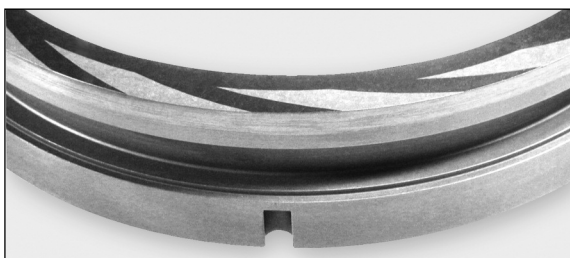

The Type 7828G universal vessel seal uses John Crane's patented spiral groove technology in a new and exciting way. The groove pattern is micro-machined into the carbon primary rings. The primary rings rotate with the shaft and generate consistent lift regardless of eccentric seal face tracking. Dry gas lubricated, non-contacting operation eliminates friction and wear insuring an ultra pure, ultra clean seal and process.

Applications requiring non-contacting technology, as well as extremely low barrier gas consumption, will benefit from the 7828GD. The 7828GD is a hybrid seal providing the process purity benefits of a spiral grooved inboard seal and a dry-running contacting seal on the atmospheric side.

TYPE 7828G/7828GD

7800 SERIES UNIVERSAL VESSEL SEAL

Type 7828GD Typical Arrangement

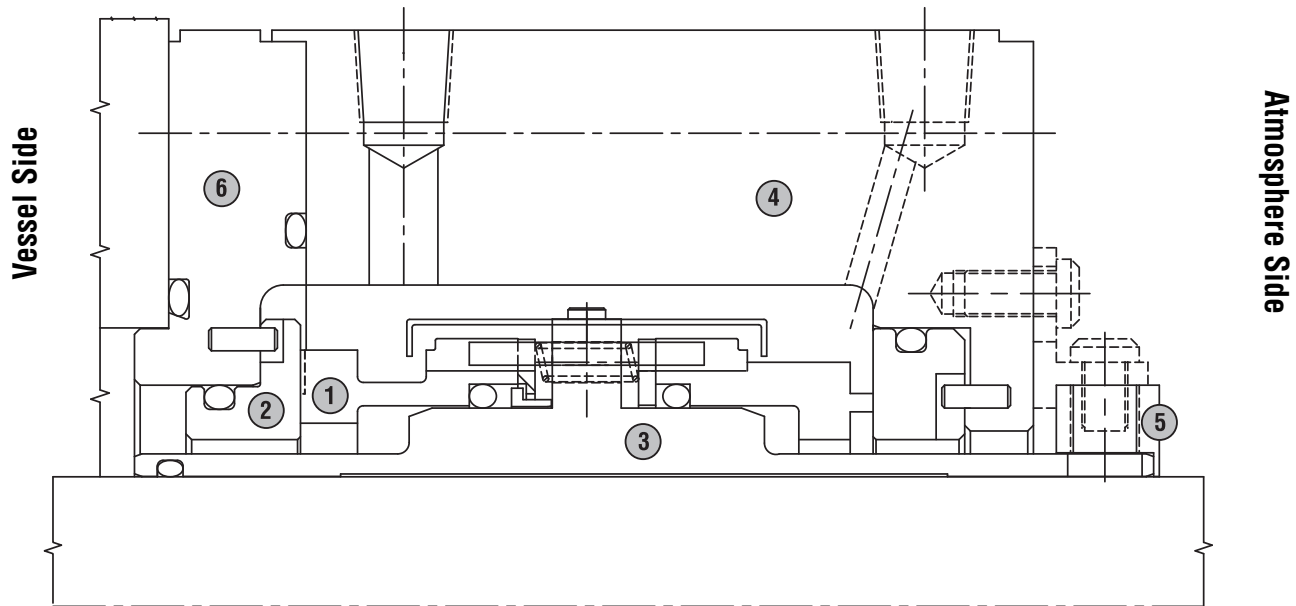

Materials of Construction

SEAL COMPONENTS	MATERIALS	
	Standard	Options
① Face/Primary Ring	Carbon	—
② Seat/Mating Ring	Silicon Carbide	Tungsten Carbide
③ Sleeve	316 Stainless Steel	Alloy C-276
④ Gland Plate	316 Stainless Steel	Alloy C-276
⑤ Collar	316 Stainless Steel	Alloy C-276
⑥ Inner Gland	316 Stainless Steel	Alloy C-276
O-ring	Fluoroelastomer	Perfluoroelastomer, EPDM

Type 7828G With Debris Well Typical Arrangement

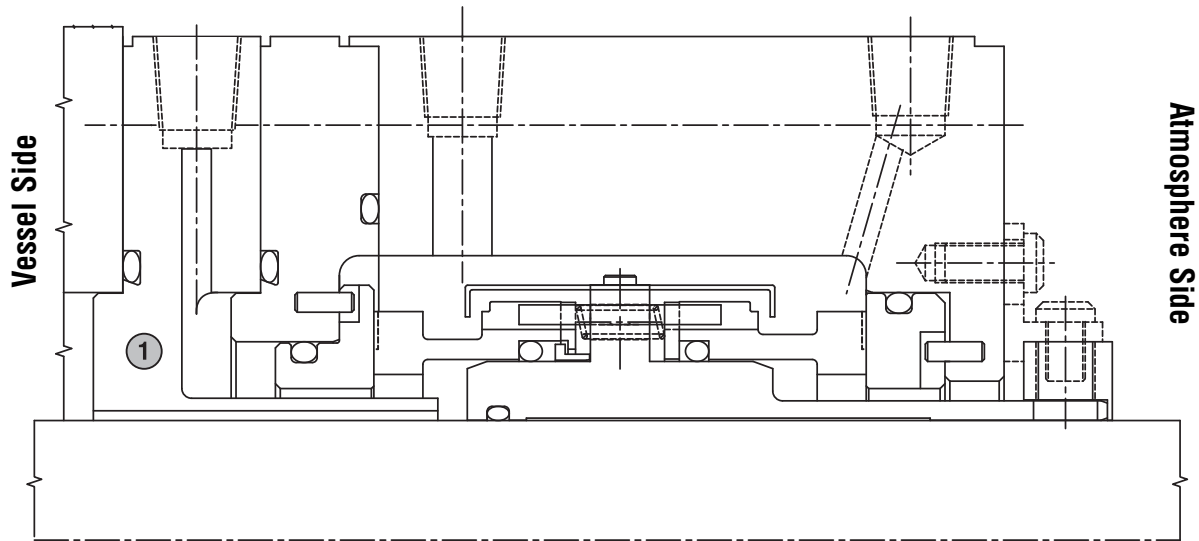

The debris well ① option is fully modular and available where applications demand periodic cleaning and product purity assurances.

Type 7828G With Bearing Housing Typical Arrangement

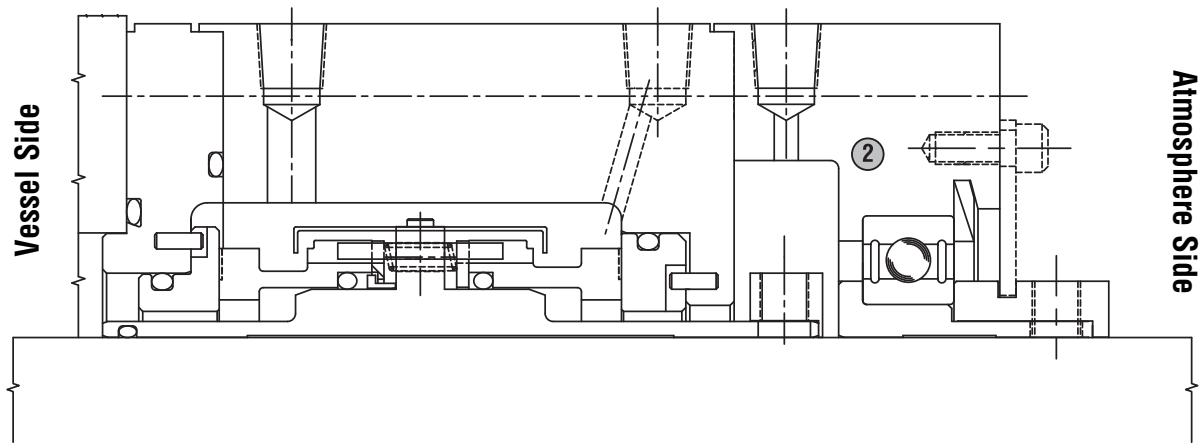

The bearing housing ② is a modular option available where additional shaft stability is desired.

TYPE 7828G/7828GD

7800 SERIES UNIVERSAL VESSEL SEAL

Estimated Total Leakage

Type 7828G Estimated Total Barrier Gas Consumption

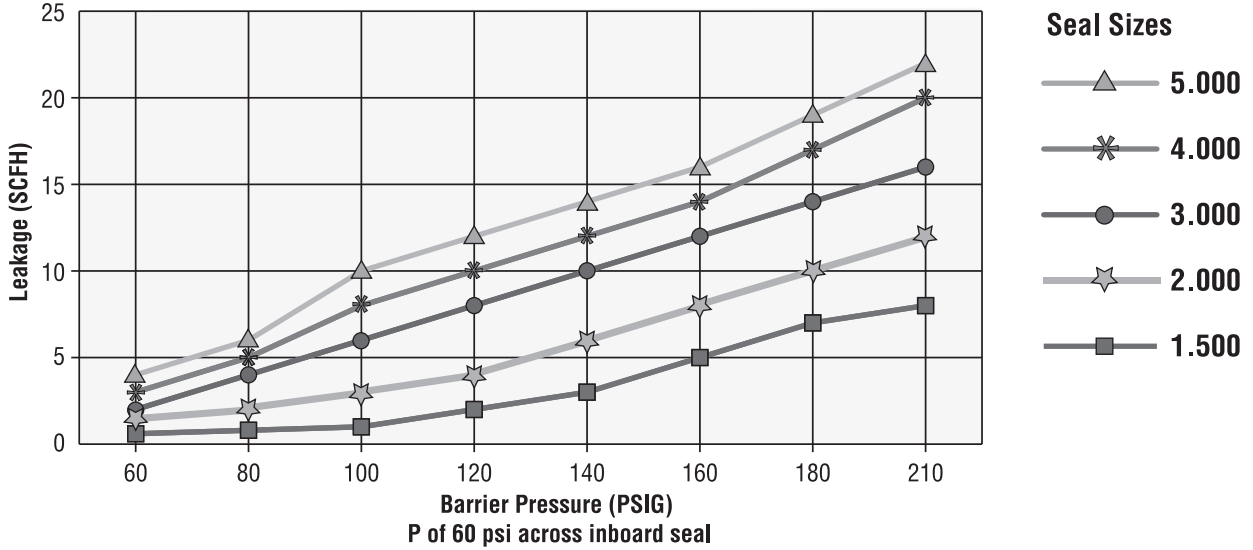

Note: 30% of total barrier gas passes inboard
70% to atmosphere

Type 7828GD Estimated Total Barrier Gas Consumption

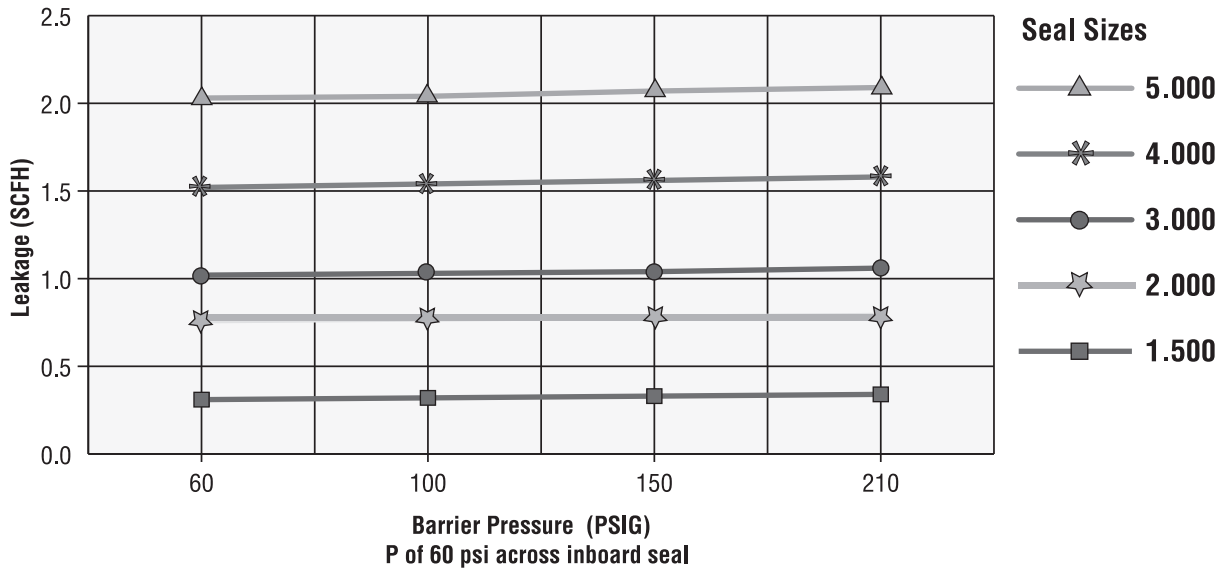

TYPE 7828G/7828GD

7800 SERIES UNIVERSAL VESSEL SEAL

Type 7828G/7828GD Seal Support Gas Panel

The diagram below shows a typical Type 7828G/7828GD support panel. The instrumentation pictured is intended to provide maximum insight regarding vessel pressure and seal cartridge control. Instrumentation and control preferences vary among end users. Vessel pressure sensing and tracking,

as well as real time adjustment of barrier gas pressure on the seal cartridge, work to prevent upsets.

Contact John Crane with specific requirements.

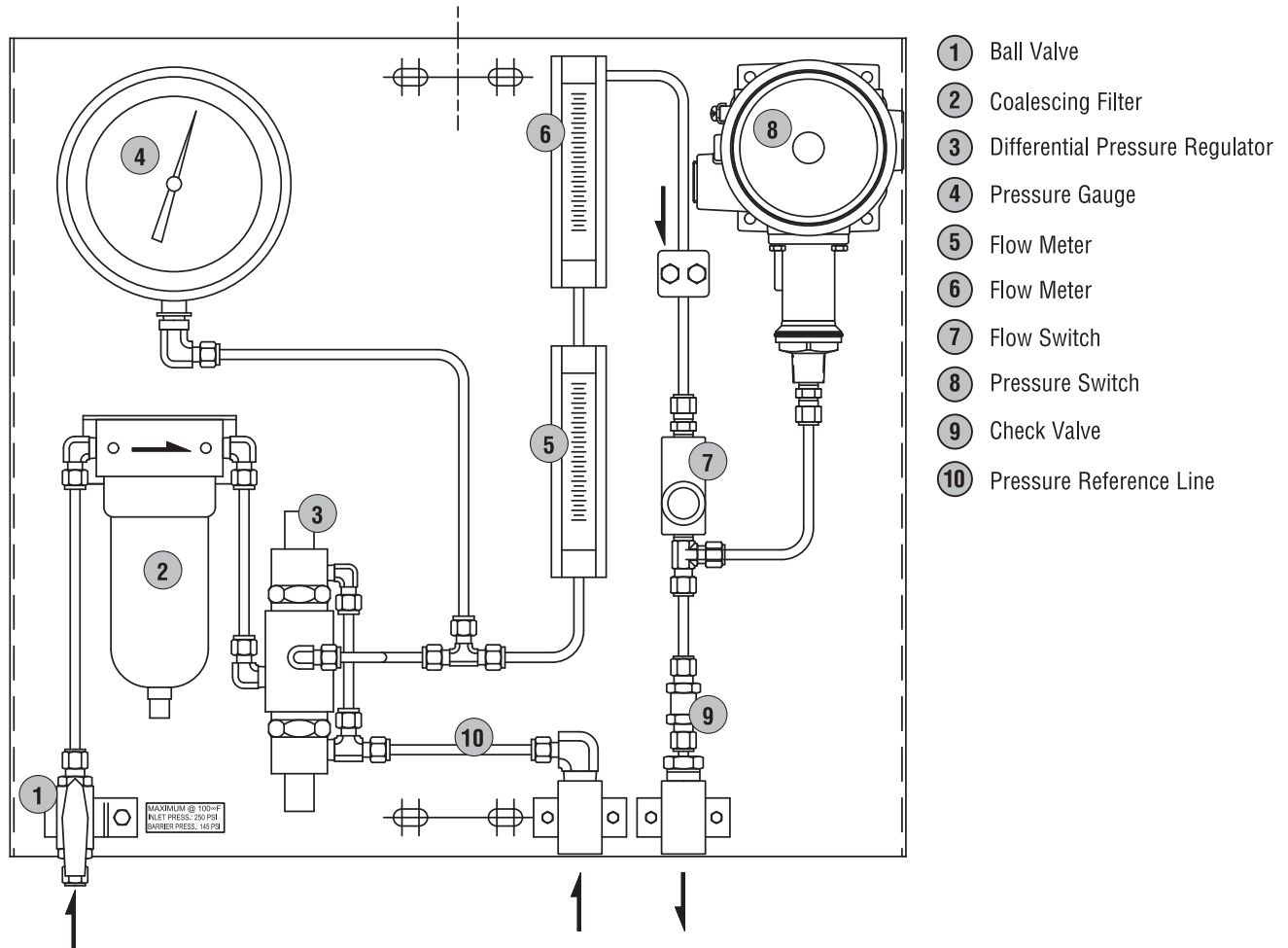

john crane

TYPE 7828G/7828GD

7800 SERIES UNIVERSAL VESSEL SEAL

Technical Specification

TYPE 7828G/7828GD

7800 SERIES UNIVERSAL VESSEL SEAL

Technical Specification



North America
 United States of America
 Tel: 1-847-967-2400
 Fax: 1-847-967-3915

Europe
 United Kingdom
 Tel: 44-1753-224000
 Fax: 44-1753-224224

Latin America
 Brazil
 Tel: 55-11-3371-2500
 Fax: 55-11-3371-2599

Middle East & Africa
 United Arab Emirates
 Tel: 971-481-27800
 Fax: 971-488-62830

Asia Pacific
 Singapore
 Tel: 65-6518-1800
 Fax: 65-6518-1803

If the products featured will be used in a potentially dangerous and/or hazardous process, your John Crane representative should be consulted prior to their selection and use. In the interest of continuous development, John Crane Companies reserve the right to alter designs and specifications without prior notice. It is dangerous to smoke while handling products made from PTFE. Old and new PTFE products must not be incinerated. ISO 9001 and ISO14001 Certified, details available on request.